

US00D504564S

(12) **United States Design Patent**
Robertson, Jr. et al.

(10) **Patent No.:** **US D504,564 S**
(45) **Date of Patent:** **** May 3, 2005**

(54) **HOLSTER FOR A COMMUNICATION DEVICE**

D466,287 S * 12/2002 Tanaka D3/218
D496,529 S * 9/2004 Gotou D3/218
D497,713 S * 11/2004 Lodato et al. D3/218

(75) Inventors: **William H. Robertson, Jr.**, Fort Lauderdale, FL (US); **Franco Lodato**, Weston, FL (US); **John Kelley**, Sunnyvale, CA (US)

* cited by examiner

Primary Examiner—Catherine R. Oliver
(74) *Attorney, Agent, or Firm*—Design IP

(73) Assignee: **Motorola, Inc.**, Schaumburg, IL (US)

(57) **CLAIM**

(**) Term: **14 Years**

The ornamental design for a holster for a communication device, as shown and described.

(21) Appl. No.: **29/205,229**

DESCRIPTION

(22) Filed: **May 11, 2004**

FIG. 1 is an isometric view of a holster for a communication device showing our new design.

(51) **LOC (7) Cl.** **03-01**

FIG. 2 is a front elevation view thereof.

(52) **U.S. Cl.** **D3/218**

FIG. 3 is a rear elevation view thereof.

(58) **Field of Search** D3/218; D14/248,

FIG. 4 is a left side elevation view thereof.

D14/253, 138, 185, 251–252; 455/575.1–575.8;

FIG. 5 is a right side elevation view thereof.

379/446, 455; 224/640, 646, 940

FIG. 6 is a top plan view thereof; and,

FIG. 7 is a bottom plan view thereof.

(56) **References Cited**

The broken lines shown in FIGS. 1–7 are included for the purpose of illustrating environmental elements only and form no part of the claimed design.

U.S. PATENT DOCUMENTS

6,345,751 B1 * 2/2002 Elliot 224/646

D457,309 S * 5/2002 Tanaka D3/218

1 Claim, 5 Drawing Sheets

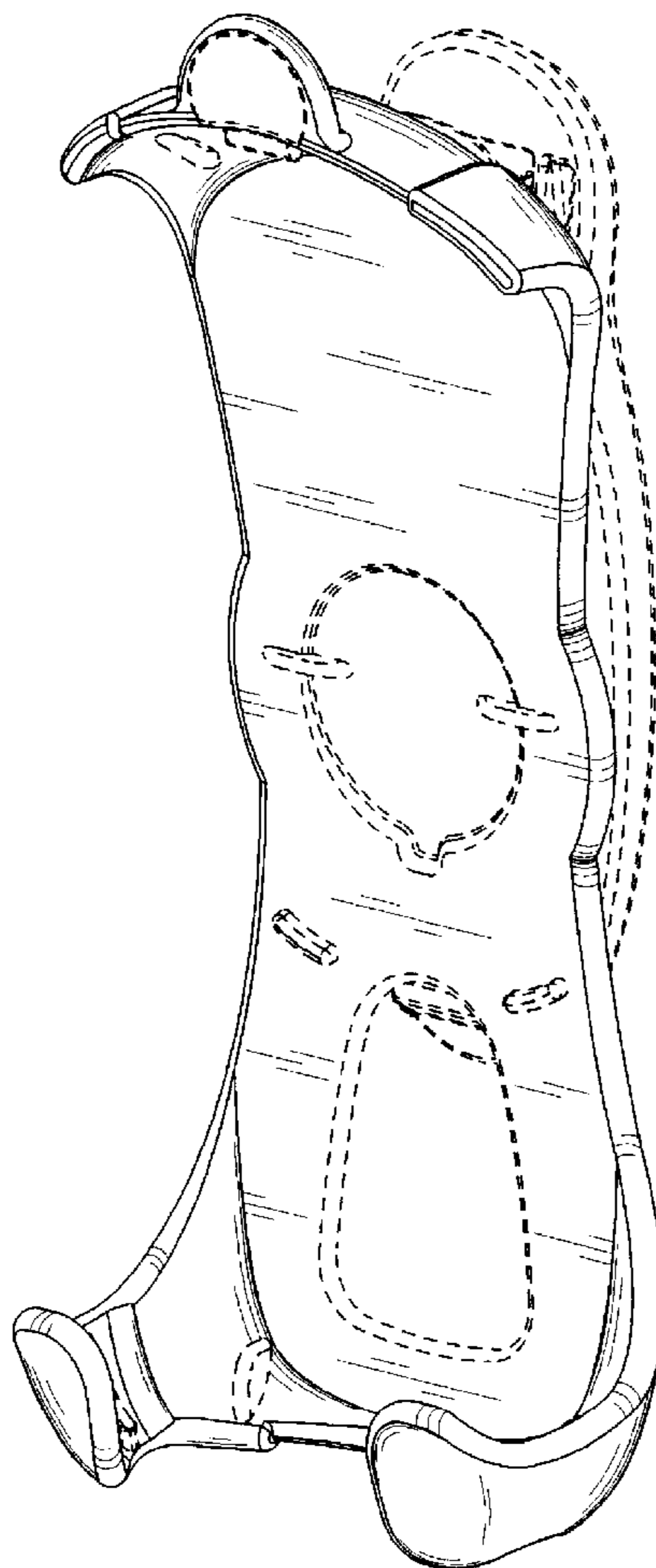

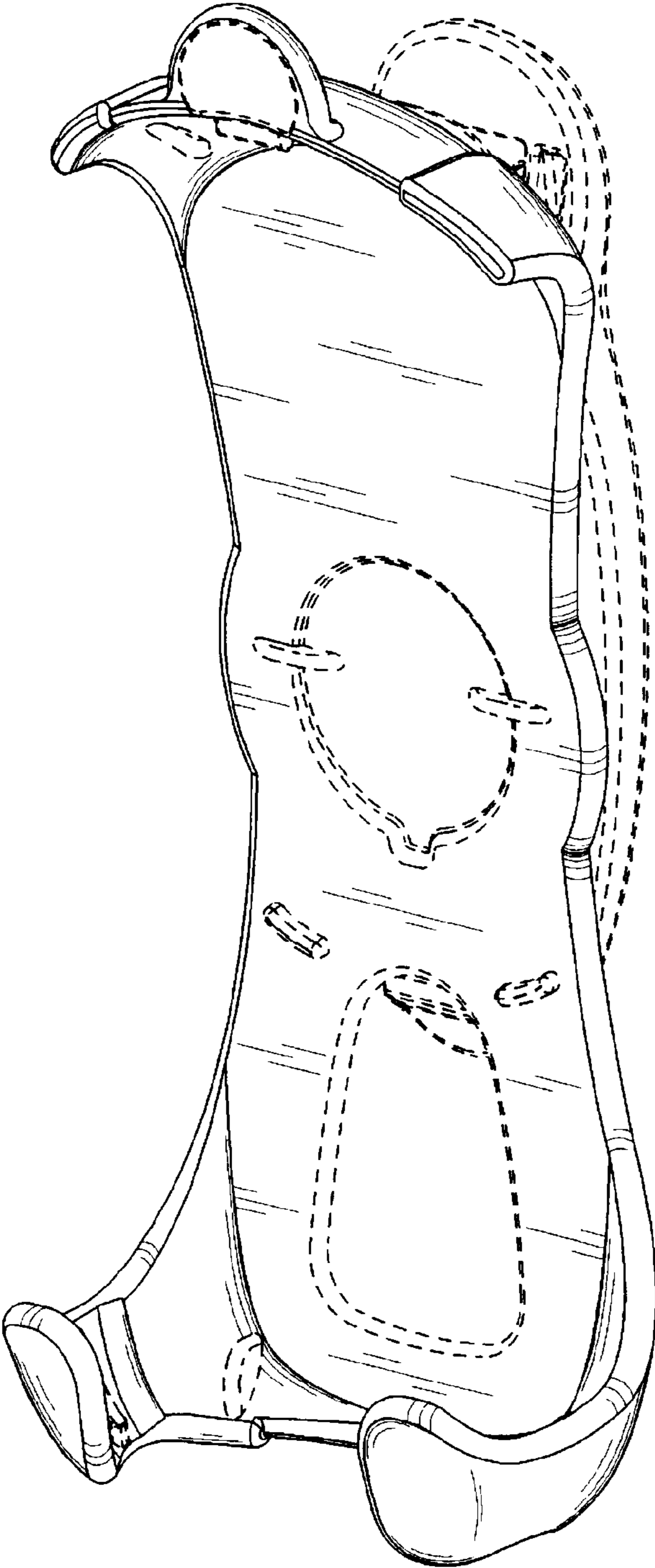

FIG. 1

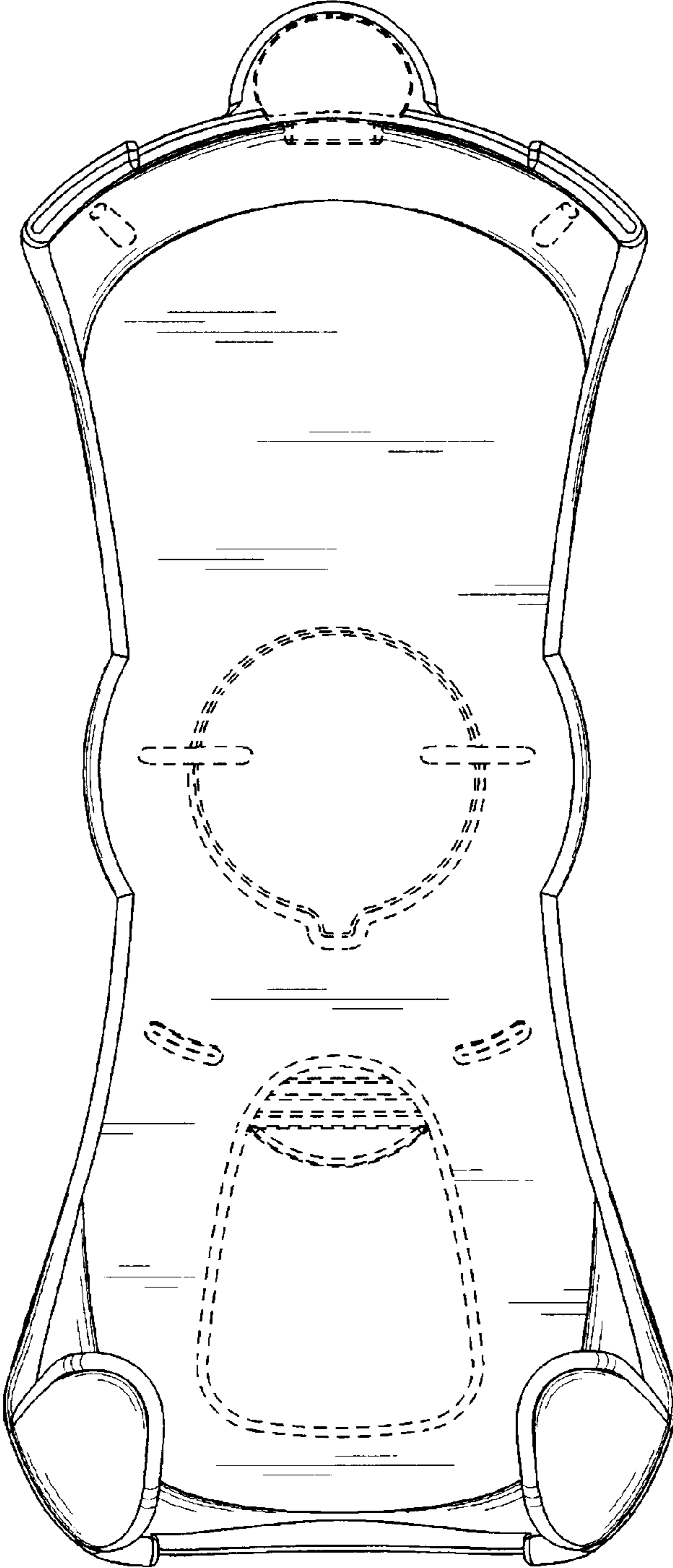

FIG. 2

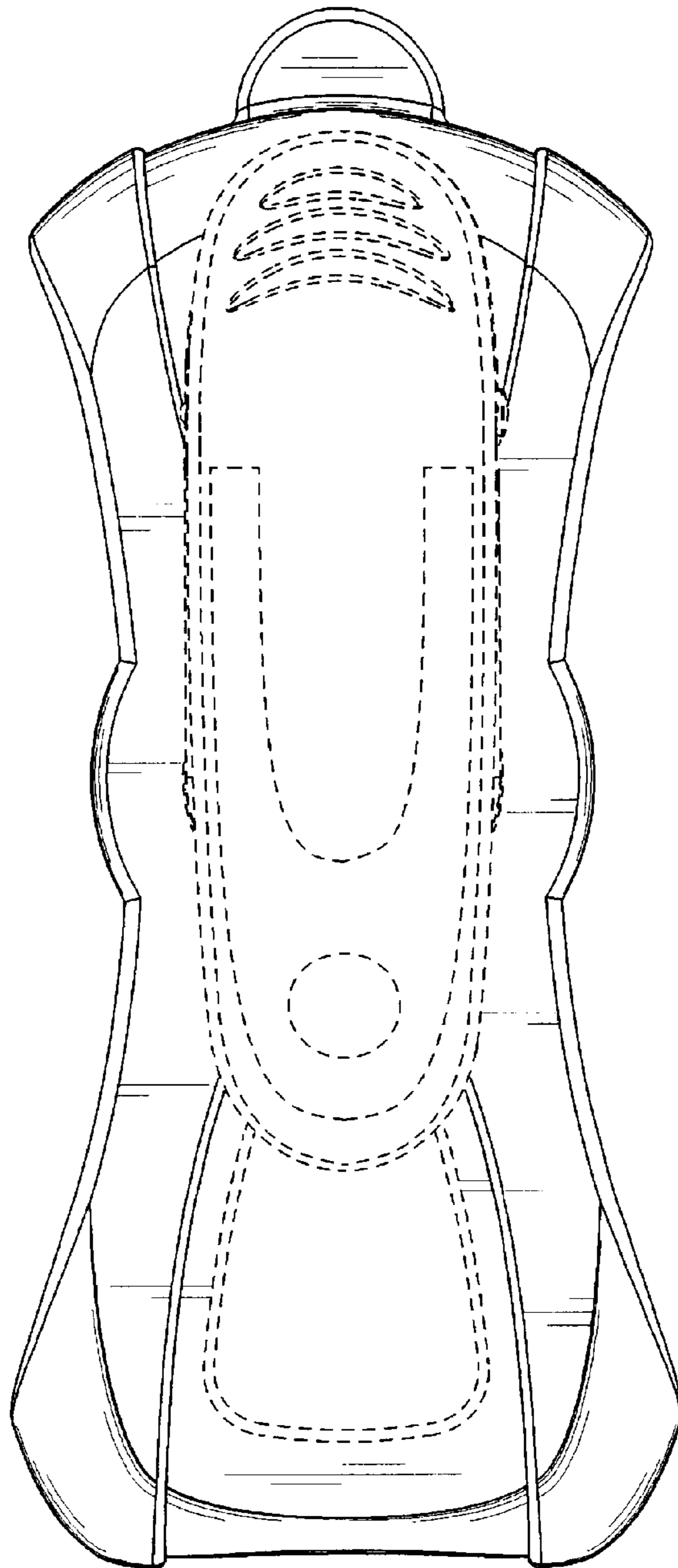

FIG. 3

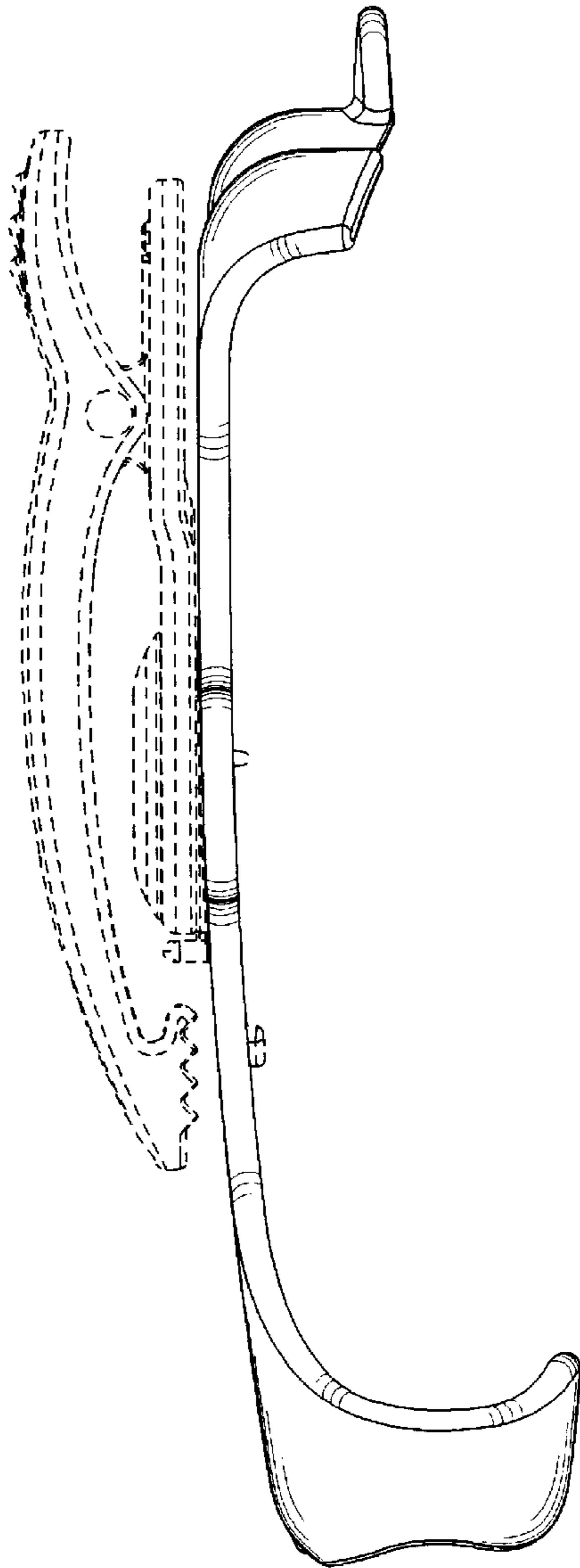

FIG. 4

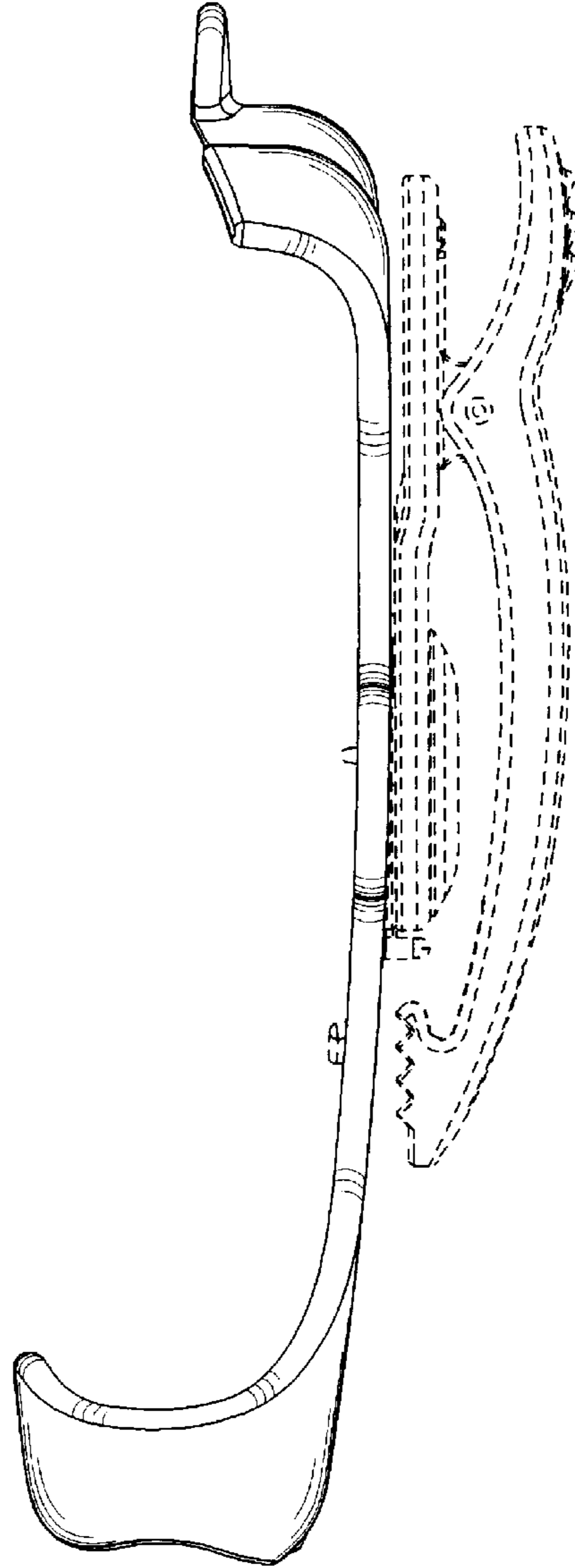

FIG. 5

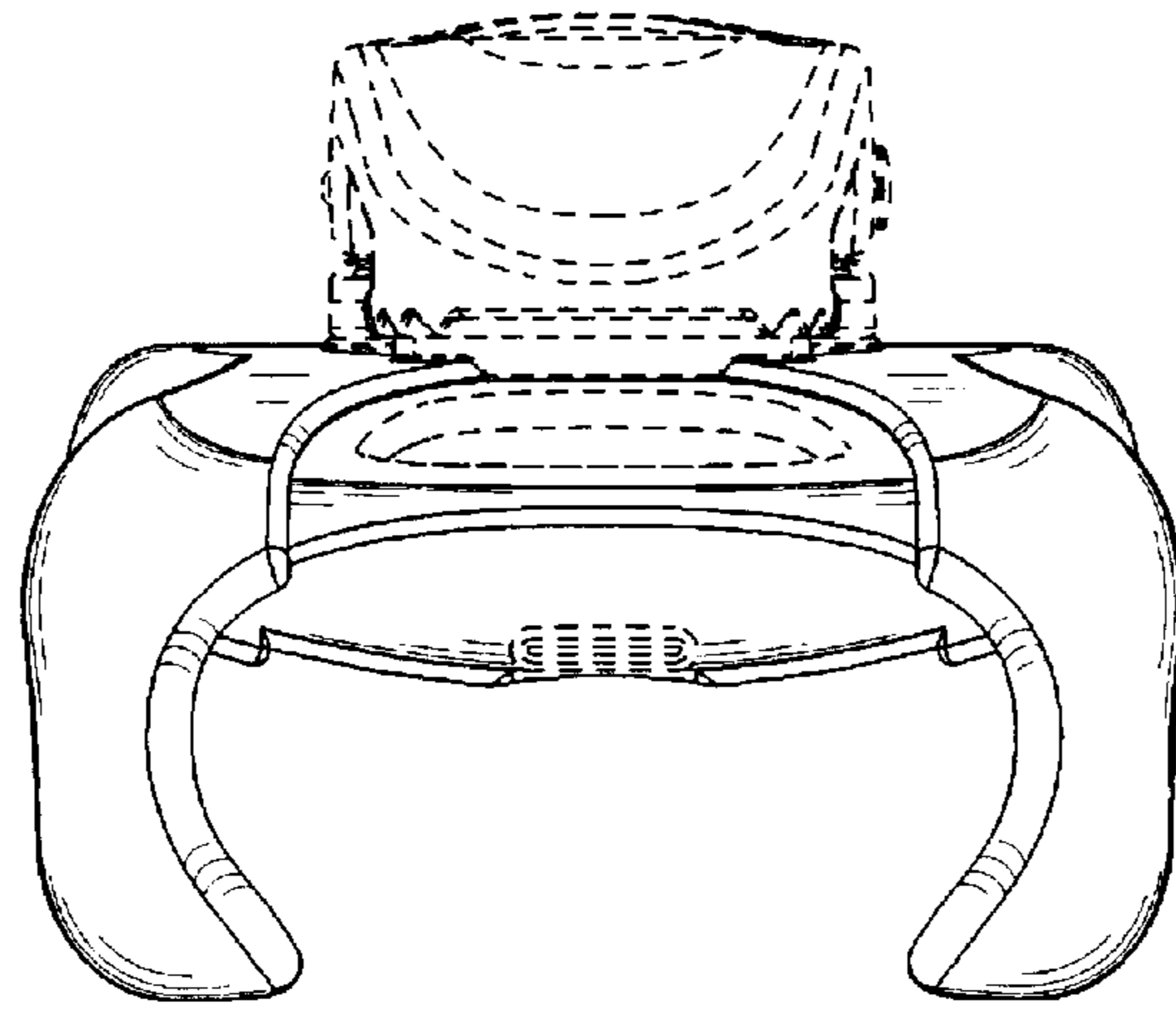

FIG. 6

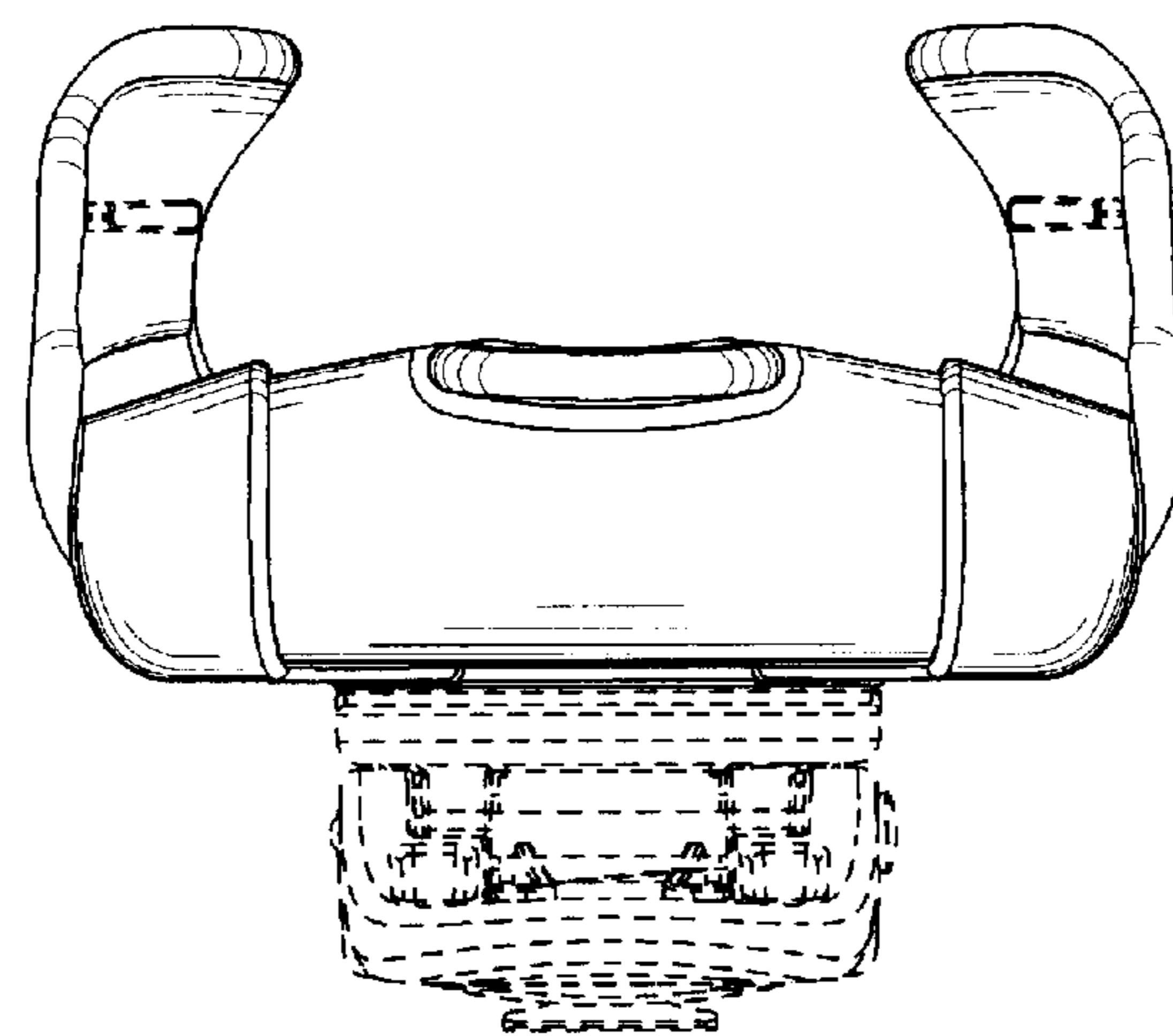

FIG. 7