

US00D504534S

(12) **United States Design Patent**
Osiecki et al.

(10) **Patent No.:** **US D504,534 S**

(45) **Date of Patent:** **** Apr. 26, 2005**

(54) **FLASHLIGHT**

(75) Inventors: **Scott Osiecki**, Skaneateles, NY (US);
Robert Englert, Syracuse, NY (US);
Andrew Schweitzer, Syracuse, NY (US)

(73) Assignee: **Eveready Battery Company, Inc.**, St. Louis, MO (US)

(**) Term: **14 Years**

(21) Appl. No.: **29/212,741**

(22) Filed: **Sep. 8, 2004**

(51) **LOC (7) Cl.** **26-02**

(52) **U.S. Cl.** **D26/49**

(58) **Field of Search** D26/37-50; 362/157,
362/158, 171-174, 183-208

(56) **References Cited**

U.S. PATENT DOCUMENTS

D475,151 S	*	5/2003	Man	D26/49
D482,151 S	*	11/2003	Shiu	D26/49
D493,904 S	*	8/2004	Dalton et al.	D26/49
D494,299 S	*	8/2004	Dalton et al.	D26/49

* cited by examiner

Primary Examiner—Marcus A. Jackson

(74) *Attorney, Agent, or Firm*—Stewart A. Fraser

(57) **CLAIM**

We claim the ornamental design for a flashlight, as shown and described.

DESCRIPTION

FIG. 1 is a right rear view of the flashlight of the present invention, with the broken line showing for illustrative purposes only and forming no part of the claimed design; FIG. 2 is a left front view of the flashlight of the present invention;

FIG. 3 is a top view of the flashlight of the present invention; FIG. 4 is a bottom view of the flashlight of the present invention;

FIG. 5 is a view of the right side of the flashlight of the present invention;

FIG. 6 is a view of the left side of the flashlight of the present invention;

FIG. 7 is a front view of the flashlight of the present invention; and,

FIG. 8 is a rear view of the flashlight of the present invention.

1 Claim, 8 Drawing Sheets

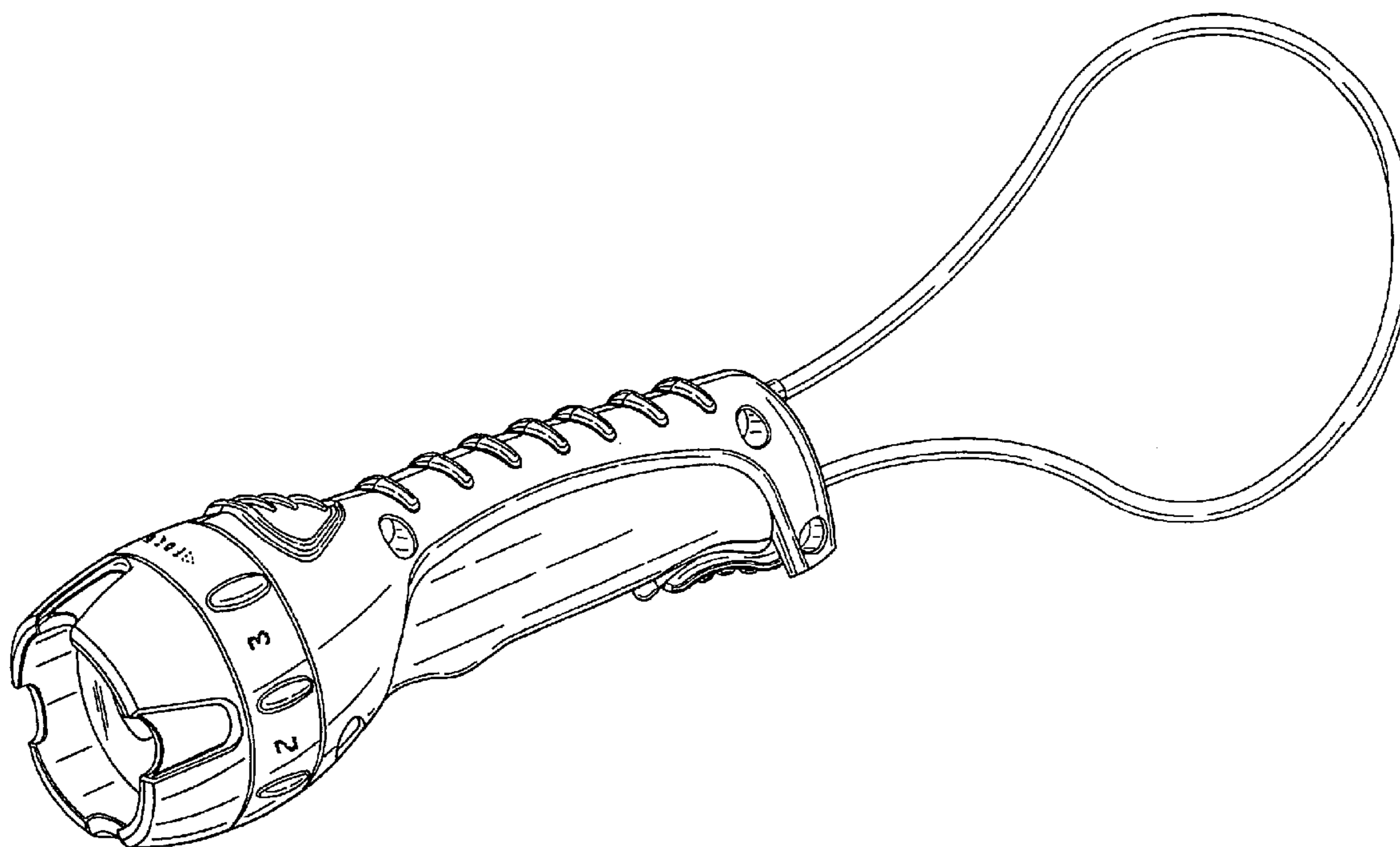

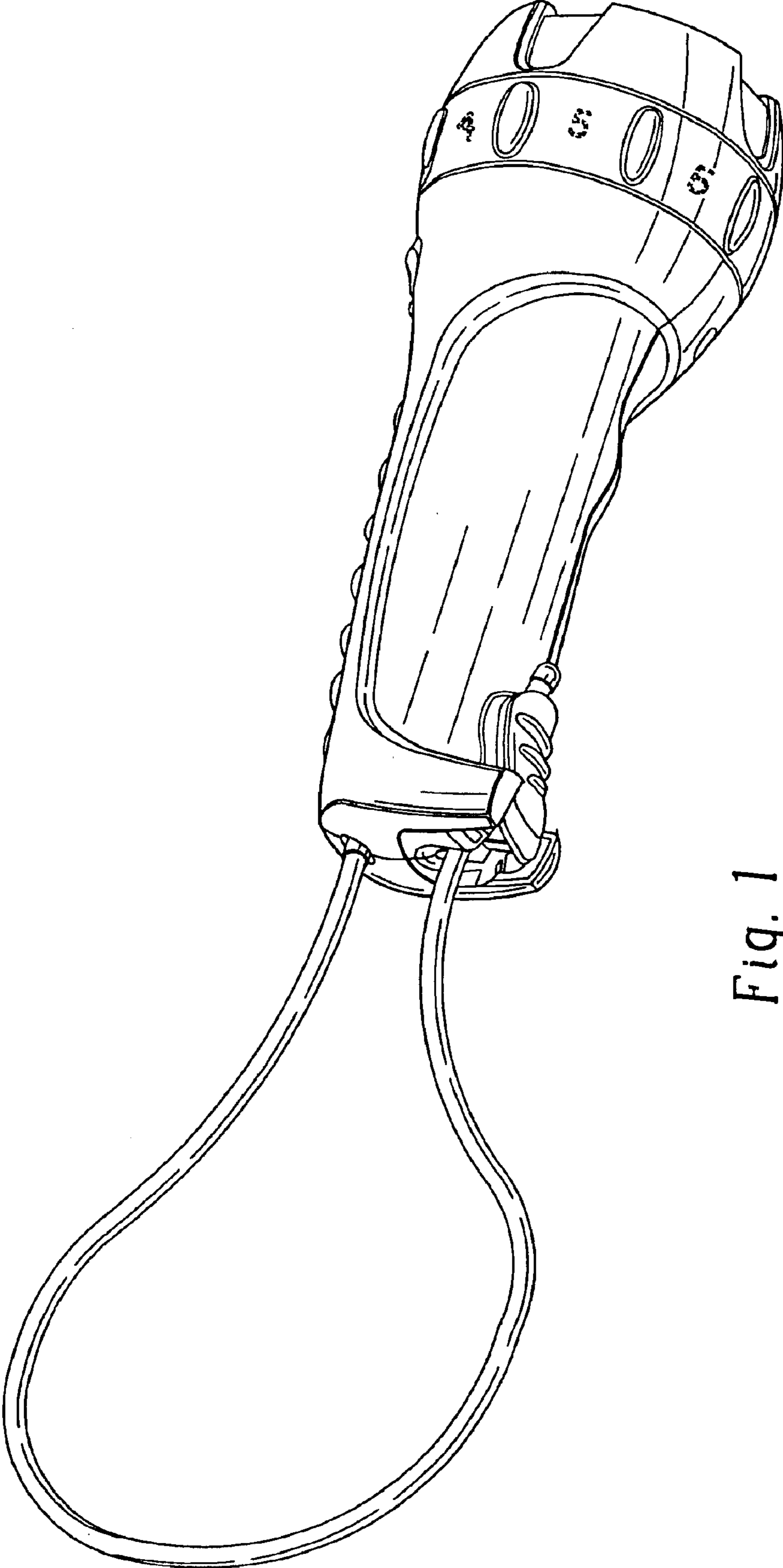

Fig. 1

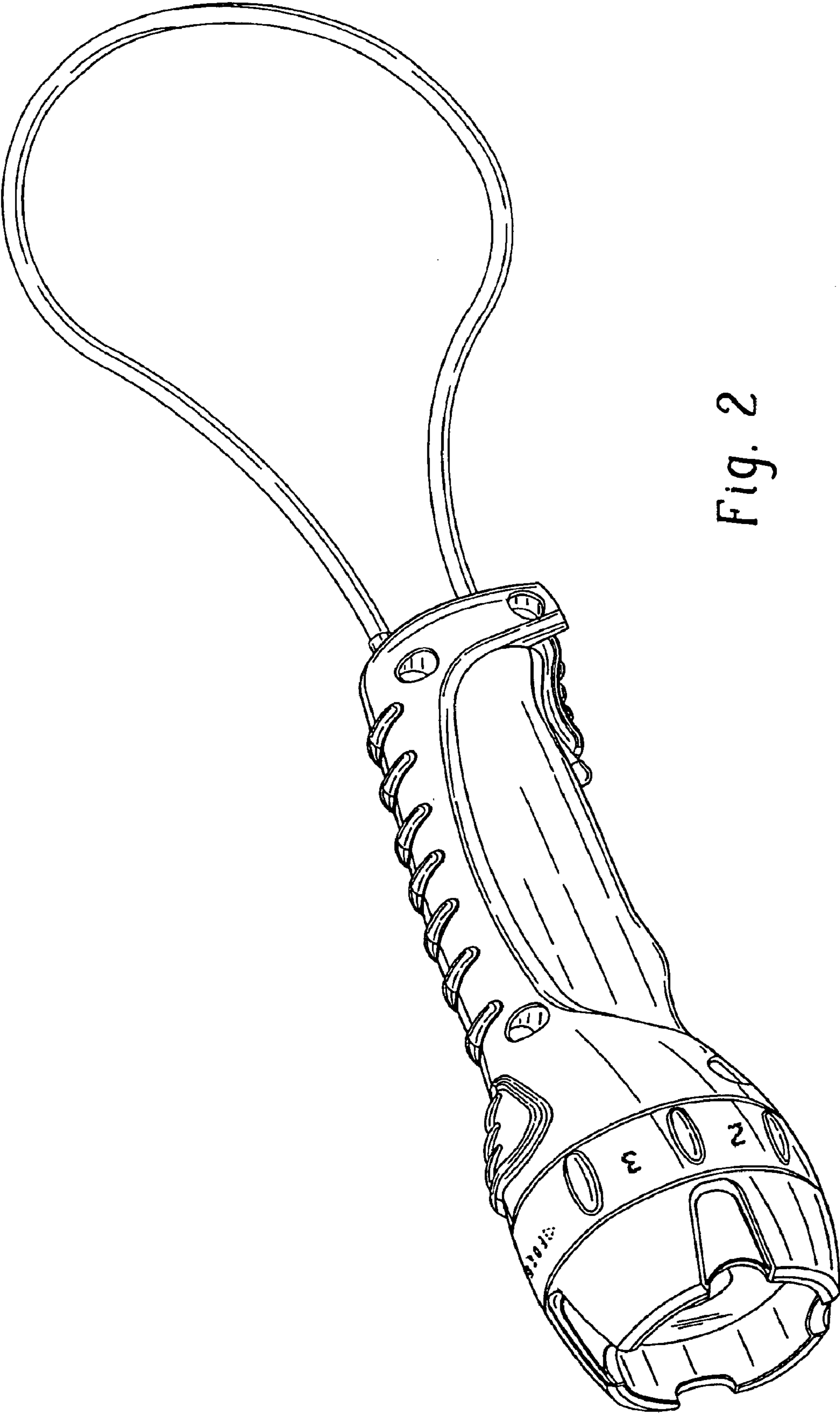

Fig. 2

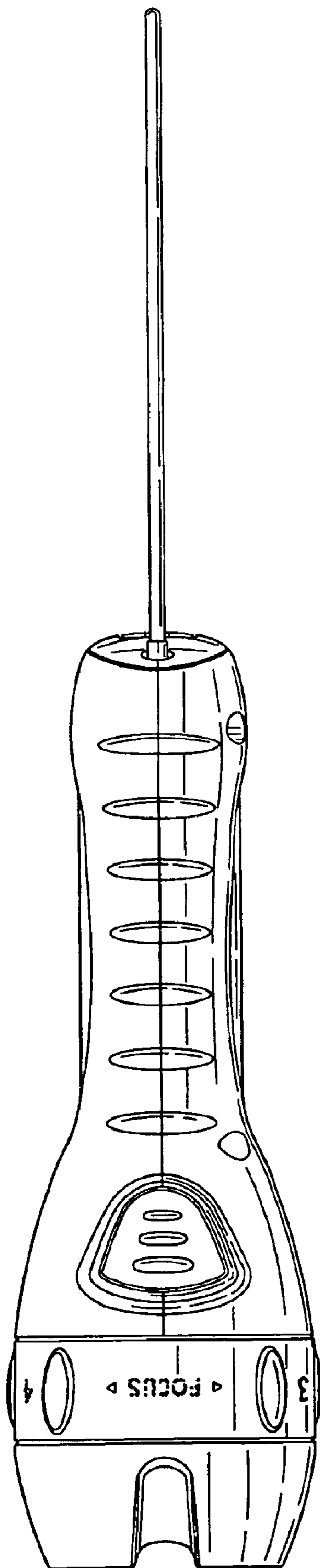

Fig. 3

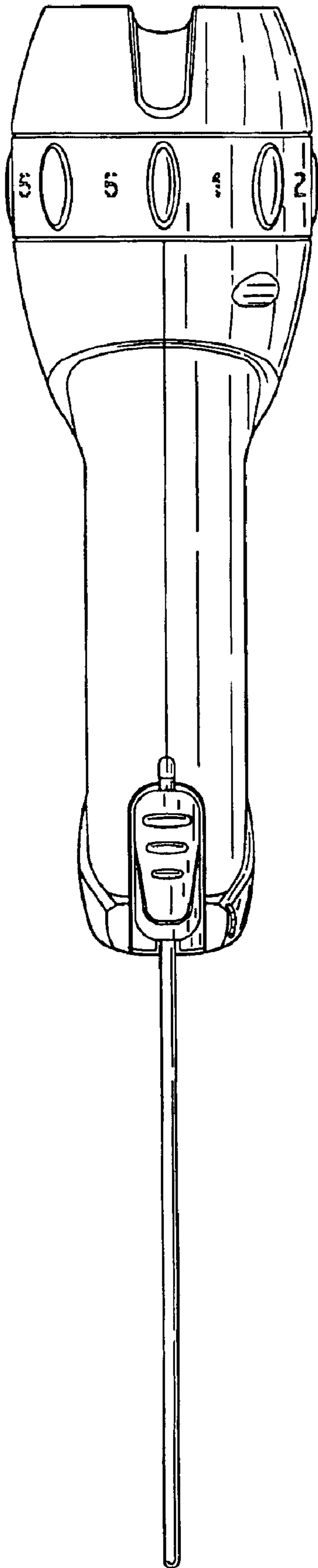

Fig. 4

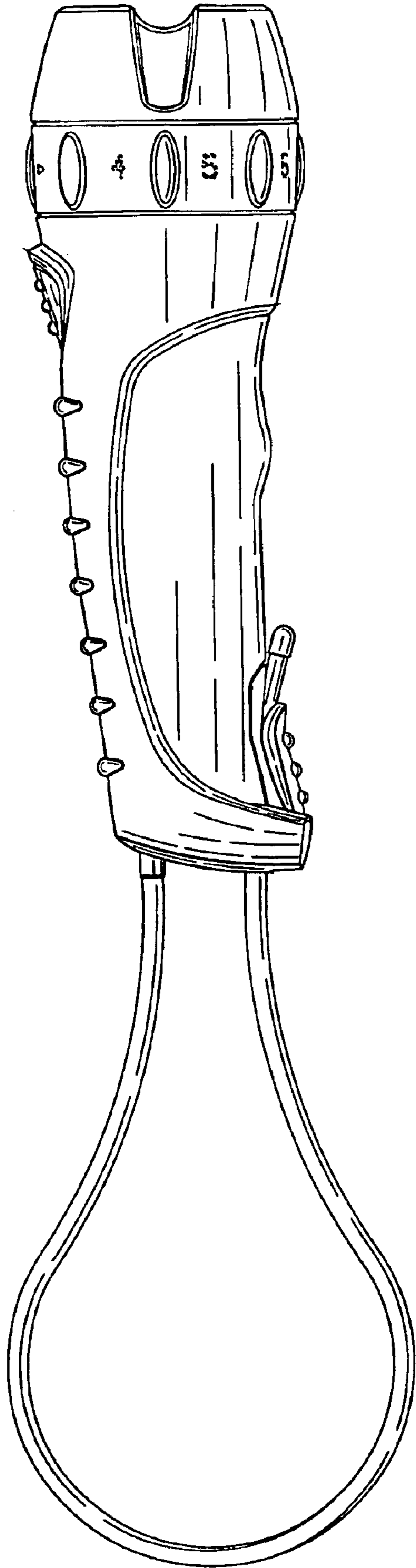

Fig. 5

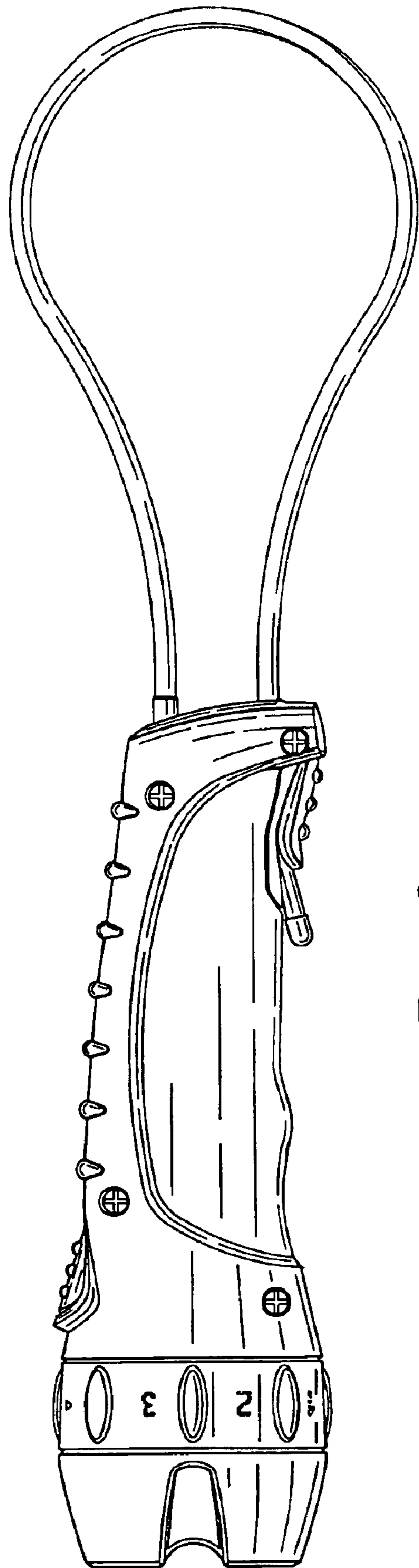

Fig. 6

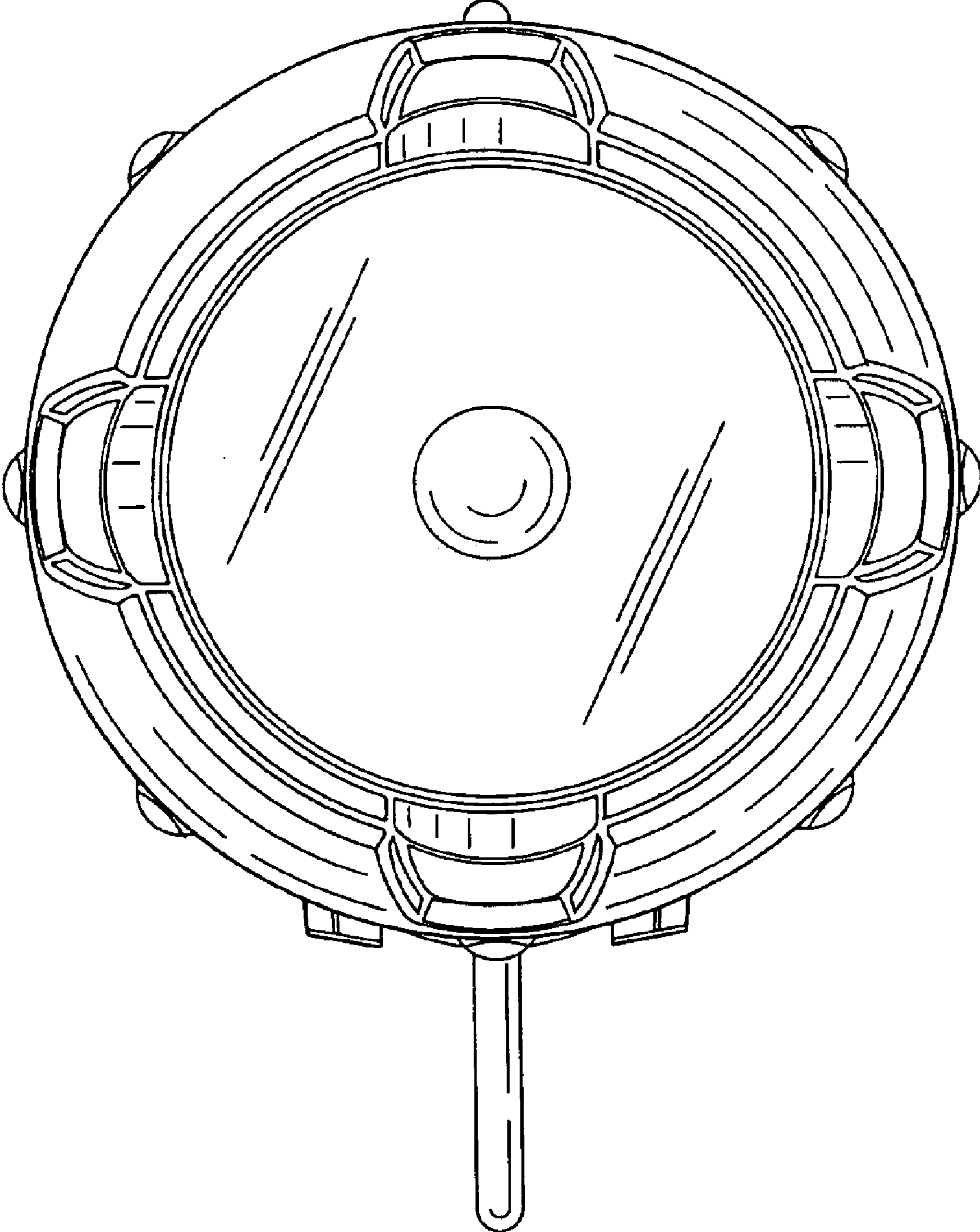

Fig. 7

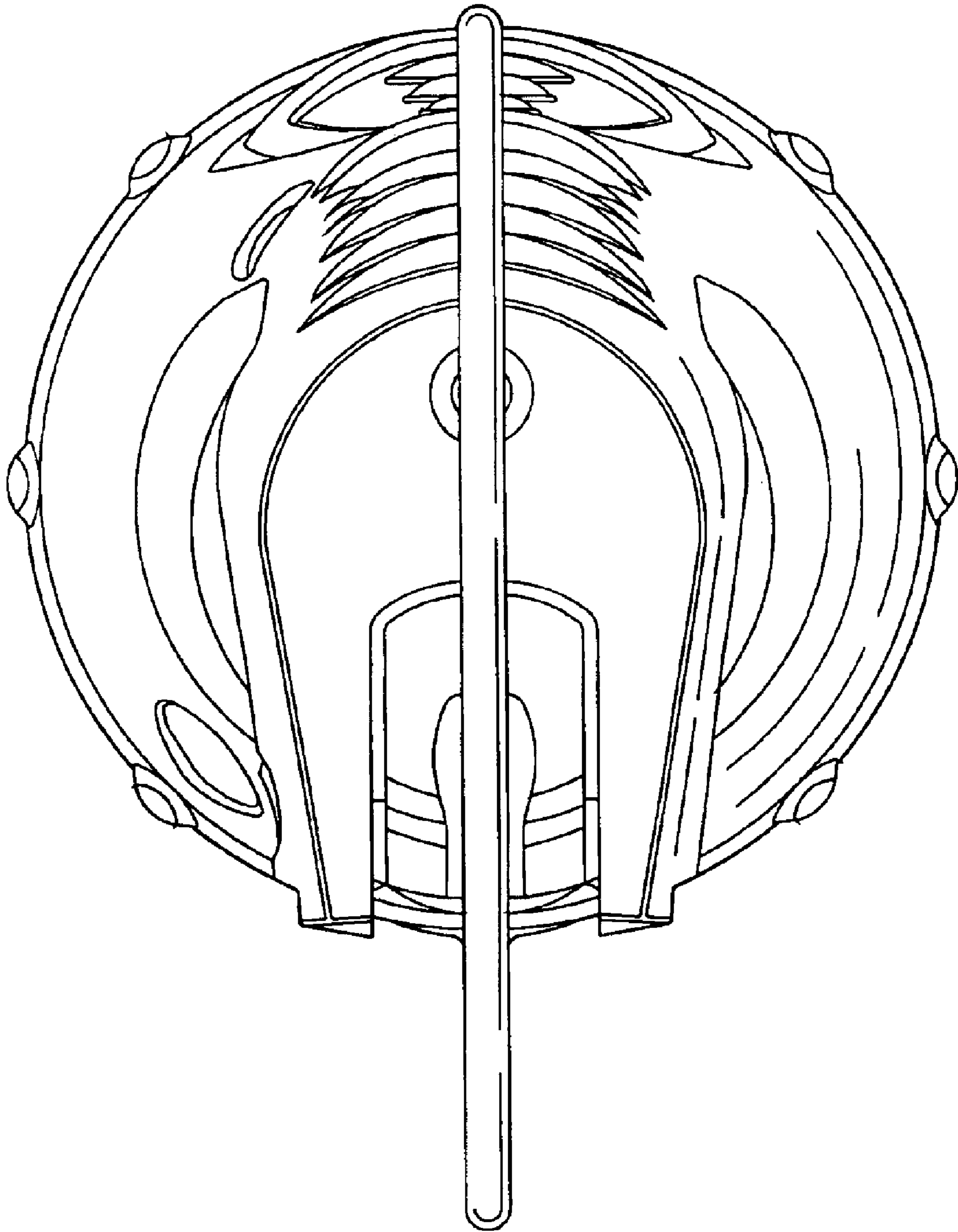

Fig. 8