

US00D504489S

(12) **United States Design Patent**  
**Cerovic**

(10) **Patent No.:** **US D504,489 S**

(45) **Date of Patent:** **\*\* Apr. 26, 2005**

(54) **GUN**

(75) **Inventor:** **Milan Cerovic**, Scottsdale, AZ (US)

(73) **Assignee:** **Taser International, Inc.**, Scottsdale, AZ (US)

(\*\*) **Term:** **14 Years**

(21) **Appl. No.:** **29/206,454**

(22) **Filed:** **May 27, 2004**

(51) **LOC (7) Cl.** ..... **22-01**

(52) **U.S. Cl.** ..... **D22/104**; D21/574

(58) **Field of Search** ..... D22/100, 104,  
D22/105, 108, 199; D21/567, 570, 573,  
574, 575; 89/148, 196; 362/110, 113; 124/78,  
6, 16, 27, 49; 42/7, 54, 71.02, 65, 75

(56) **References Cited**

**U.S. PATENT DOCUMENTS**

- 5,050,480 A \* 9/1991 Knight et al. .... 89/147
- 5,522,167 A \* 6/1996 Teetzel ..... 42/117
- D445,846 S \* 7/2001 Hornsby et al. .... D21/574
- D449,354 S \* 10/2001 Hornsby et al. .... D21/574
- D449,659 S \* 10/2001 Hornsby et al. .... D21/574
- 6,341,442 B1 \* 1/2002 Szabo et al. .... 42/70.08
- D454,166 S \* 3/2002 Hornsby et al. .... D21/574

- D454,926 S \* 3/2002 Hornsby et al. .... D21/574
- D458,652 S \* 6/2002 Chan ..... D21/574
- D458,975 S \* 6/2002 Hornsby et al. .... D21/574
- 6,415,702 B1 \* 7/2002 Szabo et al. .... 89/148
- 6,718,680 B2 \* 4/2004 Roca et al. .... 42/70.08

\* cited by examiner

*Primary Examiner*—Louis S. Zarfaz

*Assistant Examiner*—Melanie Levy

(74) *Attorney, Agent, or Firm*—William R. Bachand

(57) **CLAIM**

The ornamental design for a gun, as shown and described.

**DESCRIPTION**

FIG. 1 is a perspective view of a gun, showing novel design;  
 FIG. 2 is a left side view of the gun of FIG. 1;  
 FIG. 3 is a right side view of the gun of FIG. 1;  
 FIG. 4 is a top view of the gun of FIG. 1;  
 FIG. 5 is a bottom view of the gun of FIG. 1;  
 FIG. 6 is a front view of the gun of FIG. 1; and,  
 FIG. 7 is a rear view of the gun of FIG. 1.

The dashed lines in the drawing show environment and form no part of the claimed design.

The broken lines shown in FIGS. 1–7 are for illustrative purposes only and form no part of the claimed design.

**1 Claim, 4 Drawing Sheets**

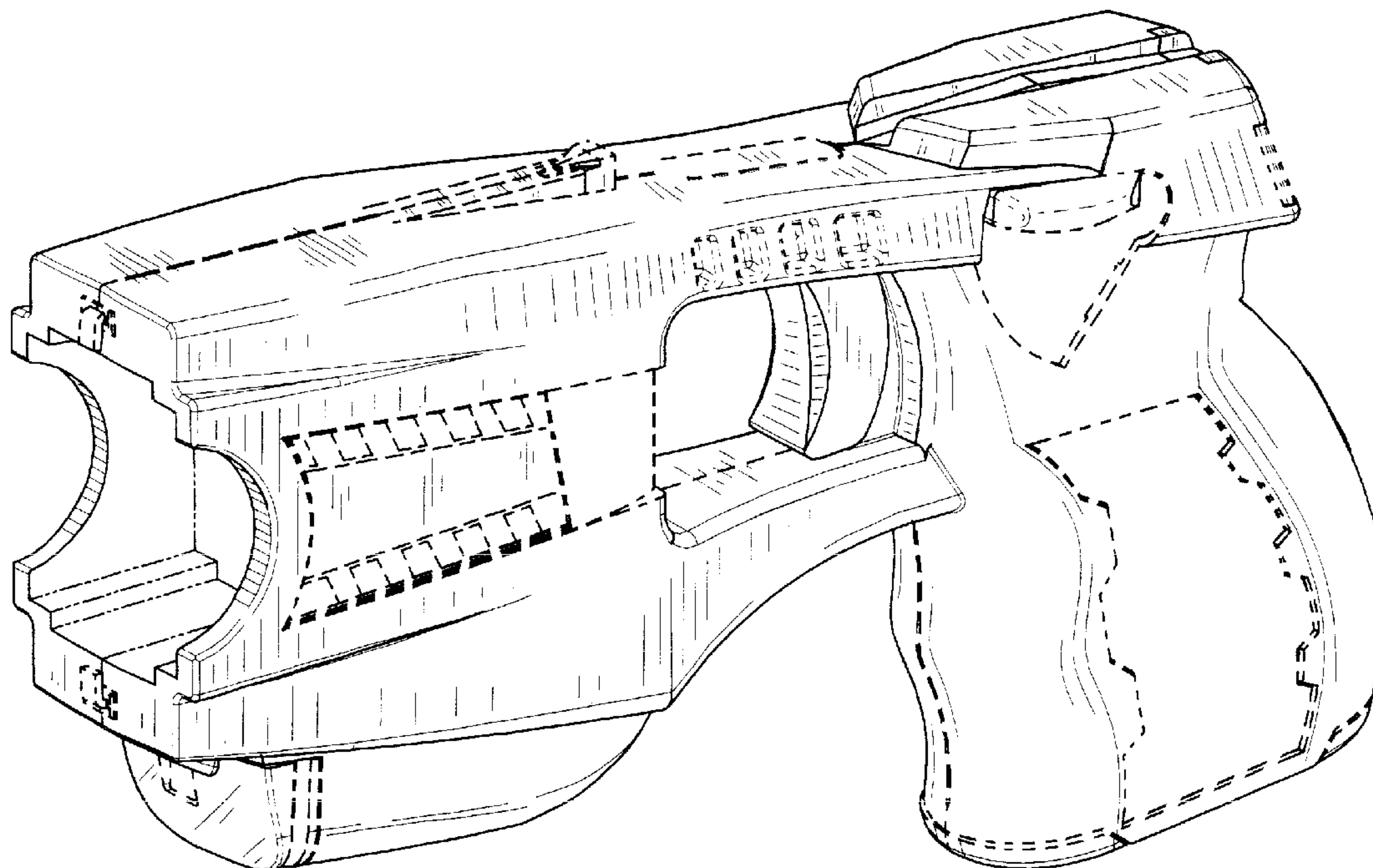

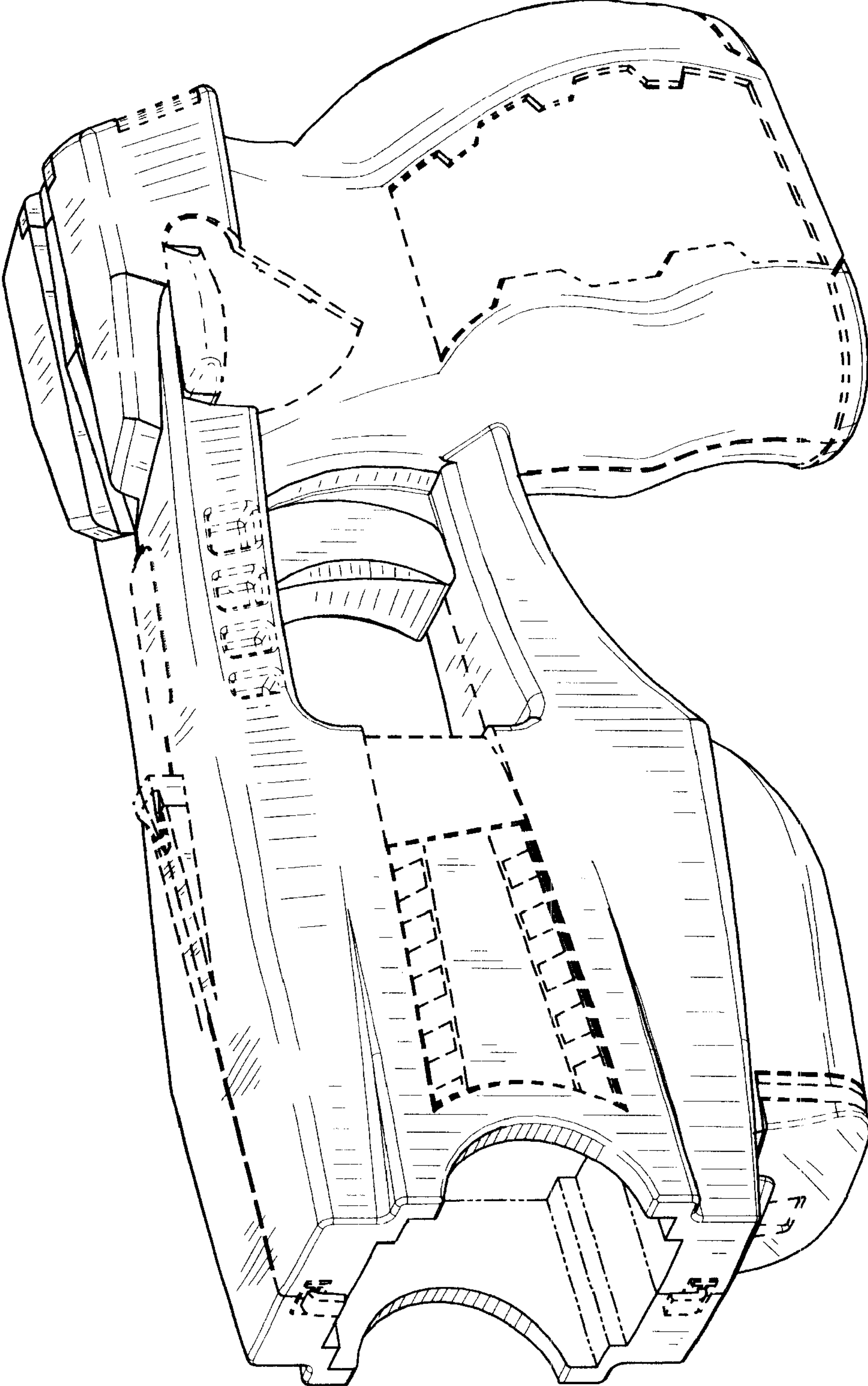

FIG. 1

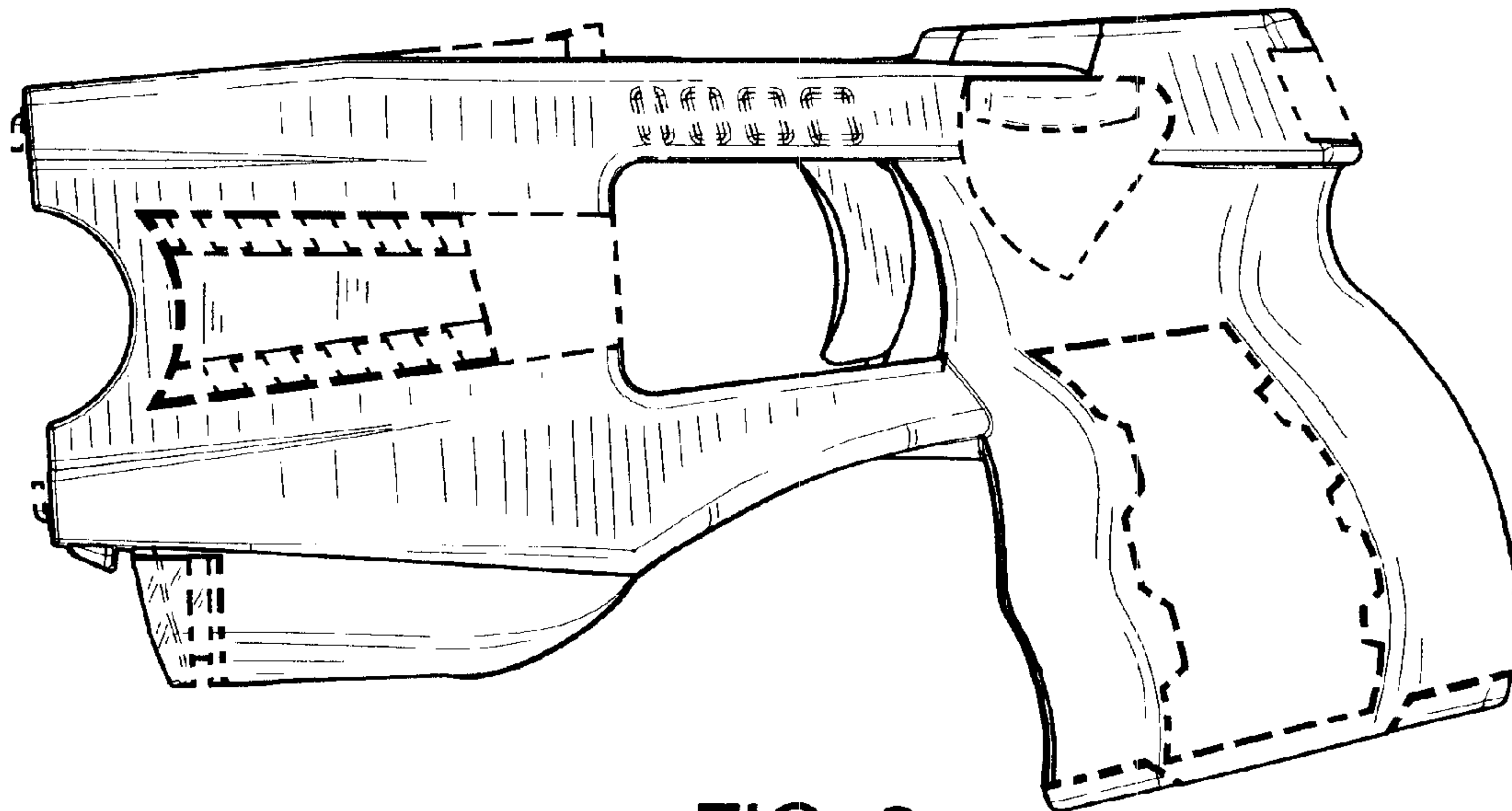

FIG. 2

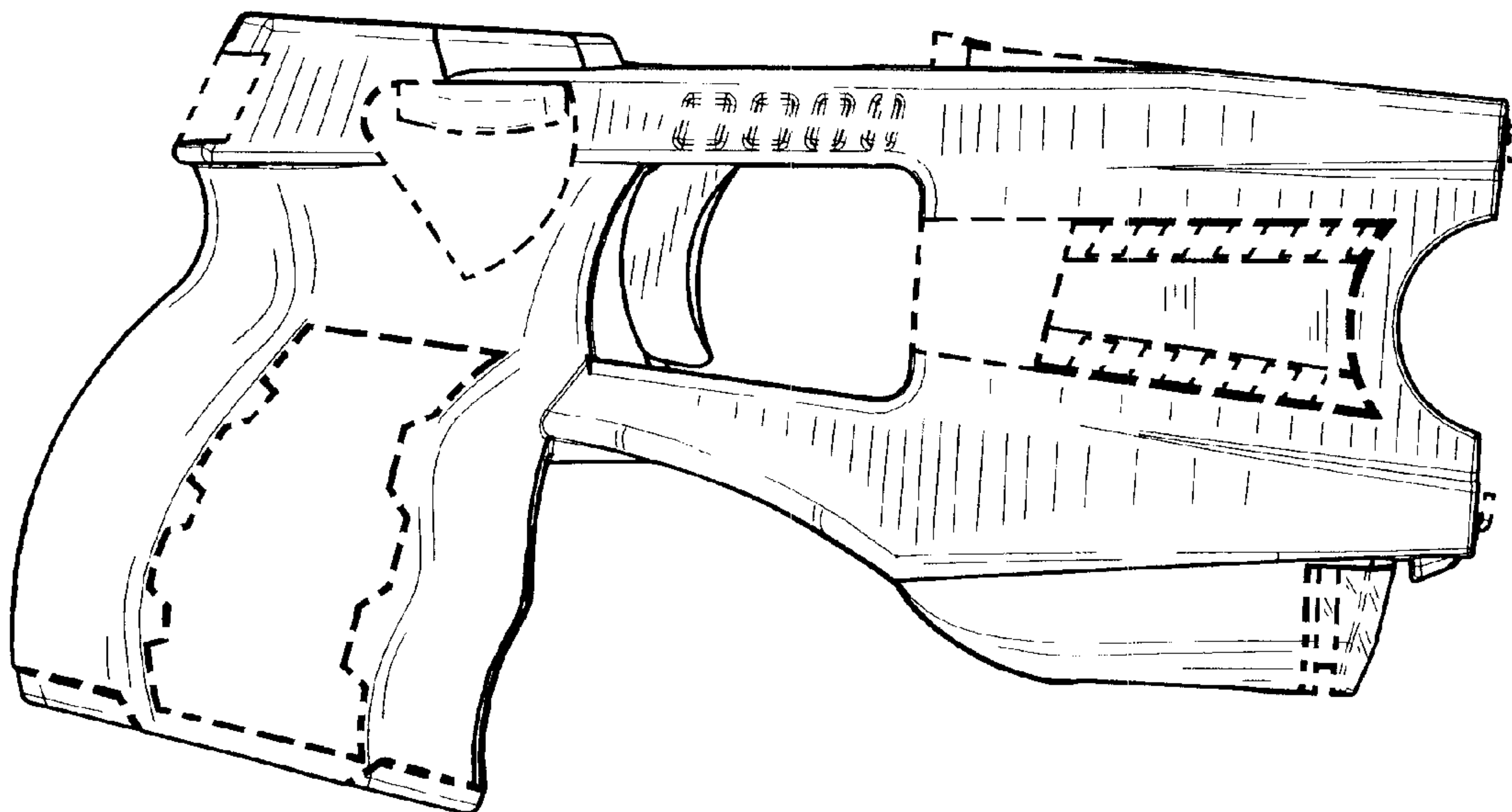

FIG. 3

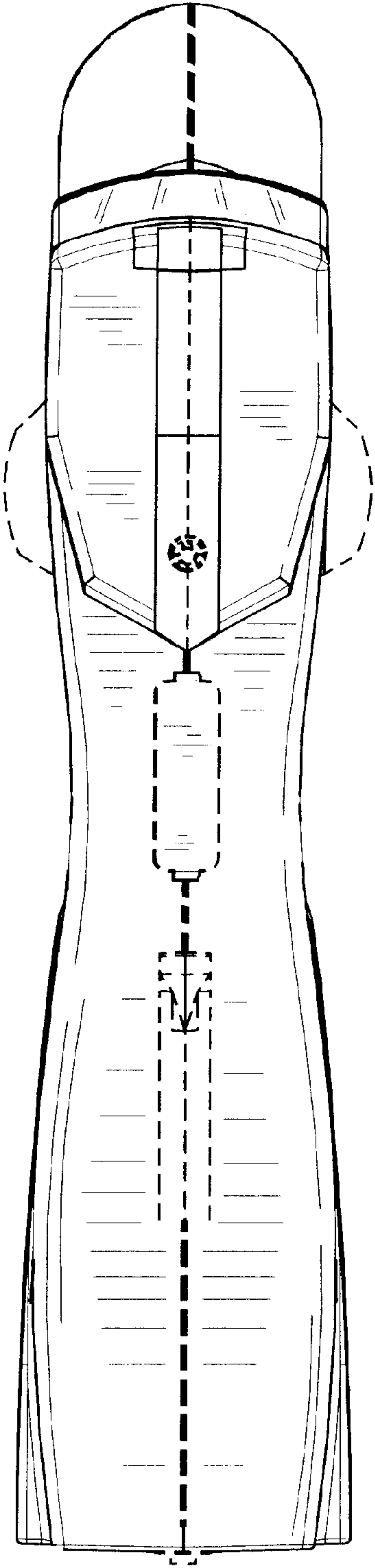

FIG. 4

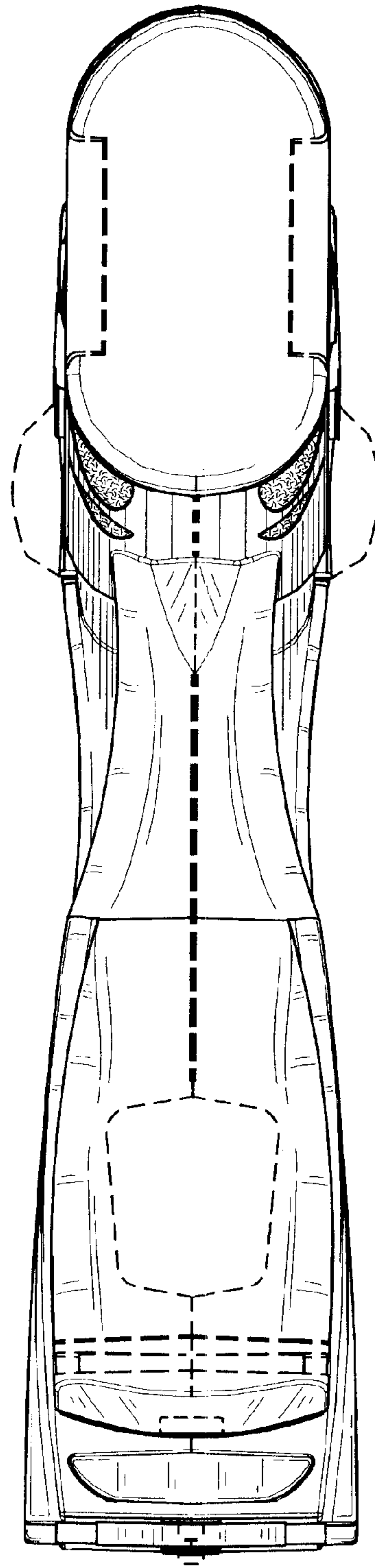

FIG. 5



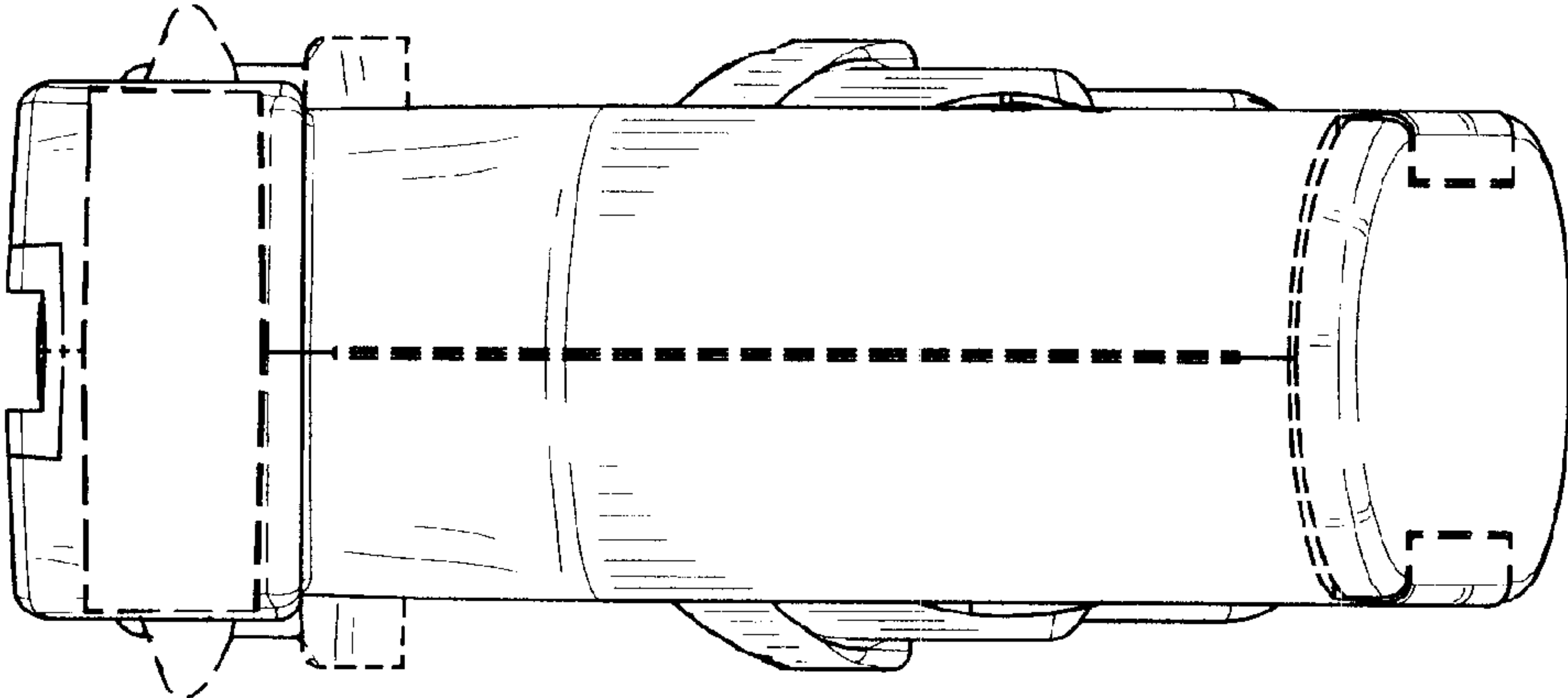

FIG. 7

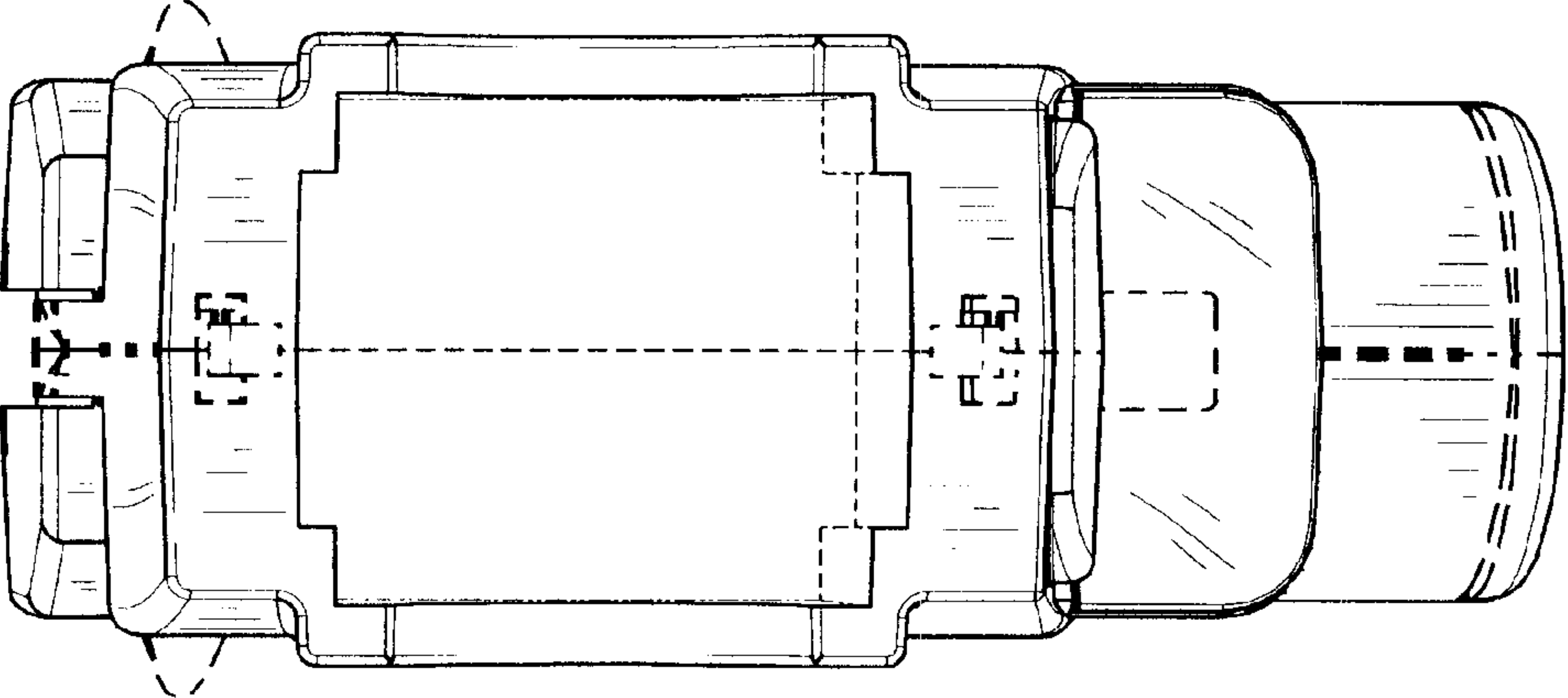

FIG. 6