

US00D504478S

(12) **United States Design Patent**  
**Burrows**

(10) **Patent No.:** **US D504,478 S**  
(45) **Date of Patent:** **\*\* Apr. 26, 2005**

(54) **WOOD TYPE HEAD FOR A GOLF CLUB**

(75) Inventor: **Bruce D. Burrows**, Santa Clarita, CA  
(US)

(73) Assignee: **Burrows Golf, LLC**, Valencia, CA  
(US)

(\*\*) Term: **14 Years**

(21) Appl. No.: **29/191,061**

(22) Filed: **Sep. 30, 2003**

(51) **LOC (7) Cl.** ..... **21-02**

(52) **U.S. Cl.** ..... **D21/752**

(58) **Field of Search** ..... D21/733, 752;  
473/324-331, 343, 344, 345, 346

(56) **References Cited**

**U.S. PATENT DOCUMENTS**

1,541,128	A	*	6/1925	Dunn	.....	473/345
1,588,617	A	*	6/1926	Rose	.....	473/343
3,374,027	A	*	3/1968	Jacobs	.....	473/286
4,511,145	A	*	4/1985	Schmidt	.....	473/346
D354,103	S	*	1/1995	Allen	.....	D21/752
D356,356	S	*	3/1995	Jacobs	.....	D21/744
D364,666	S	*	11/1995	Nagy	.....	D21/743
D366,919	S	*	2/1996	Jacobs	.....	D21/745
D385,003	S		10/1997	Burrows		
D390,294	S		2/1998	Burrows		
D390,295	S		2/1998	Burrows		
D392,354	S		3/1998	Burrows		
D397,749	S		9/1998	Burrows		

D401,299	S		11/1998	Burrows		
5,851,159	A		12/1998	Burrows		
D413,642	S		9/1999	Burrows		
D413,953	S		9/1999	Burrows		
D422,659	S	*	4/2000	Mertens	.....	D21/745
D437,903	S	*	2/2001	Cope	.....	D21/752
6,422,951	B1		7/2002	Burrows		
D465,251	S	*	11/2002	Wood et al.	.....	D21/752

\* cited by examiner

*Primary Examiner*—Mitchell Siegel

(74) *Attorney, Agent, or Firm*—Kelly Lowry & Kelly, LLP

(57) **CLAIM**

The ornamental design for a wood type head for a golf club, as shown and described.

**DESCRIPTION**

FIG. 1 is a perspective view showing the bottom, front and toe end sides of a wood-type for a golf club embodying the new design;

FIG. 2 is a front elevational view thereof;

FIG. 3 is a toe end elevational view thereof;

FIG. 4 is a p heel end elevational view thereof;

FIG. 5 is a rear elevational view thereof;

FIG. 6 is a top plan view thereof; and,

FIG. 7 is a bottom plan view thereof.

The broken line showings of a fragmented golf club shaft and a faceplate groove pattern are for illustrative purposes only and form no part of the claimed design.

**1 Claim, 4 Drawing Sheets**

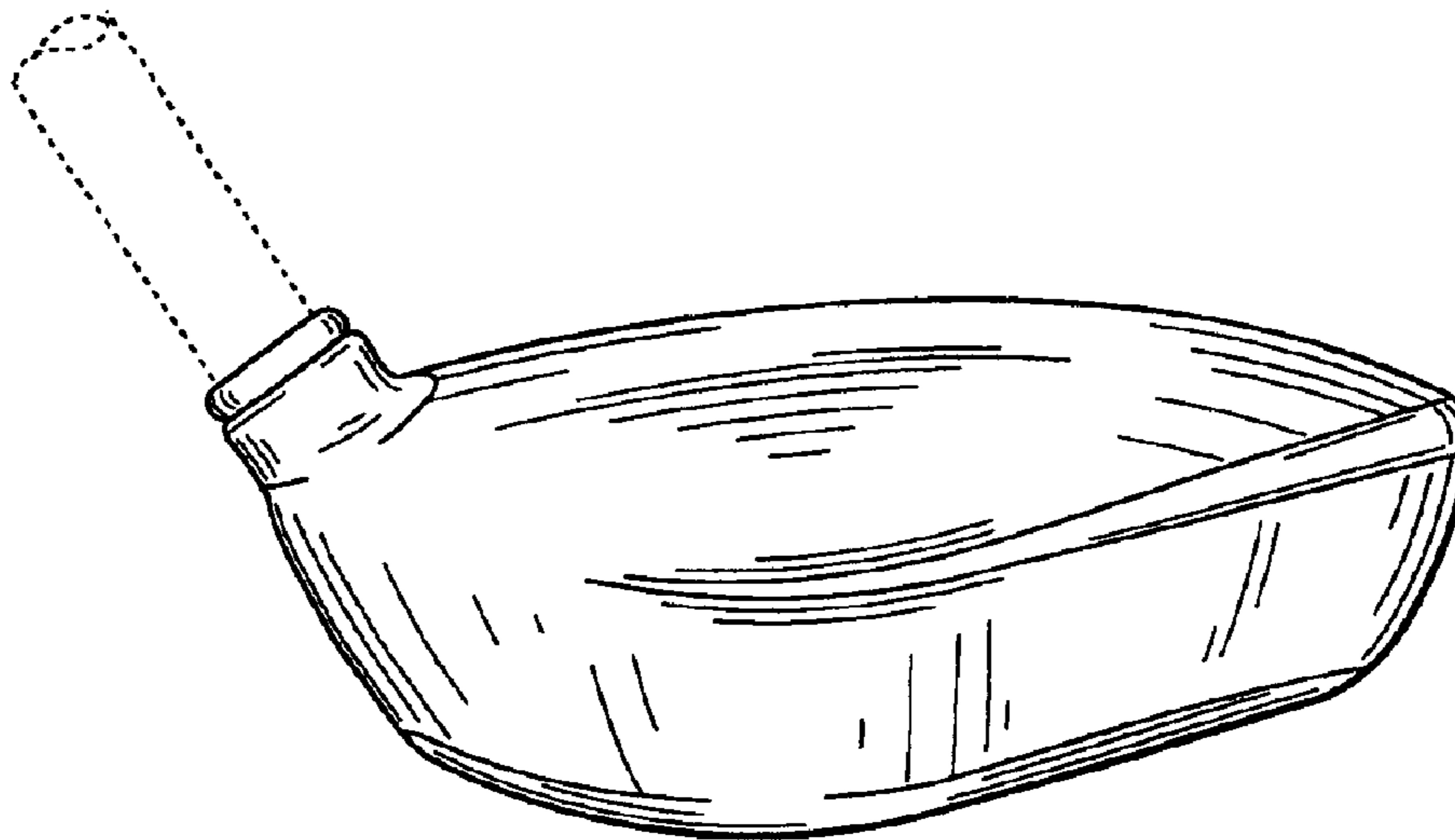

FIG. 1

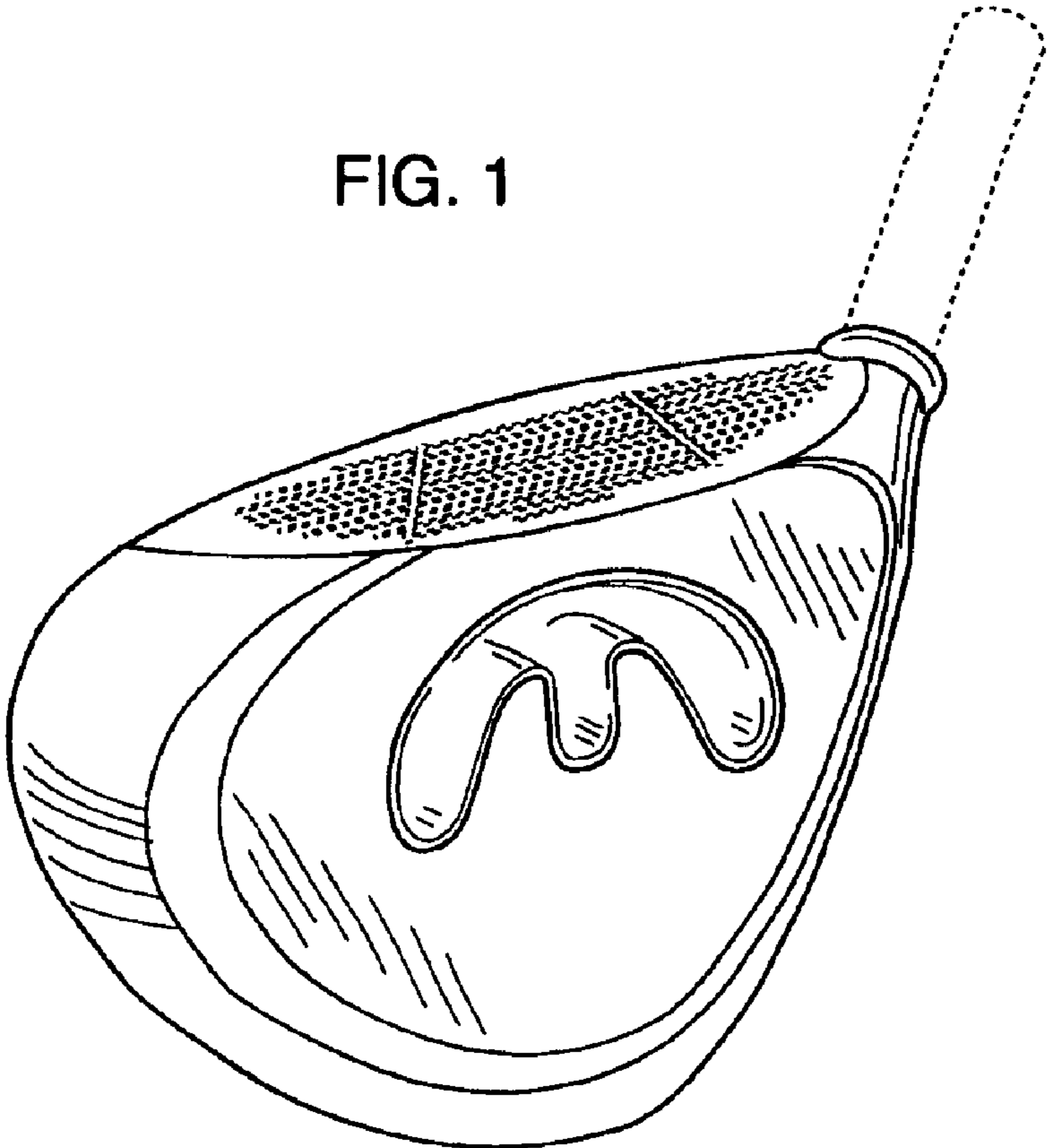

FIG. 2

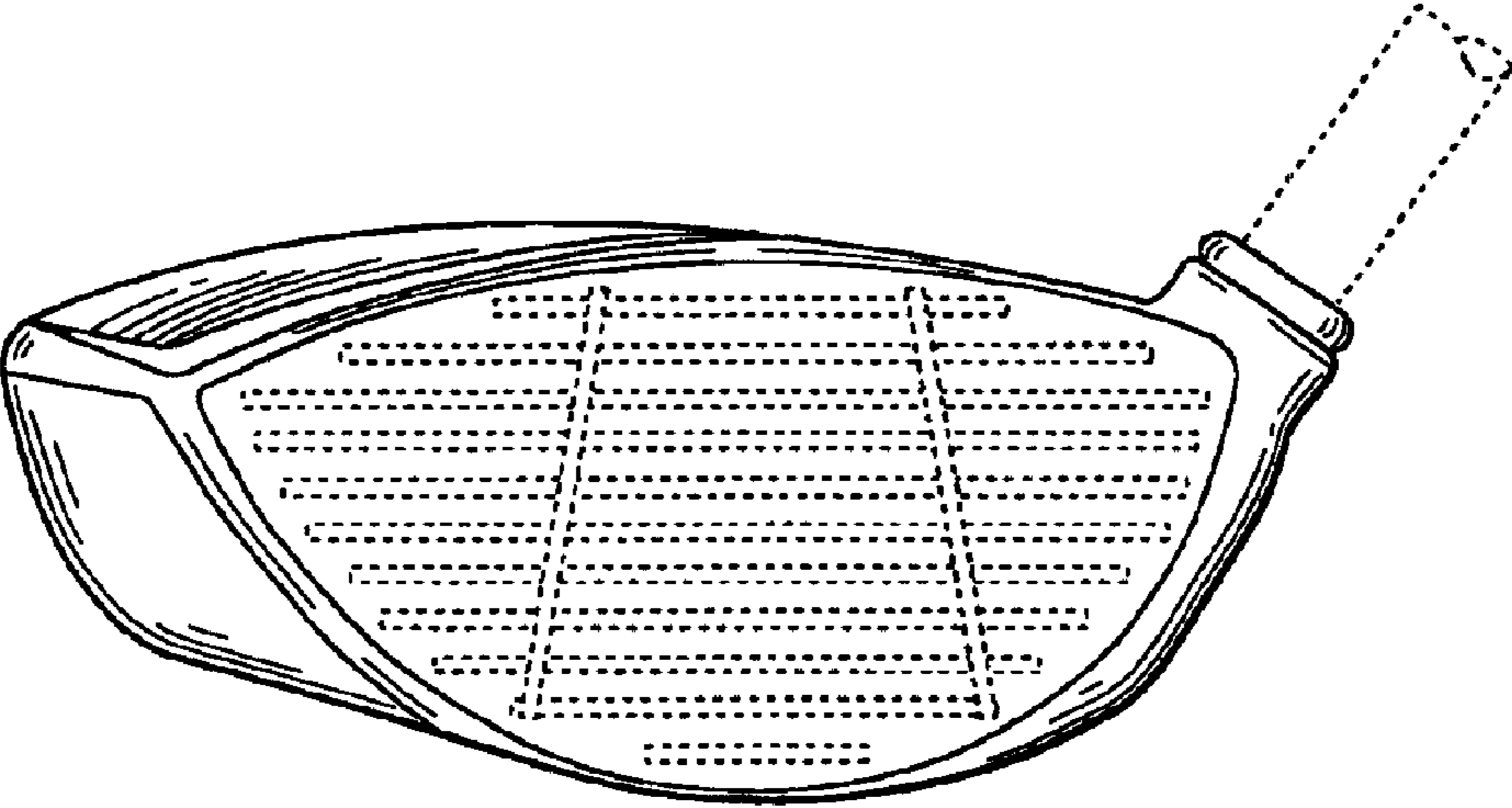

FIG. 3

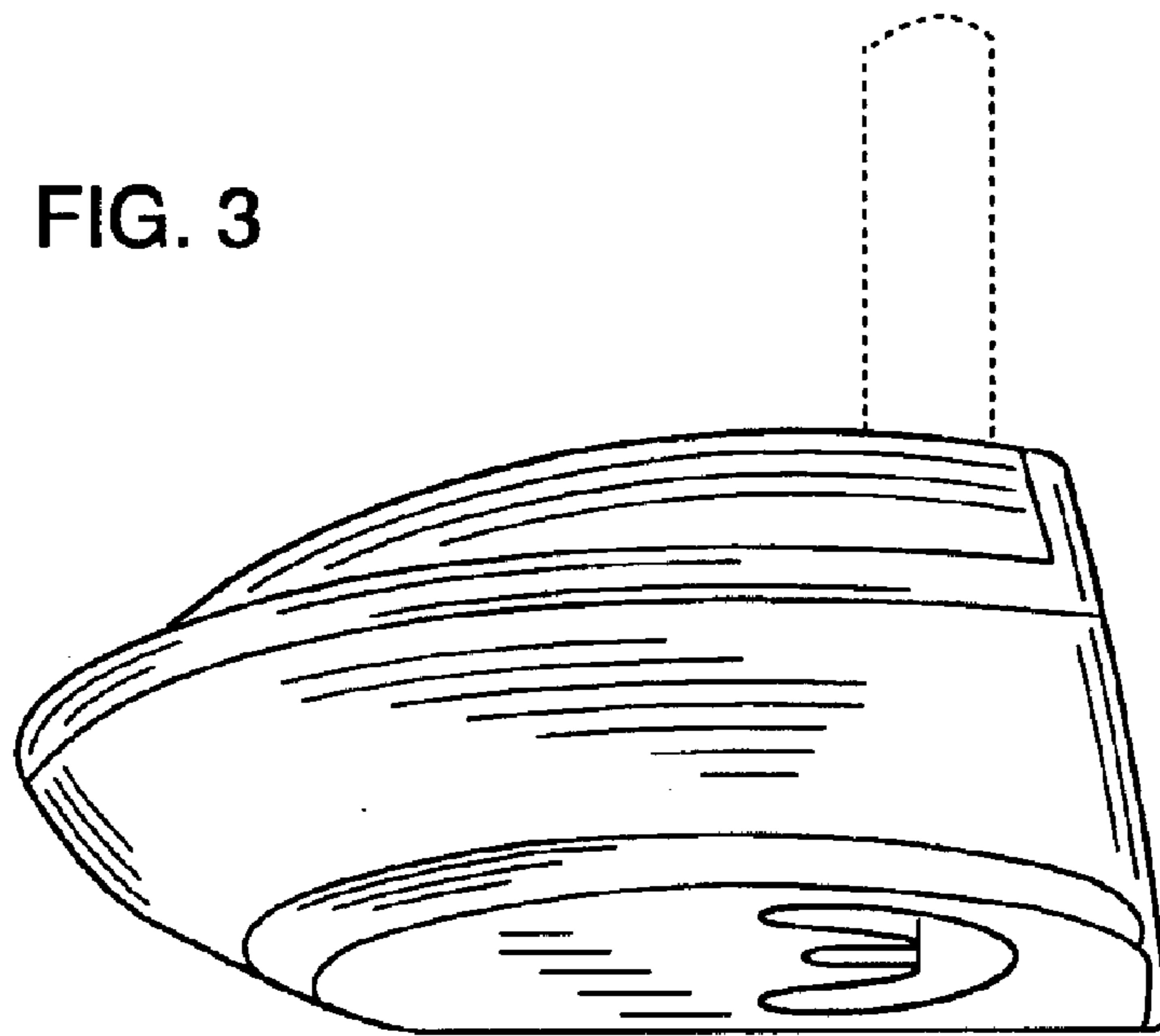
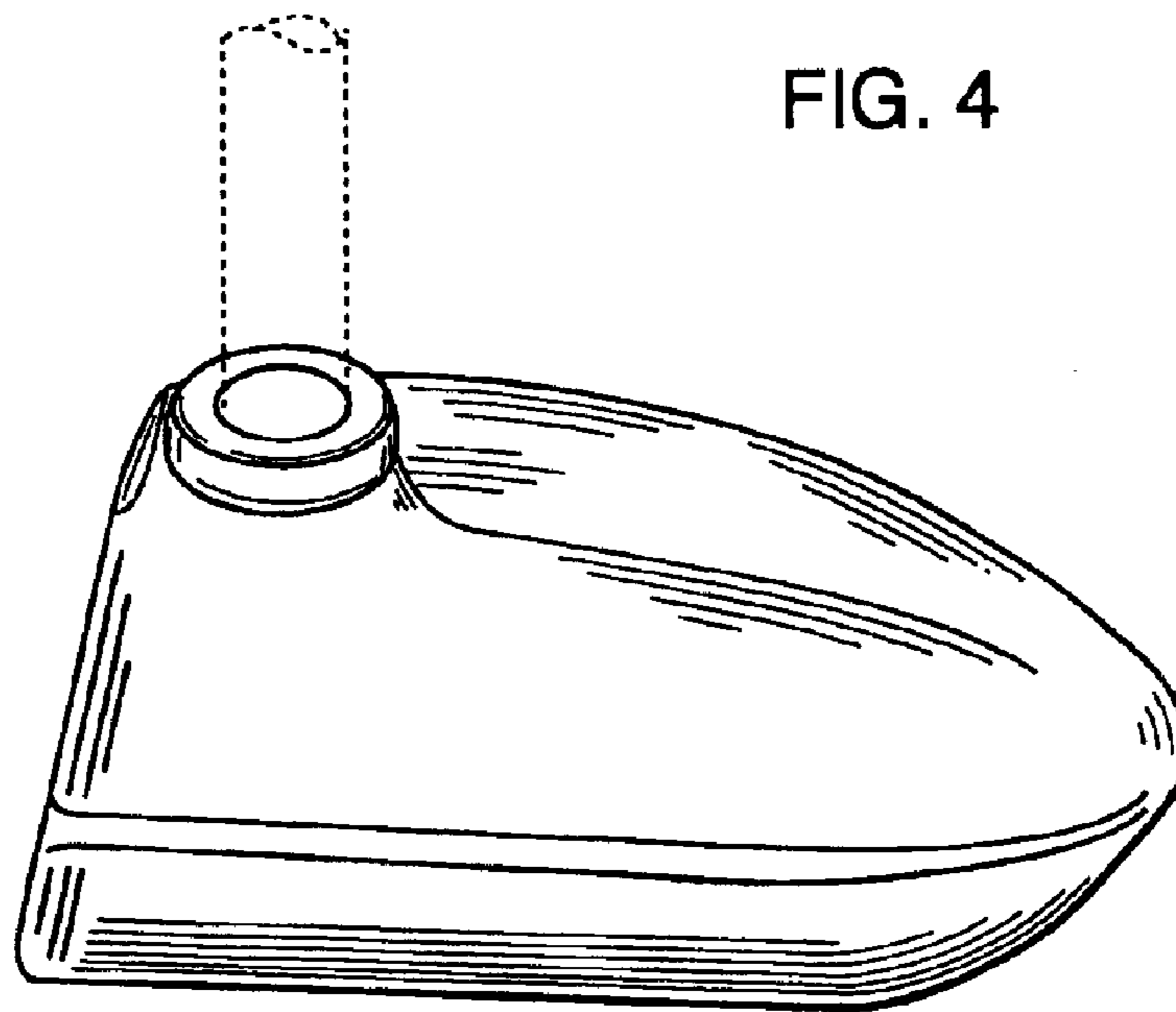

FIG. 4



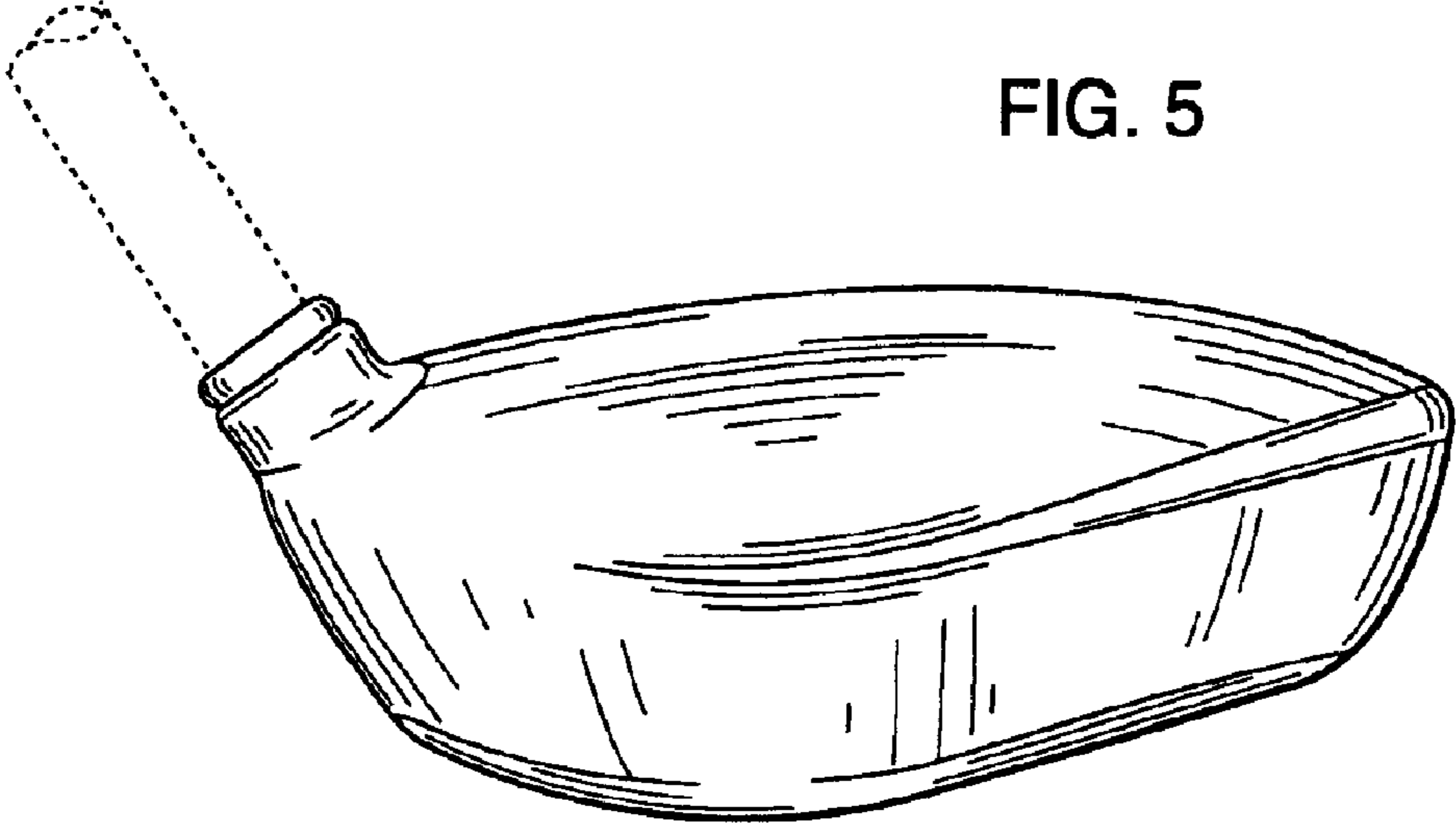

FIG. 5

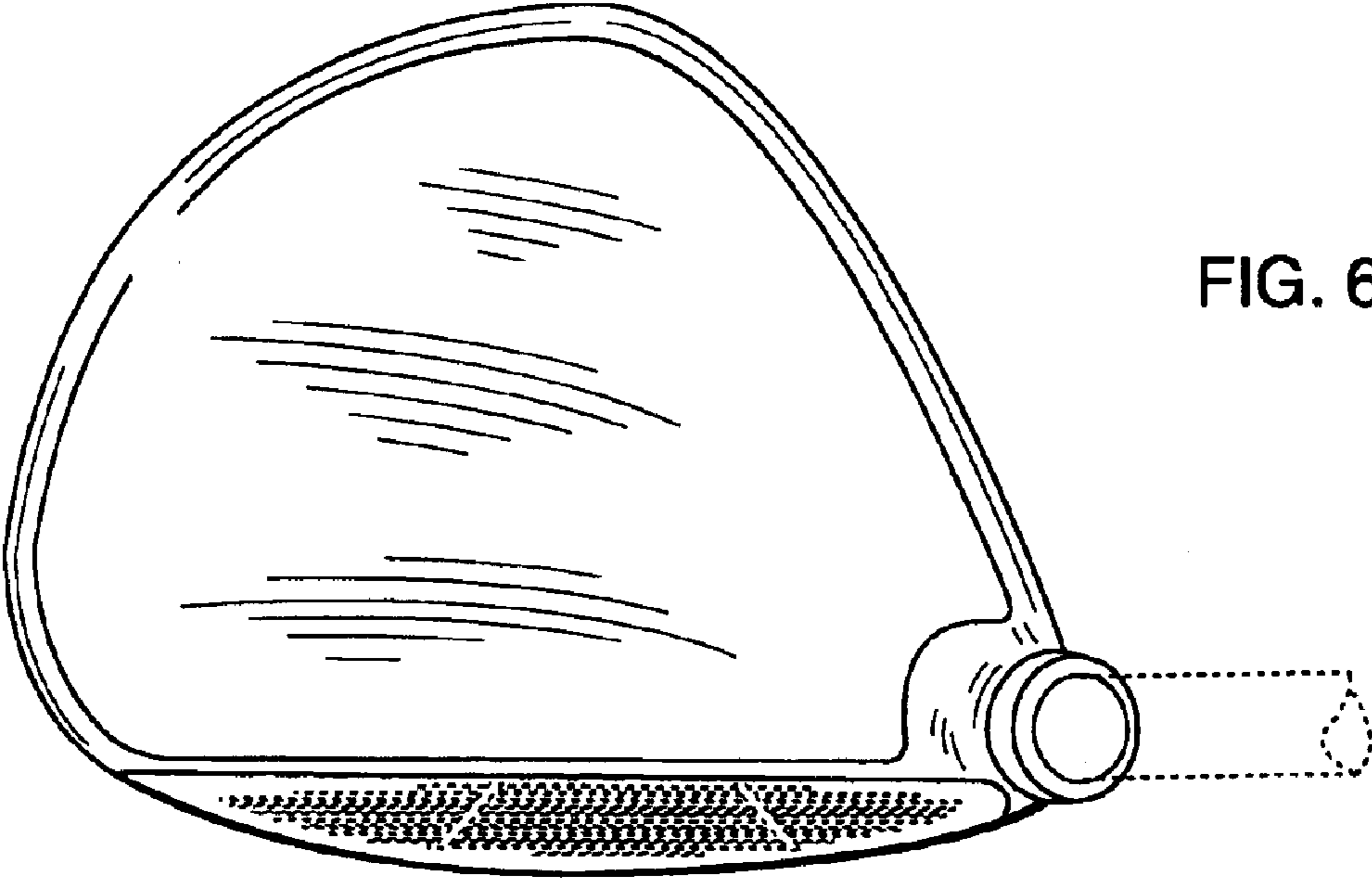

FIG. 6

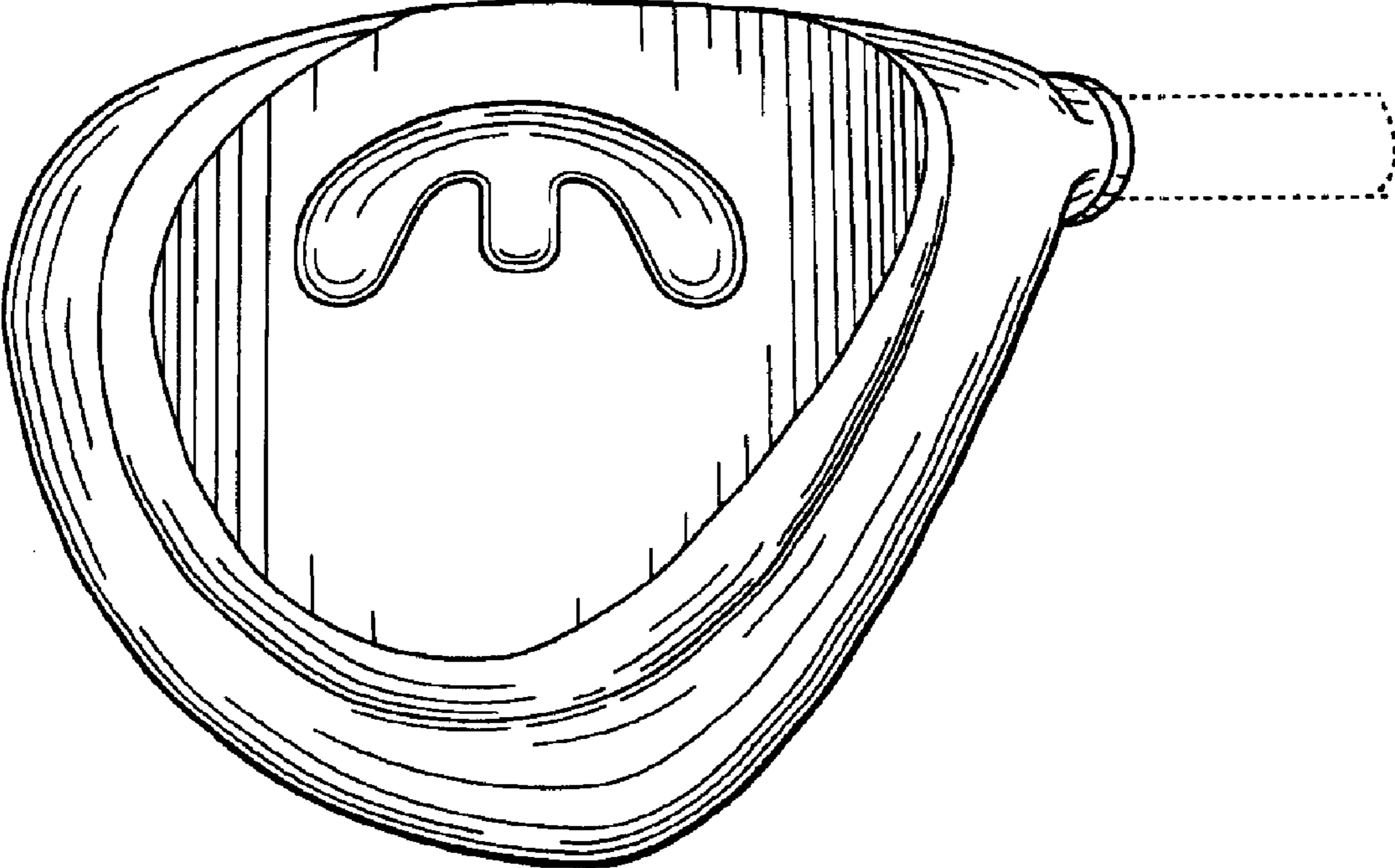

FIG. 7