

US00D504419S

(12) **United States Design Patent**  
**Bey et al.**

(10) **Patent No.:** **US D504,419 S**  
(45) **Date of Patent:** **\*\* Apr. 26, 2005**

(54) **MICROPHONE BOOM FOR A COMMUNICATIONS HEADSET**

(75) Inventors: **Fadhly Bey**, San Francisco, CA (US);  
**Julian Peck**, San Francisco, CA (US);  
**Kelly Kodama**, Alamo, CA (US);  
**Soohyun Ham**, Santa Cruz, CA (US)

(73) Assignee: **Plantronics, Inc.**, Santa Cruz, CA (US)

(\*\*) Term: **14 Years**

(21) Appl. No.: **29/197,443**

(22) Filed: **Jan. 13, 2004**

(51) **LOC (7) Cl.** ..... **14-01**

(52) **U.S. Cl.** ..... **D14/223; D14/225**

(58) **Field of Search** ..... D14/205, 206,  
D14/223, 225; 181/129, 130; 379/430,  
433; 381/381, 370

(56) **References Cited**

**U.S. PATENT DOCUMENTS**

- 2,360,027 A \* 10/1944 Werner ..... 379/430
- D266,242 S \* 9/1982 Radzelovage ..... D14/225
- D299,335 S \* 1/1989 Wiegel ..... D14/225
- D443,603 S \* 6/2001 Taylor et al. .... D14/206
- D464,943 S \* 10/2002 Lai ..... D14/206

D470,128 S \* 2/2003 Hlas et al. .... D14/223

\* cited by examiner

*Primary Examiner*—Paula A. Greene  
(74) *Attorney, Agent, or Firm*—Peter Hsieh

(57) **CLAIM**

The ornamental design for a microphone boom for a communications headset, as shown and described.

**DESCRIPTION**

FIG. 1 is a lower front right perspective view of a microphone boom for a communications headset, the broken line drawings of an illustrative speaker and ear piece are for illustrative purposes only and form no part of the claimed design.

FIG. 2 is a lower rear left perspective view of the microphone boom.

FIG. 3 is a right side elevational view of the microphone boom, the left side elevational view of the microphone boom being a mirror image thereof.

FIG. 4 is a front elevational view of the microphone boom.

FIG. 5 is a rear elevational view of the microphone boom.

FIG. 6 is a top plan view of the microphone boom; and,

FIG. 7 is a bottom plan view of the microphone boom.

**1 Claim, 3 Drawing Sheets**

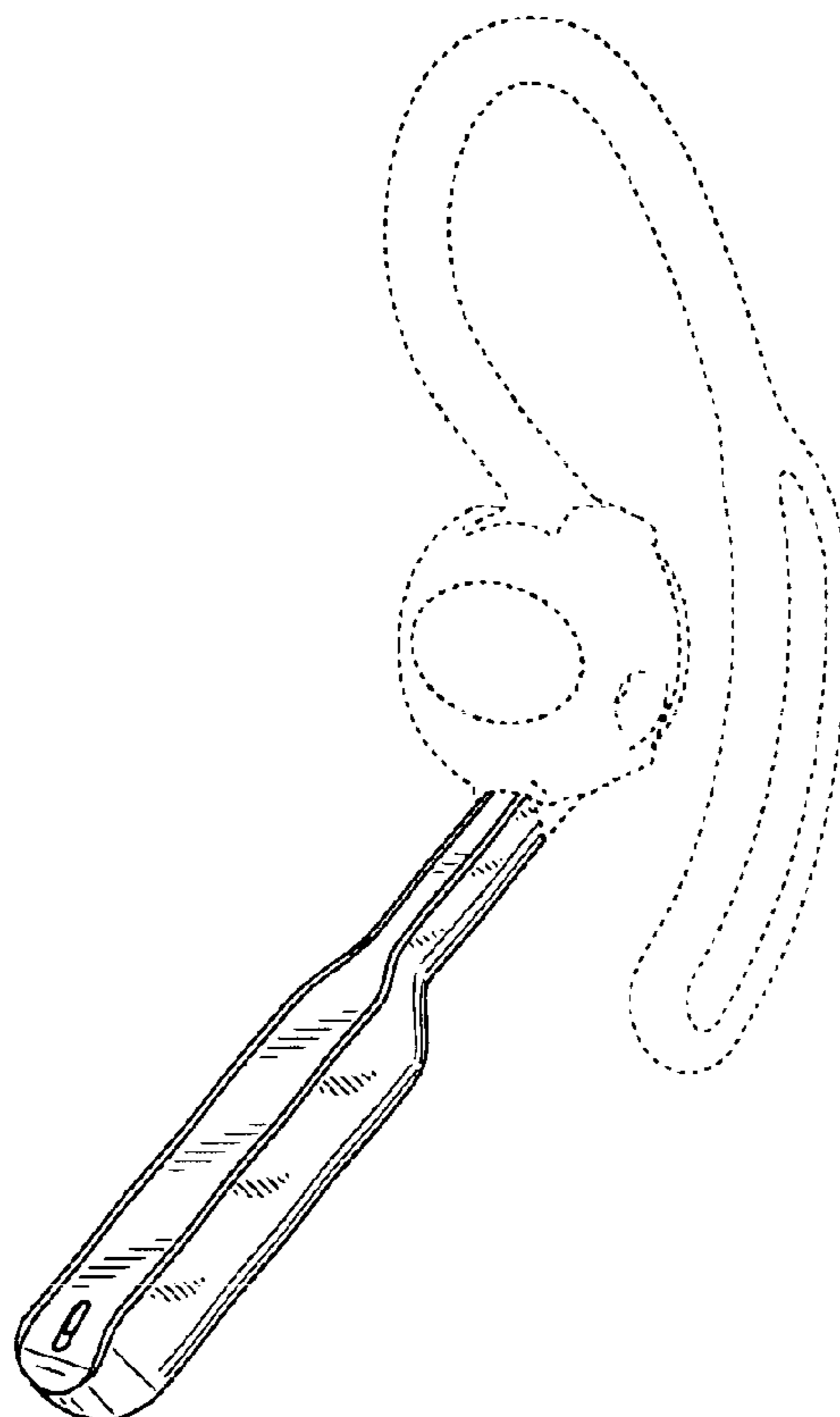

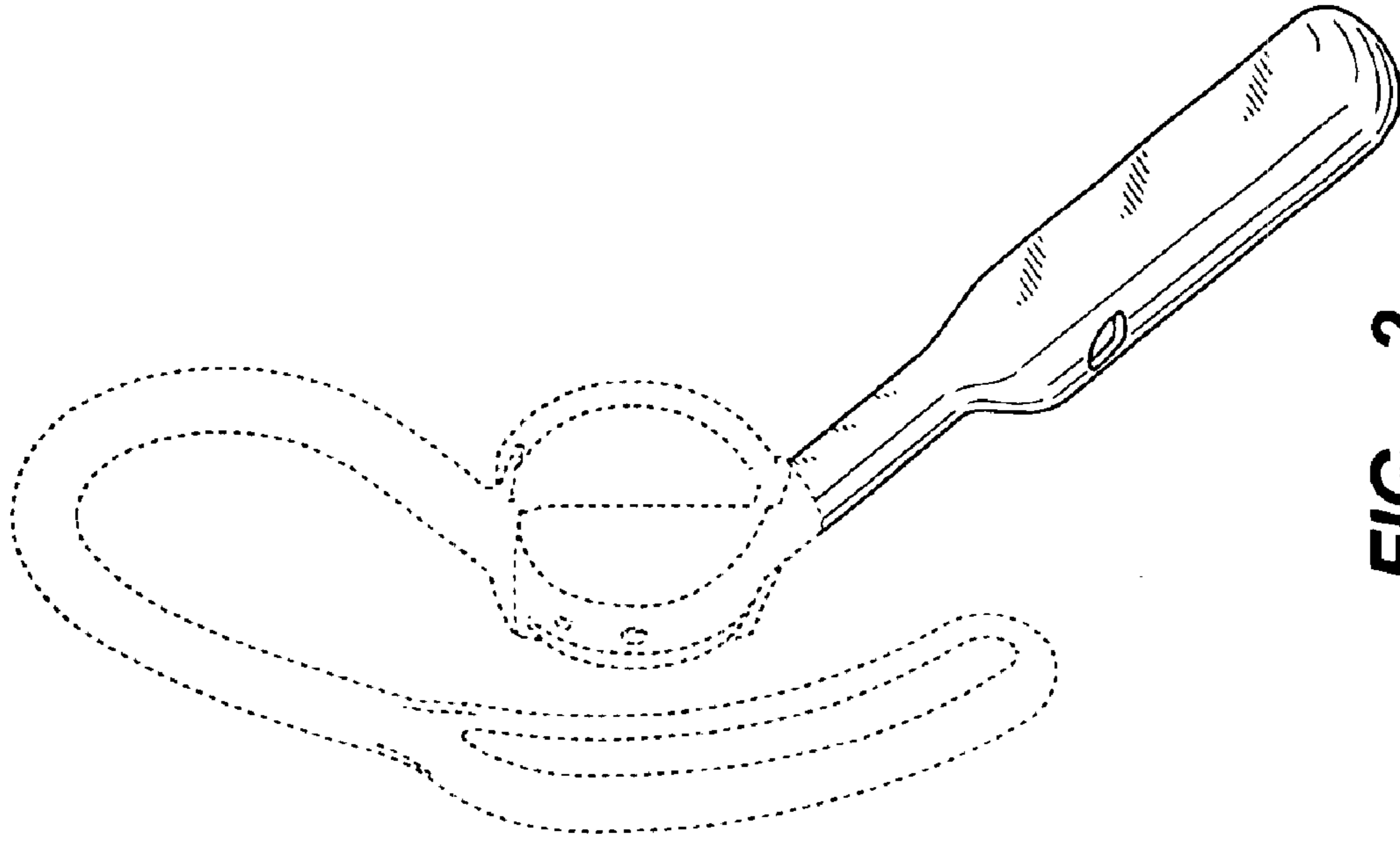

**FIG. 2**

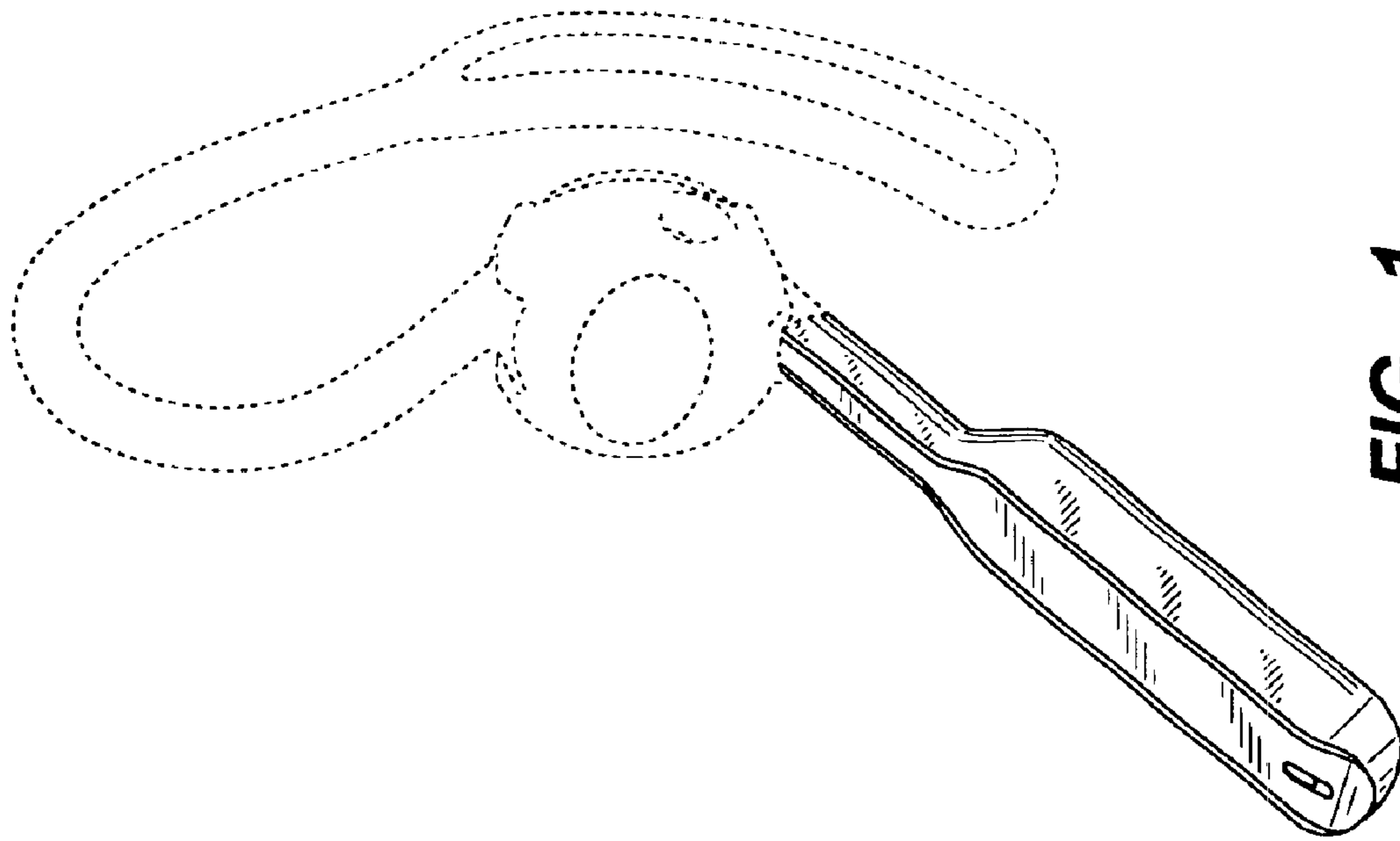

**FIG. 1**

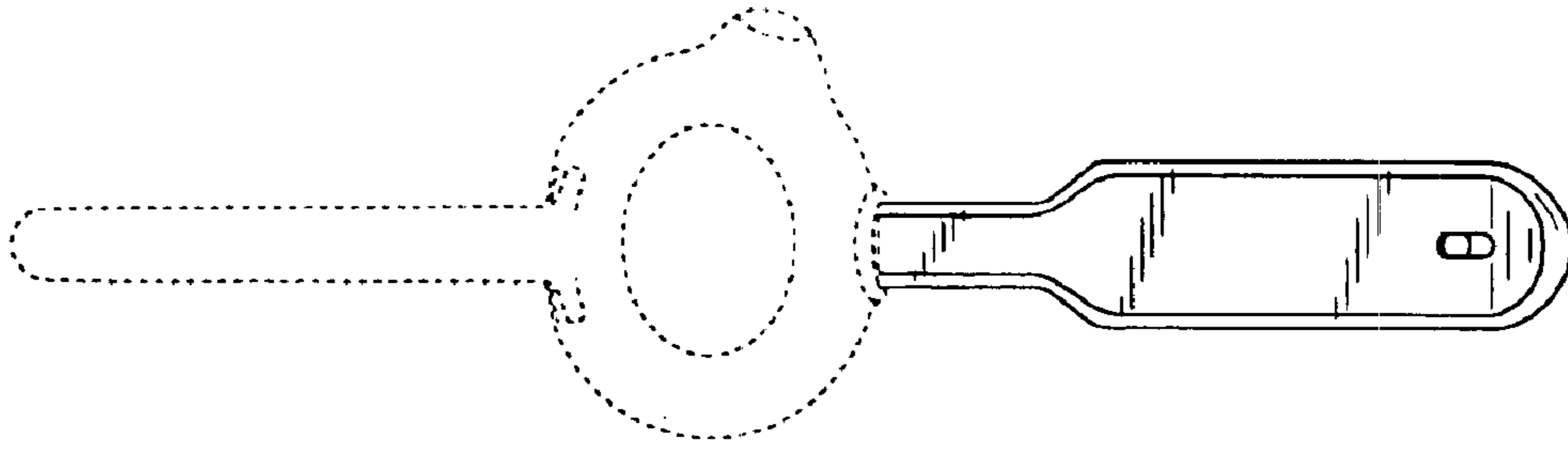

FIG. 4

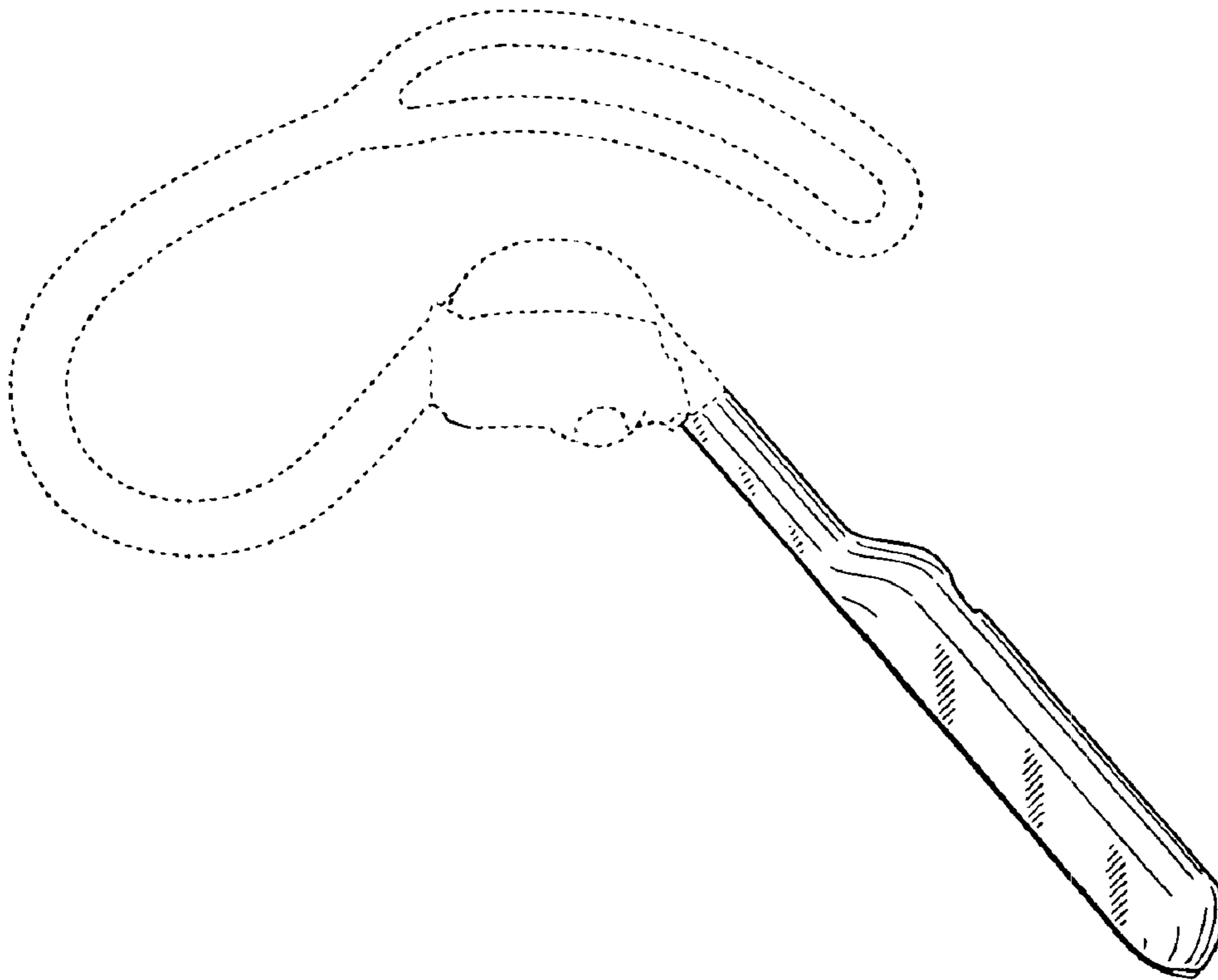
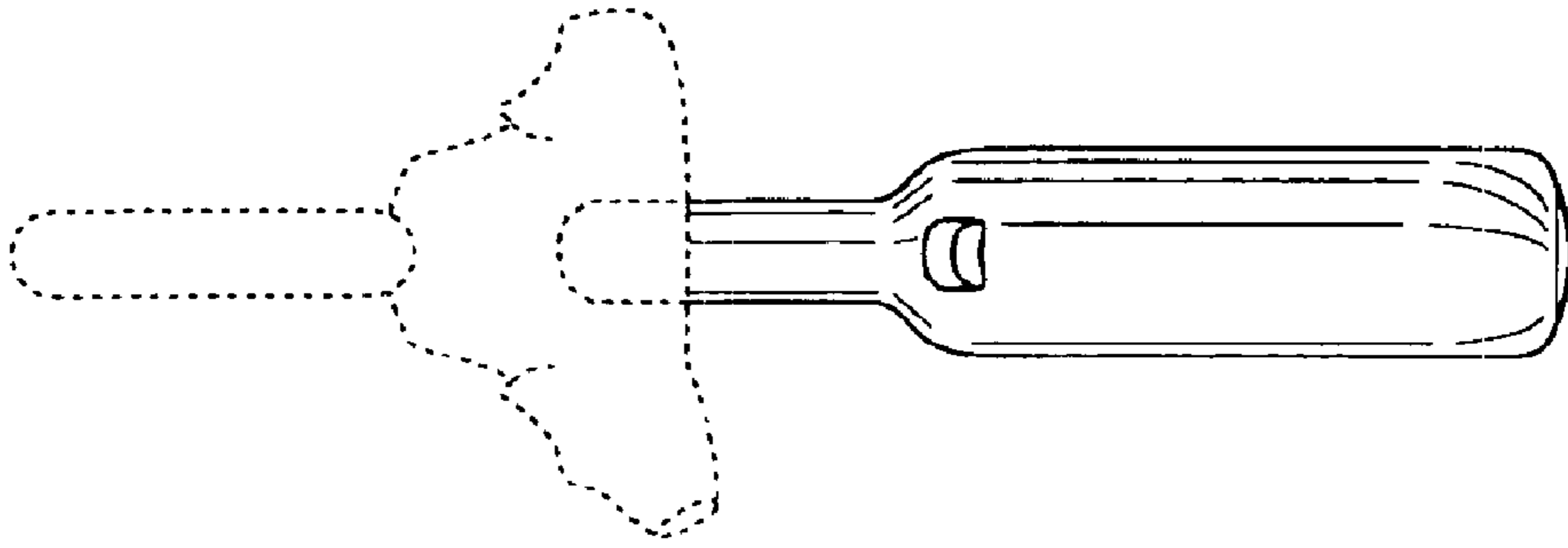
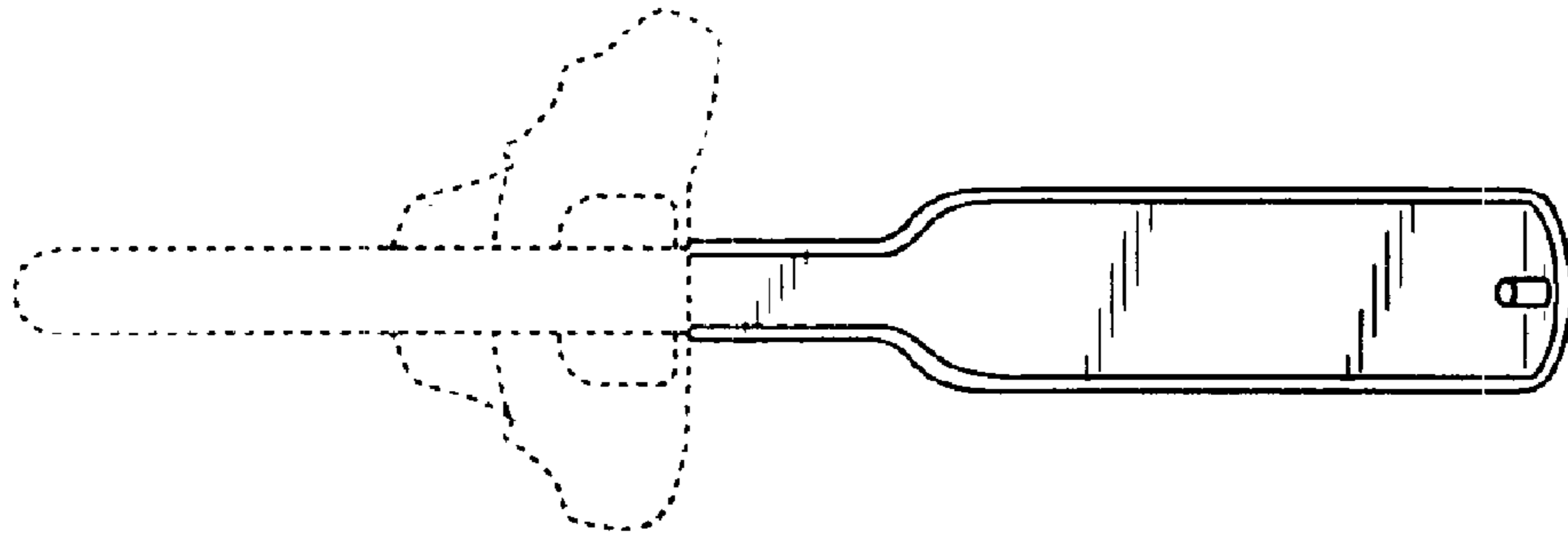

FIG. 3



**FIG. 7**



**FIG. 6**

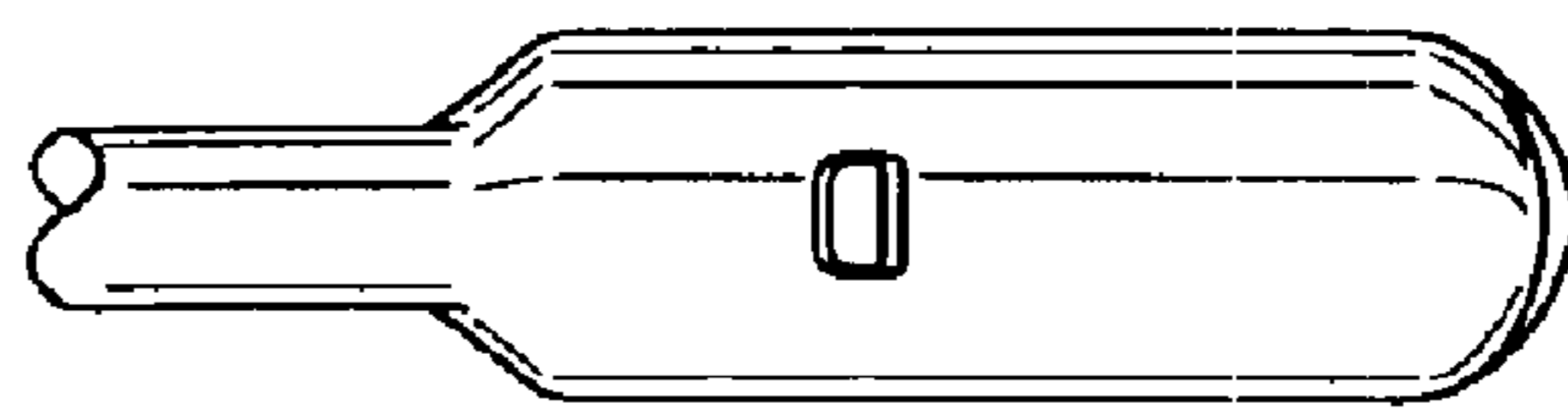

**FIG. 5**