

US00D504341S

(12) **United States Design Patent**  
**Graef et al.**

(10) **Patent No.: US D504,341 S**

(45) **Date of Patent: \*\* Apr. 26, 2005**

(54) **MEASUREMENT INSTRUMENT**

(75) Inventors: **David Graef**, Campbell Hall, NY (US);  
**Phil Stearns**, Colorado Springs, CO  
(US); **Norio Shimomura**, Tokyo (JP);  
**Satoshi Hayasaka**, Tokyo (JP)

(73) Assignee: **LeCroy Corporation**, Chestnut Ridge,  
NY (US)

(\*\*) Term: **14 Years**

(21) Appl. No.: **29/191,576**

(22) Filed: **Oct. 9, 2003**

(51) **LOC (7) Cl.** ..... **10-04**

(52) **U.S. Cl.** ..... **D10/76**

(58) **Field of Search** ..... D10/76; 702/189,  
702/65, 125, 66-68; 324/555; 345/440,  
175, 173, 440.1

(56) **References Cited**

**U.S. PATENT DOCUMENTS**

- D282,351 S \* 1/1986 Nord et al.
- 4,766,425 A \* 8/1988 Tallman et al.
- 4,818,931 A \* 4/1989 Naegeli et al.
- 4,821,030 A \* 4/1989 Batson et al.
- 4,823,283 A \* 4/1989 Diehm et al.
- 5,003,249 A \* 3/1991 Bird
- D335,093 S \* 4/1993 Holmen et al.
- 5,250,935 A \* 10/1993 Jonker et al.

- D377,319 S \* 1/1997 Amano et al.
- D423,383 S \* 4/2000 Fernandez et al.
- 6,195,617 B1 \* 2/2001 Miller
- 6,311,138 B1 \* 10/2001 Miller
- 6,720,776 B1 \* 4/2004 Anderson et al. .... 324/555
- 2001/0001850 A1 \* 5/2001 Miller ..... 702/67
- 2003/0062906 A1 \* 4/2003 Anderson
- 2003/0191591 A1 \* 10/2003 Iiyoshi et al. .... 702/68
- 2003/0204342 A1 \* 10/2003 Law et al. .... 702/65

\* cited by examiner

*Primary Examiner*—Antoine D. Davis

(74) *Attorney, Agent, or Firm*—Frommer Lawrence &  
Haug LLP; William S. Frommer

(57) **CLAIM**

The ornamental design for the “measurement instrument,”  
as shown.

**DESCRIPTION**

FIG. 1 is a front elevational view of a first embodiment of  
the measurement instrument showing our new design;  
FIG. 2 is a top plan view thereof;  
FIG. 3 is a left side elevational view thereof;  
FIG. 4 is a right side elevational view thereof;  
FIG. 5 is a rear elevational view thereof; and,  
FIG. 6 is a bottom plan view thereof.

The broken line shown in FIG. 3 is for illustrative purposes  
only and forms no part of the claimed design.

**1 Claim, 6 Drawing Sheets**

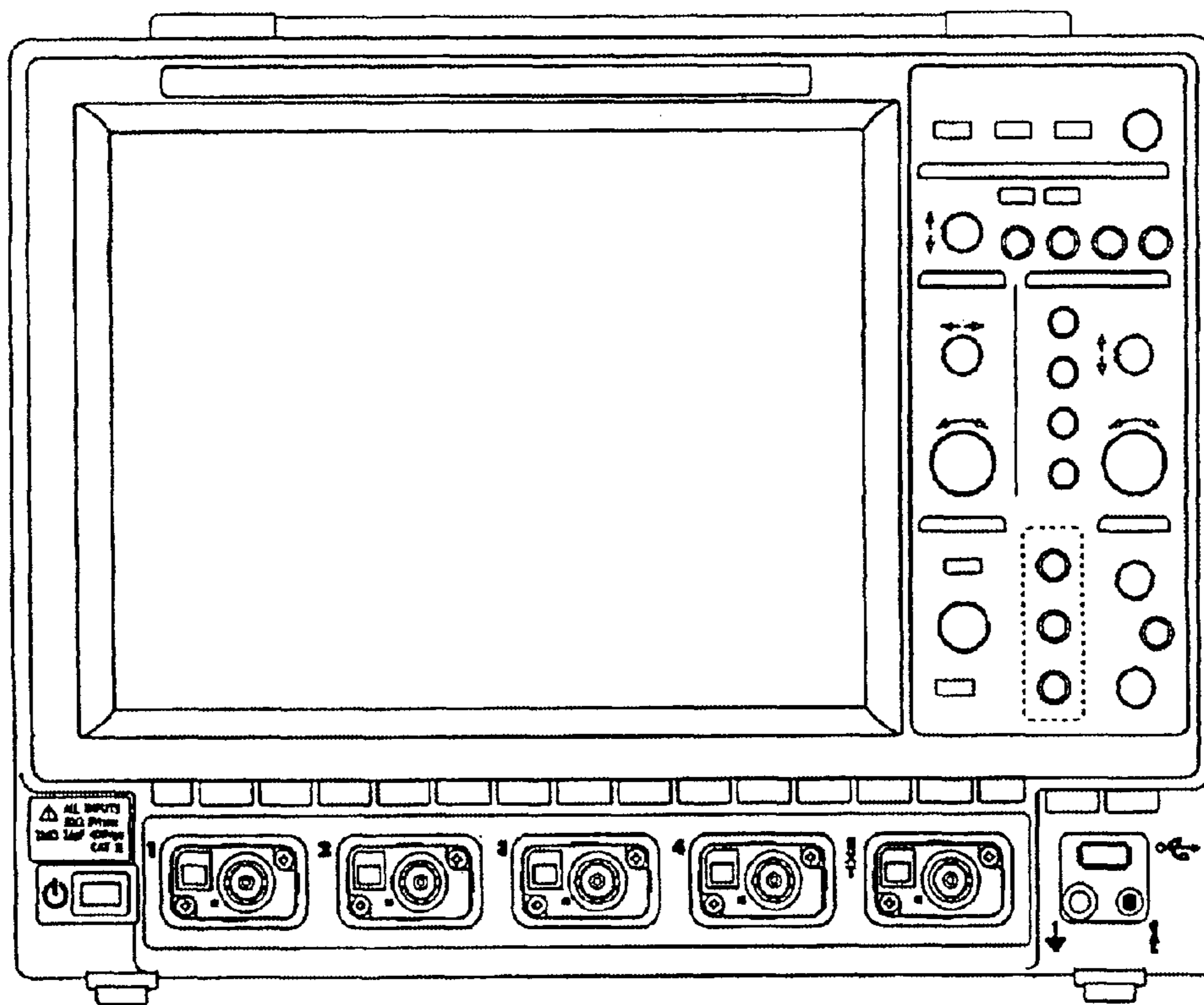

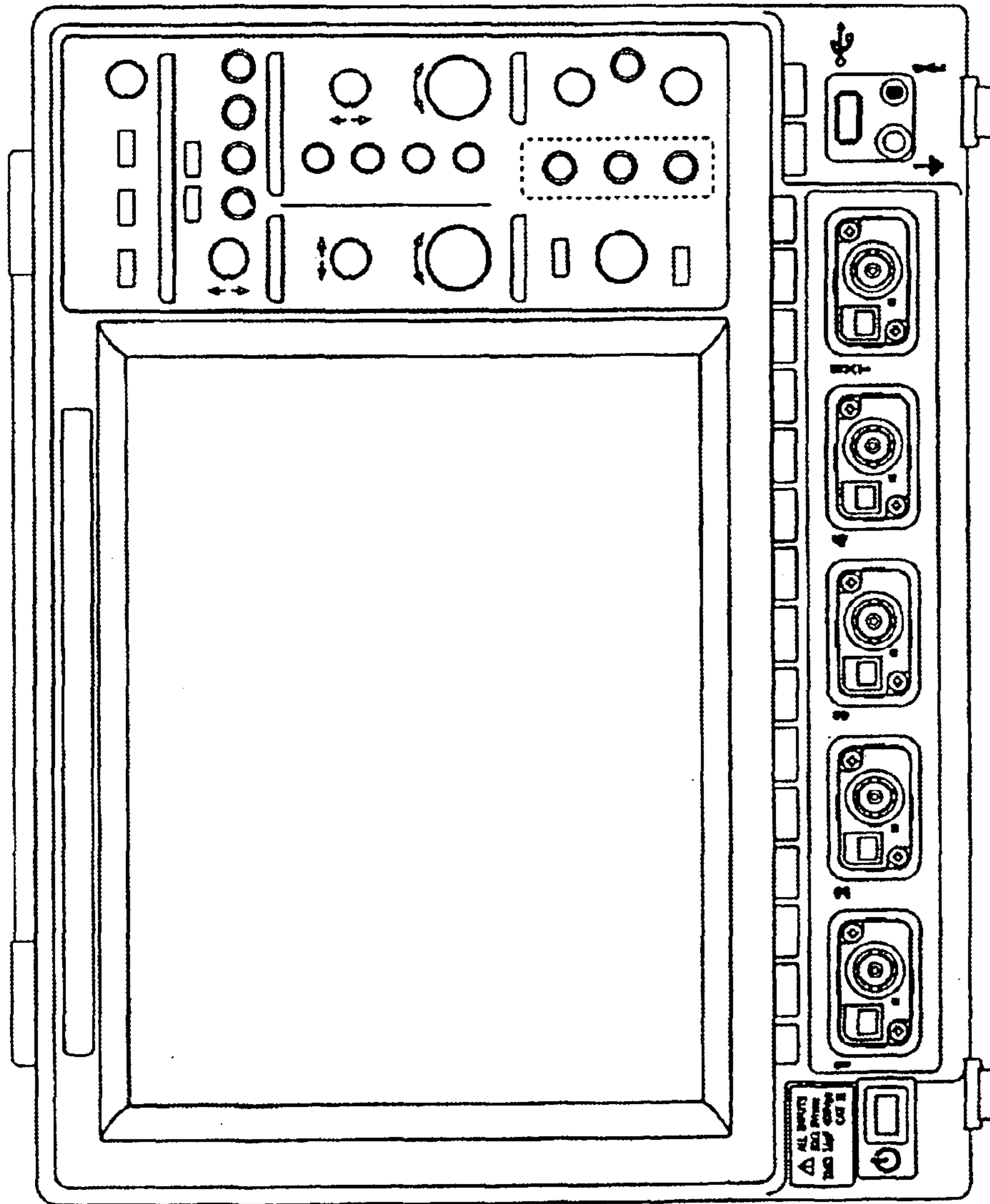

FIG. 1

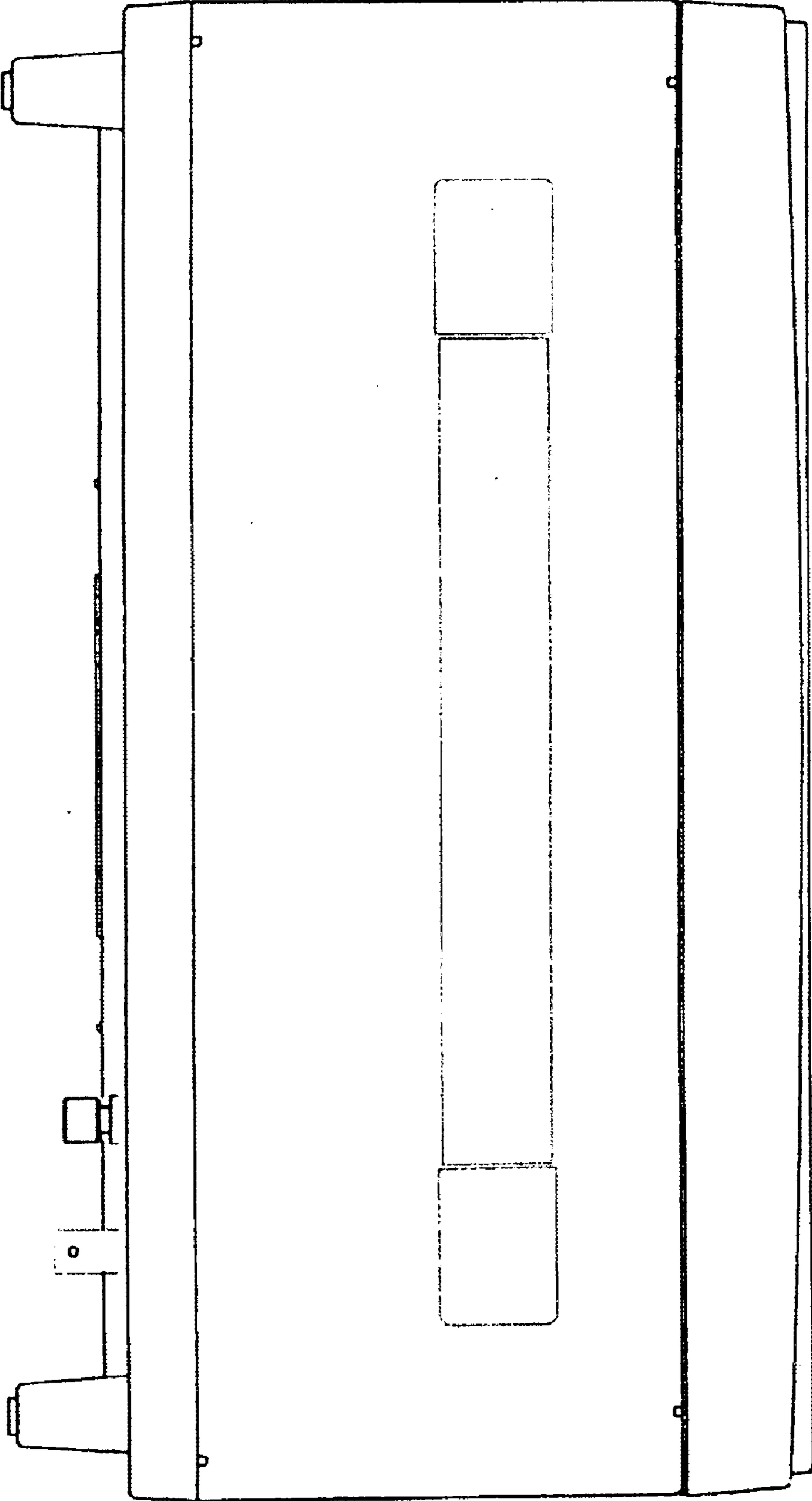

FIG. 2

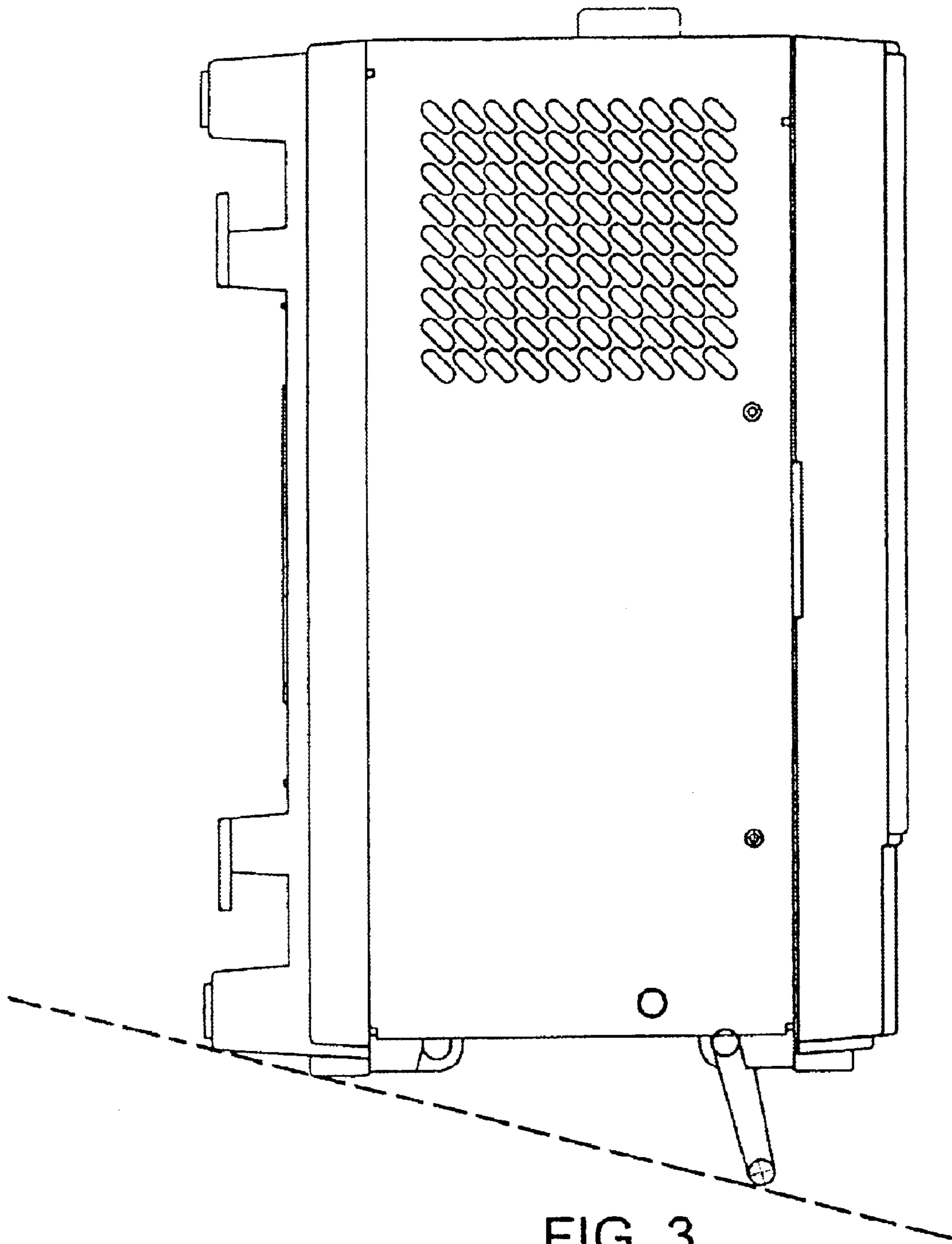

FIG. 3

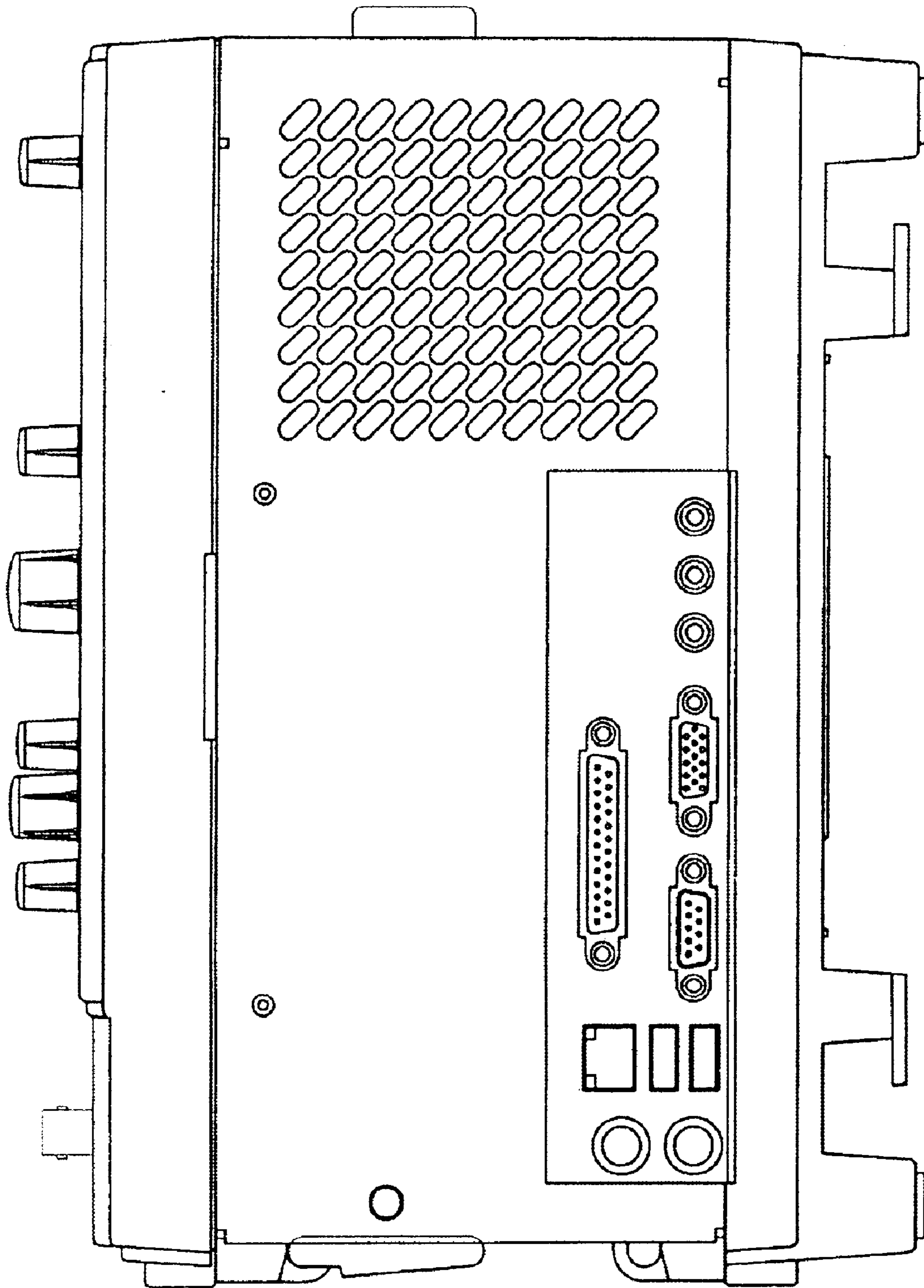

FIG. 4

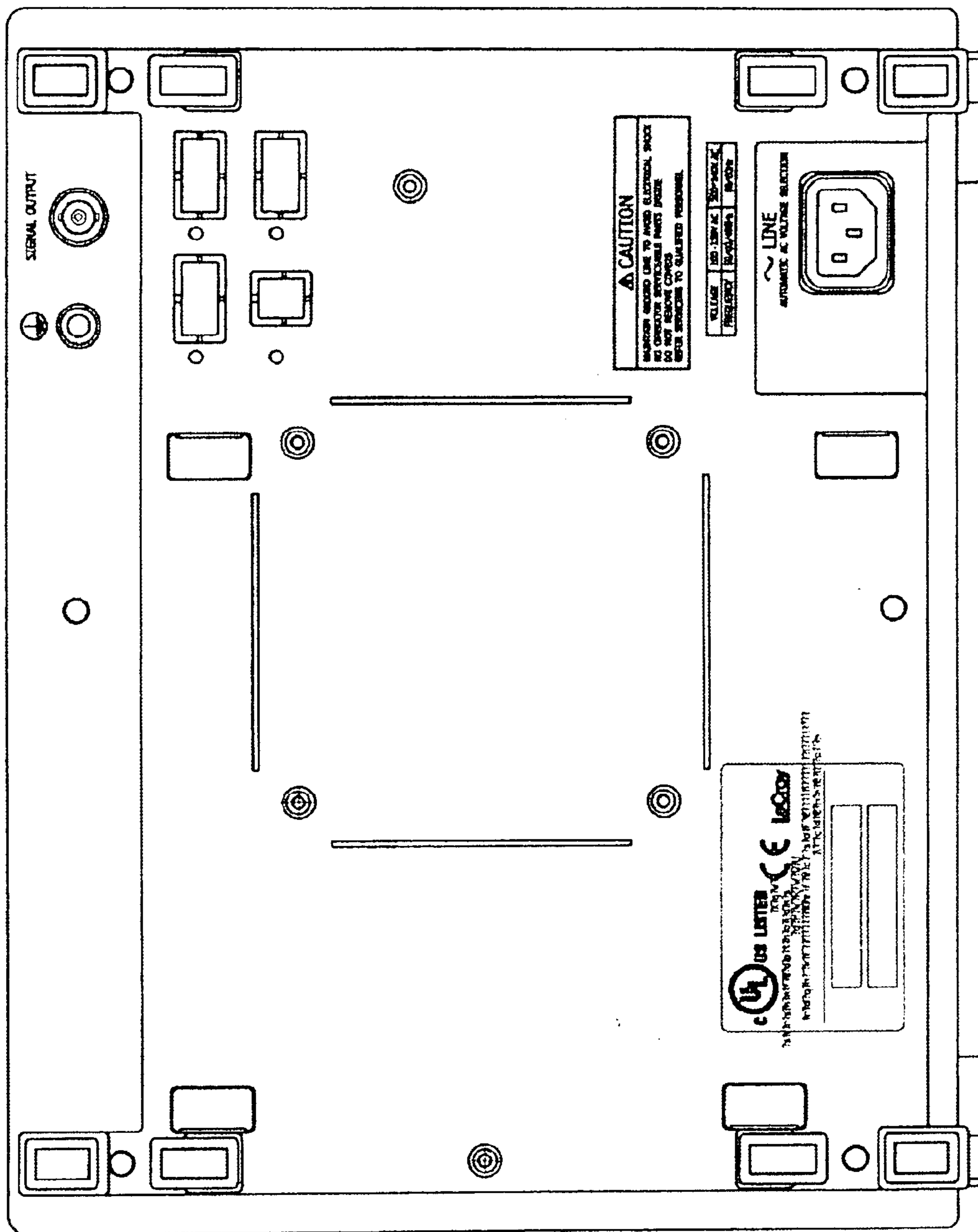

FIG. 5

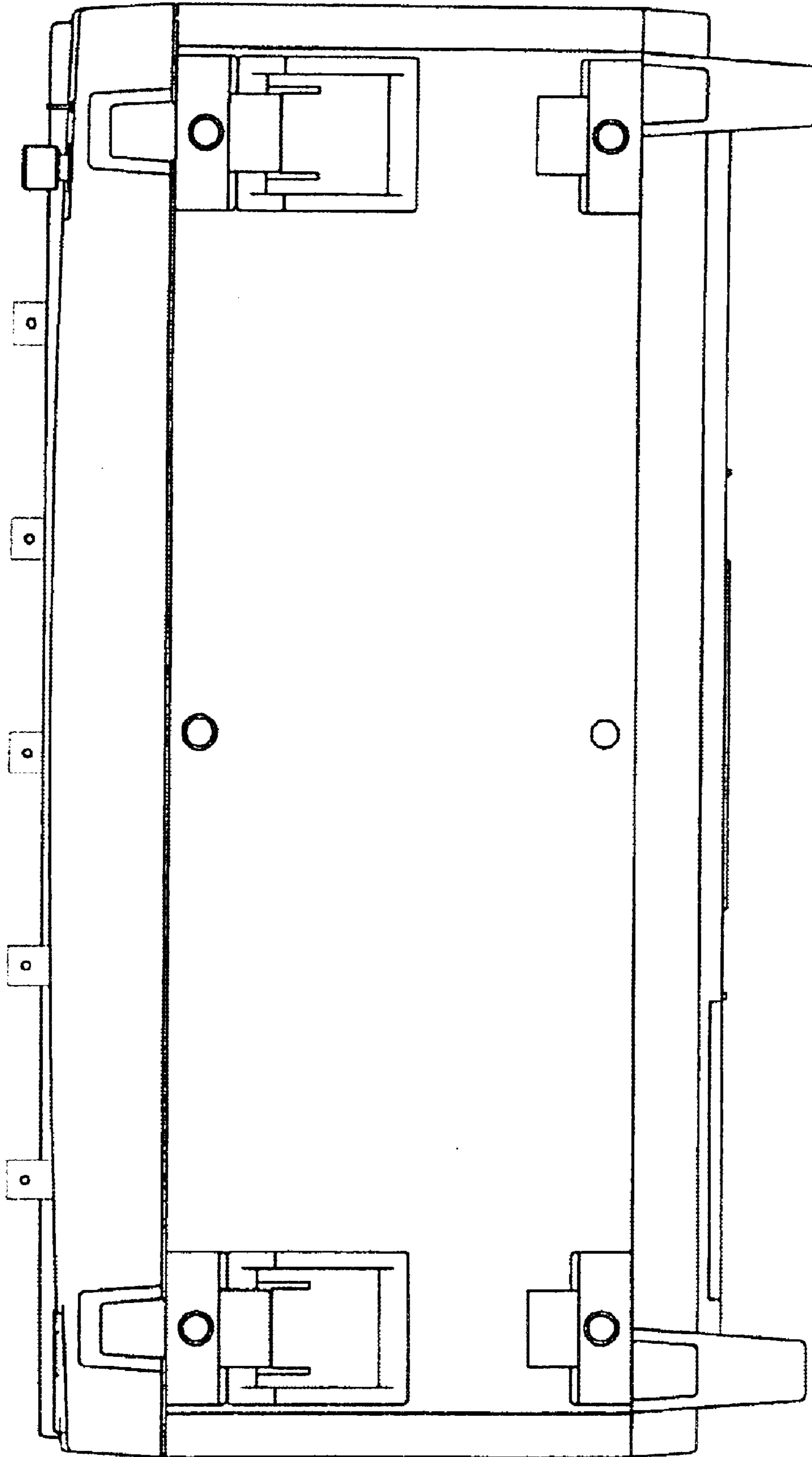

FIG. 6