

US00D504336S

(12) **United States Design Patent**  
**Mason**

(10) **Patent No.:** **US D504,336 S**  
(45) **Date of Patent:** **\*\* Apr. 26, 2005**

(54) **DRYWALL ELECTRICAL BOX CUT OUT  
TEMPLATE**

(76) **Inventor:** **Richard W. Mason**, 514 Wolf Rd.,  
Avon, IL (US) 61415

(\*\*) **Term:** **14 Years**

(21) **Appl. No.:** **29/209,099**

(22) **Filed:** **Jul. 12, 2004**

(51) **LOC (7) Cl.** ..... **10-04**

(52) **U.S. Cl.** ..... **D10/64**

(58) **Field of Search** ..... D10/64; 33/528,  
33/563, DIG. 10

(56) **References Cited**

**U.S. PATENT DOCUMENTS**

3,745,664 A *	7/1973	Altseimer	.....	33/528
3,875,669 A *	4/1975	Hull	.....	33/528
4,228,592 A	10/1980	Badger		
D298,421 S *	11/1988	Tyoff	.....	D10/69
4,793,069 A *	12/1988	McDowell	.....	33/528
4,949,462 A	8/1990	Spencer		
5,172,483 A *	12/1992	Yocono et al.	.....	33/528

5,222,303 A	6/1993	Jardine		
5,615,490 A	4/1997	Burchell		
5,711,082 A	1/1998	Olivo		
5,813,130 A *	9/1998	MacDowell	.....	33/528
5,860,219 A	1/1999	Wilkinson		
D406,537 S	3/1999	Sharp		
6,403,883 B1 *	6/2002	Morgan et al.	.....	174/58
6,463,668 B1 *	10/2002	Williams	.....	33/528

\* cited by examiner

*Primary Examiner*—Antoine D. Davis

(57) **CLAIM**

The ornamental design for a drywall electrical box cut out template, as shown and described.

**DESCRIPTION**

FIG. 1 is a front elevational view of a drywall electrical box cut out template showing my new design; FIG. 2 is a rear elevational view thereof; FIG. 3 is a right side elevational view thereof; FIG. 4 is a left side elevational view thereof; FIG. 5 is a top plan view thereof; and, FIG. 6 is a perspective view thereof.

**1 Claim, 3 Drawing Sheets**

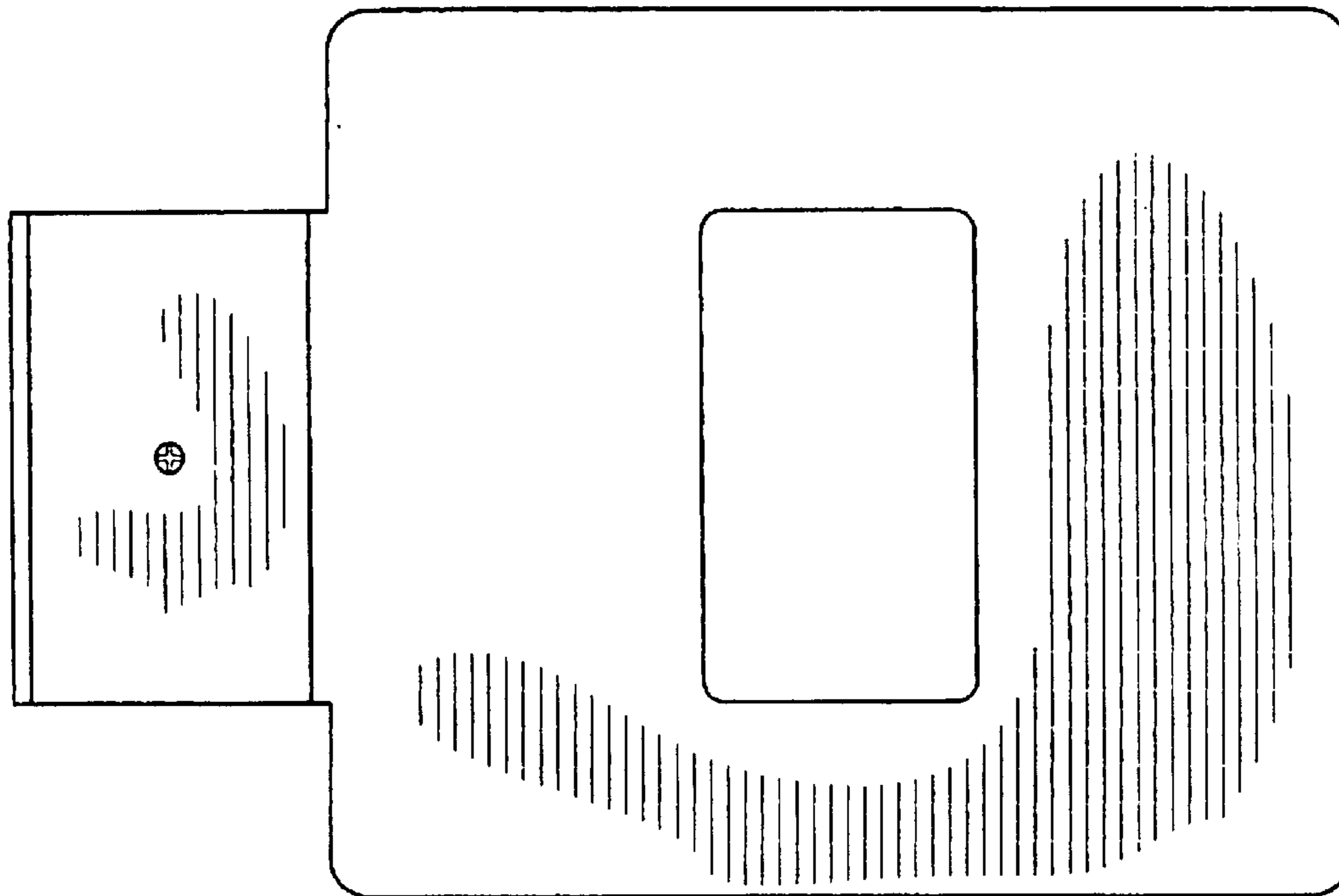

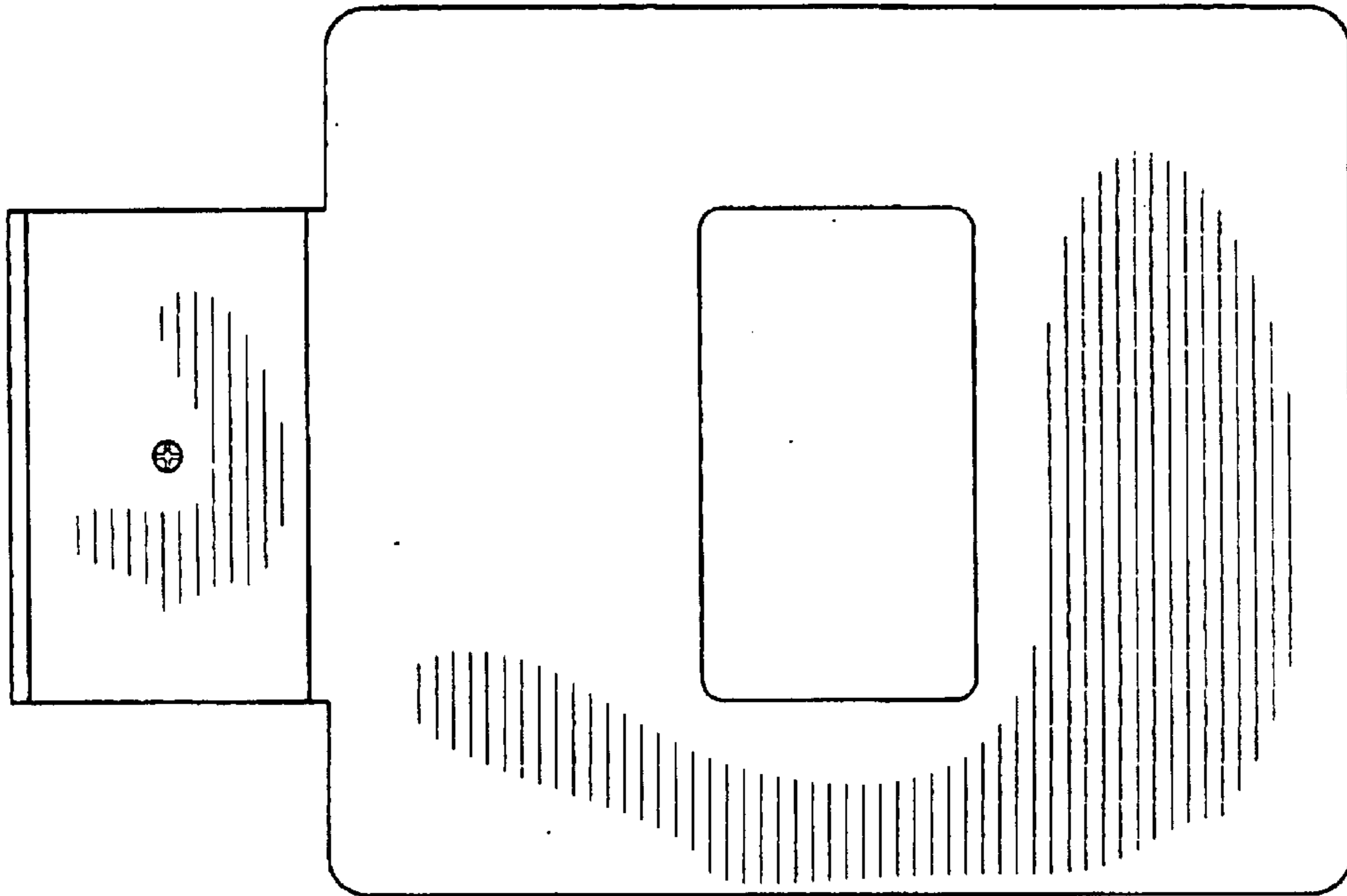

FIG. 1

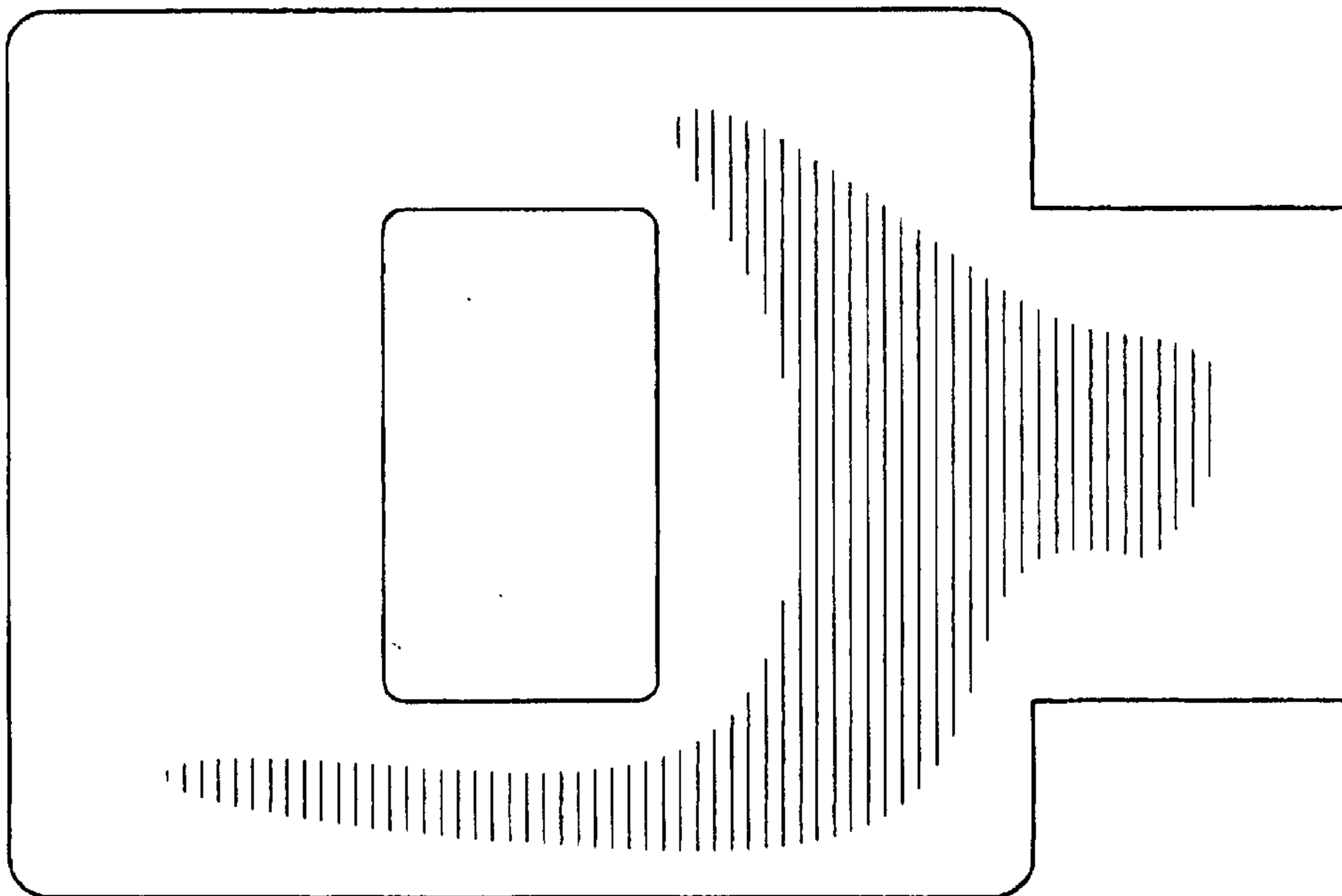

FIG. 2

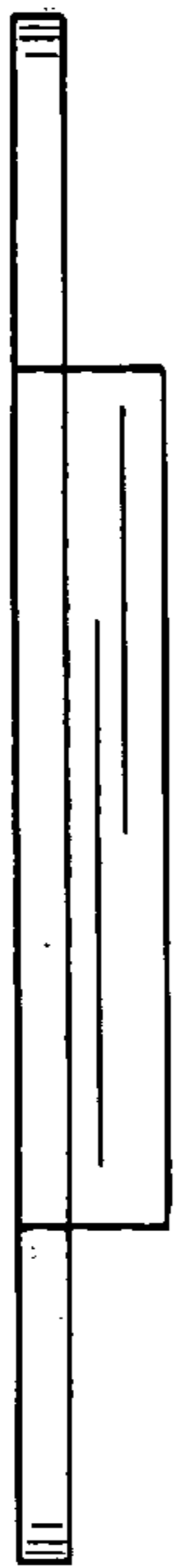

FIG. 3

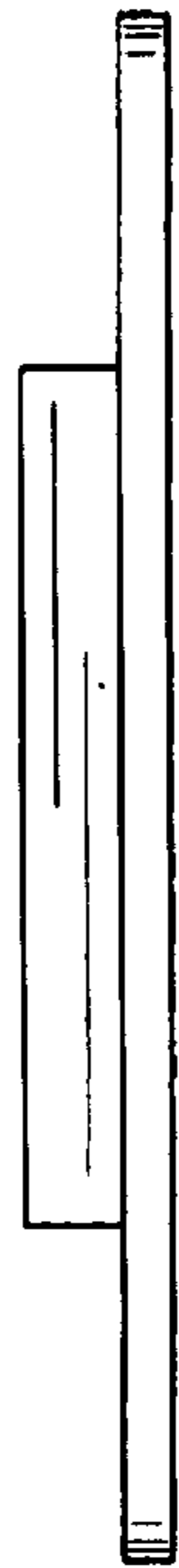

FIG. 4

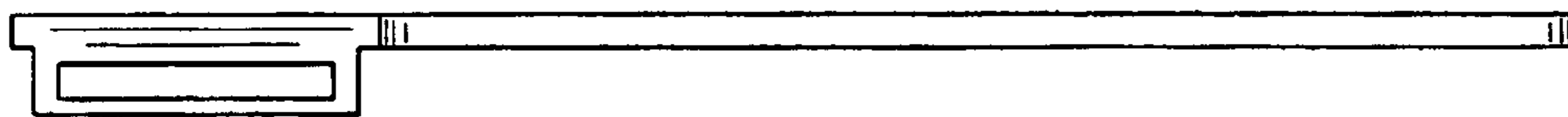

FIG. 5

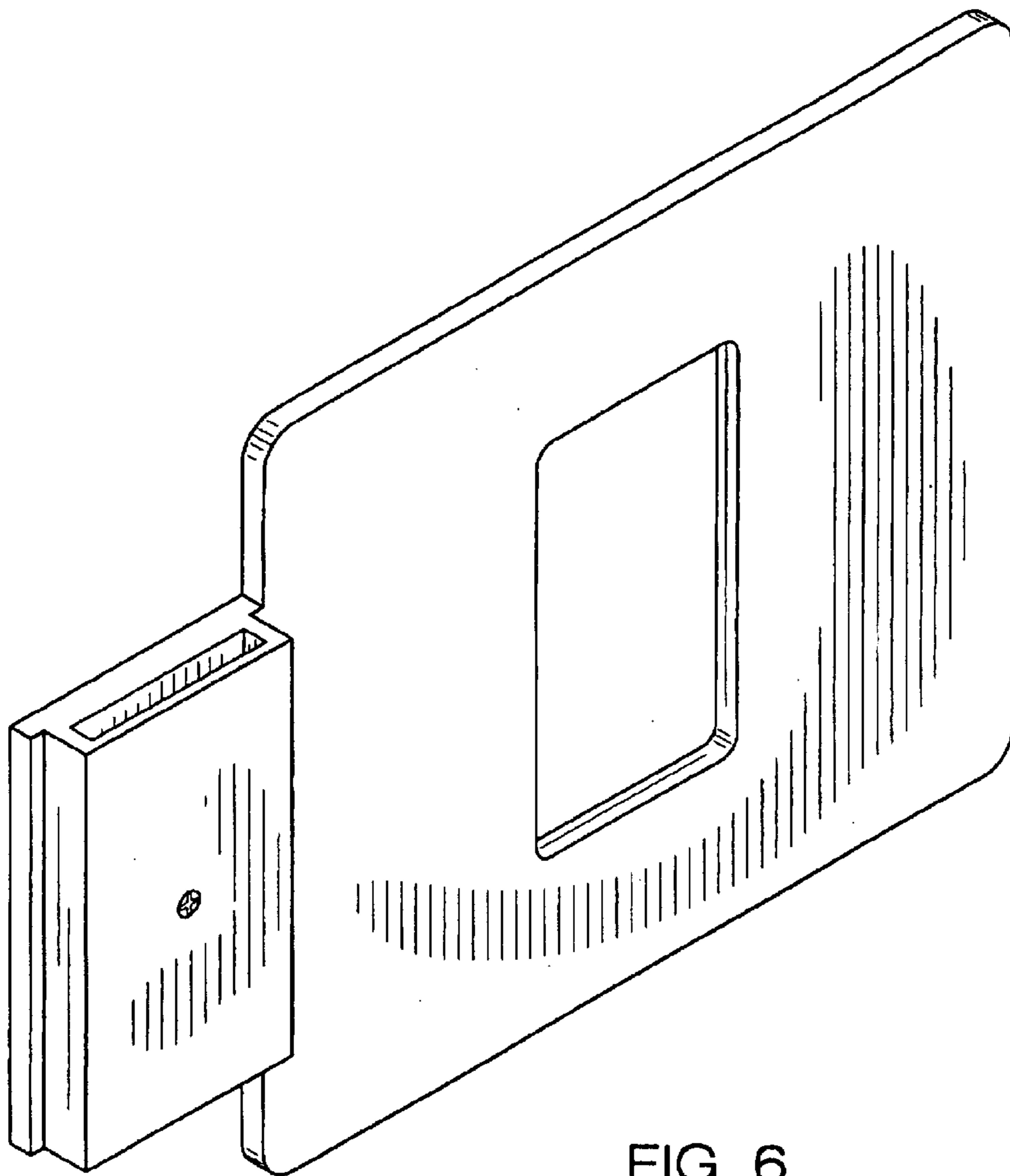

FIG. 6