

US00D504318S

(12) **United States Design Patent**
Lane et al.

(10) **Patent No.:** **US D504,318 S**
(45) **Date of Patent:** **** Apr. 26, 2005**

(54) **CONTAINER**

(75) Inventors: **Gordon Lane**, Valencia, CA (US);
Michael Rodero, Roxbury, CT (US);
Jason M. Morenikeji, London (GB)

(73) Assignee: **Societe Des Produits Nestle S.A.**,
Vevey (CH)

(**) **Term:** **14 Years**

(21) Appl. No.: **29/192,357**

(22) Filed: **Oct. 23, 2003**

(51) **LOC (7) Cl.** **09-01**

(52) **U.S. Cl.** **D9/529; D9/420; D9/542**

(58) **Field of Search** D9/414, 420, 424,
D9/425, 430, 432, 500, 502-505, 515-516,
520, 529-530, 542-543, 560, 563, 574-575;
D7/602, 612; 215/382-384, 396, 398; 220/669,
675

(56) **References Cited**

U.S. PATENT DOCUMENTS

D63,551 S	12/1923	Beavers	
D129,604 S	* 9/1941	Forgue	D9/500
D179,407 S	12/1956	Bliss	
2,913,140 A	* 11/1959	Vuillemenot	220/210
D211,156 S	* 5/1968	Wilson	D9/542
D237,853 S	12/1975	Katz	
D273,843 S	* 5/1984	Urion	D9/500
4,753,367 A	6/1988	Miller et al.	
D303,762 S	* 10/1989	Cardinal et al.	D9/542
D307,238 S	* 4/1990	May	D9/504

D311,334 S	* 10/1990	Flynn et al.	D9/424
D326,391 S	* 5/1992	Verchere	D7/612
D371,053 S	* 6/1996	Lillelund et al.	D7/612
D384,285 S	* 9/1997	D'Amico et al.	D9/542
5,810,188 A	* 9/1998	Novakoski et al.	220/254.3
6,032,823 A	* 3/2000	Bacon	220/620
D444,067 S	6/2001	Goettner	
D444,387 S	7/2001	Adachi et al.	
D458,508 S	* 6/2002	Thonis et al.	D7/392.1
D467,799 S	* 12/2002	Persson	D9/420

* cited by examiner

Primary Examiner—Carol Rademaker

(74) *Attorney, Agent, or Firm*—Denton L. Anderson;
Sheldon & Mak

(57) **CLAIM**

The ornamental design for a container, as shown and described.

DESCRIPTION

FIG. 1 is a perspective view of the container of the invention;
FIG. 2 is a front view of the container thereof;
FIG. 3 is a rear view of the container thereof;
FIG. 4 is a right side view of the container thereof, the left side view being a mirror image;
FIG. 5 is a top plan view thereof;
FIG. 6 is a bottom plan view thereof; and,
FIG. 7 is a perspective view of the container thereof, shown with the lid in open condition.
The broken lines shown in the drawings are for illustrative purposes only and form no part of the claimed design.

1 Claim, 3 Drawing Sheets

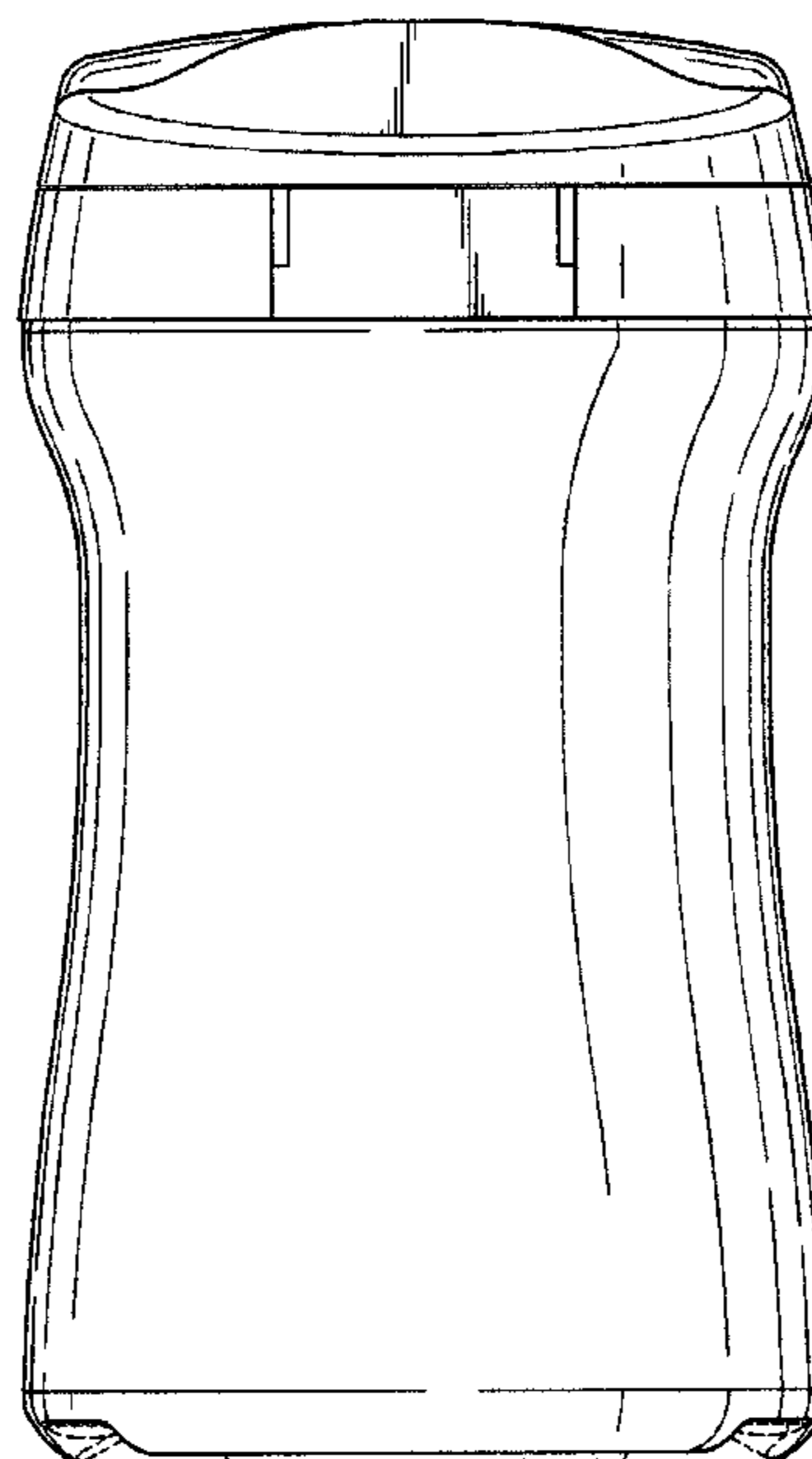
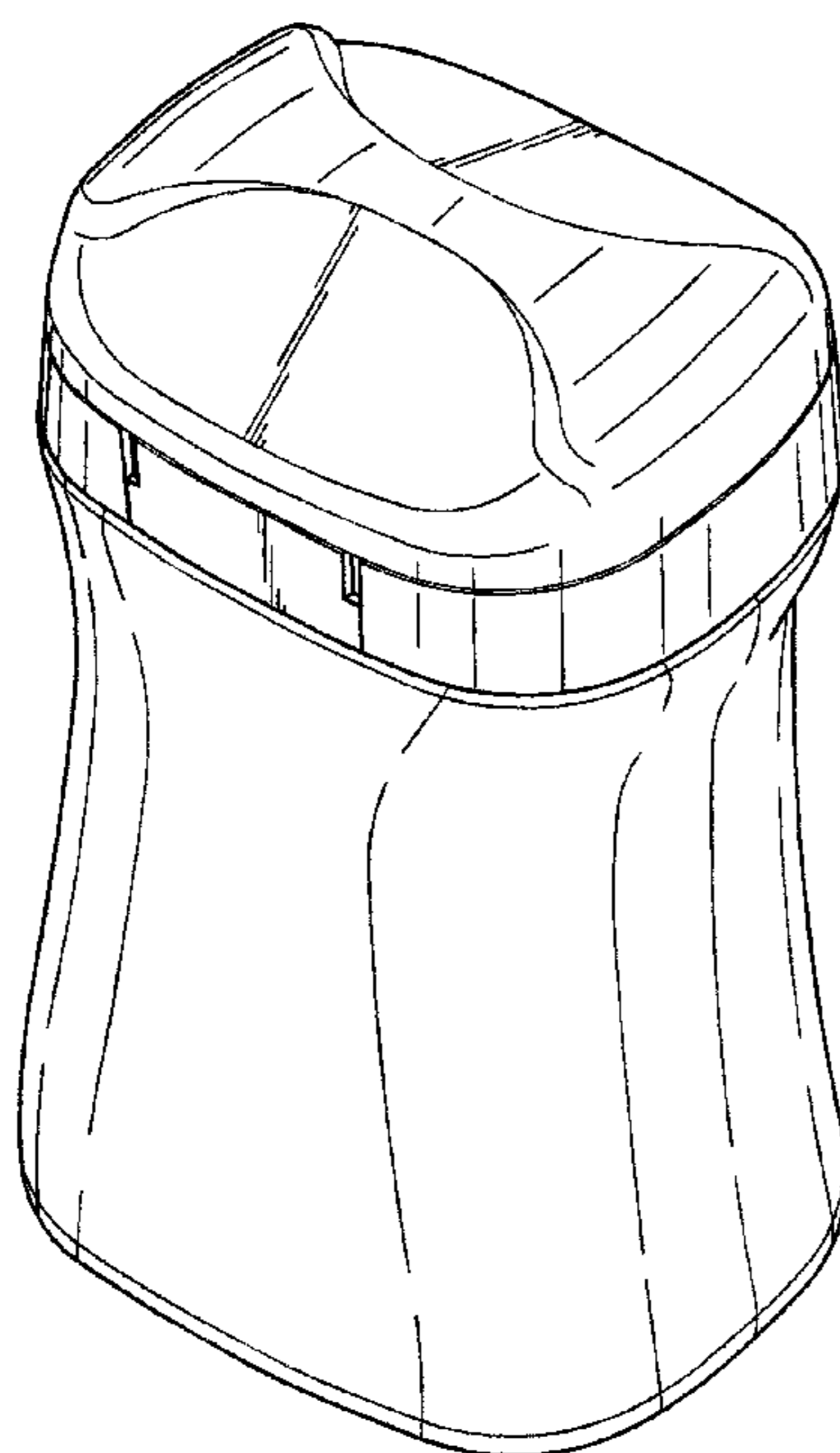

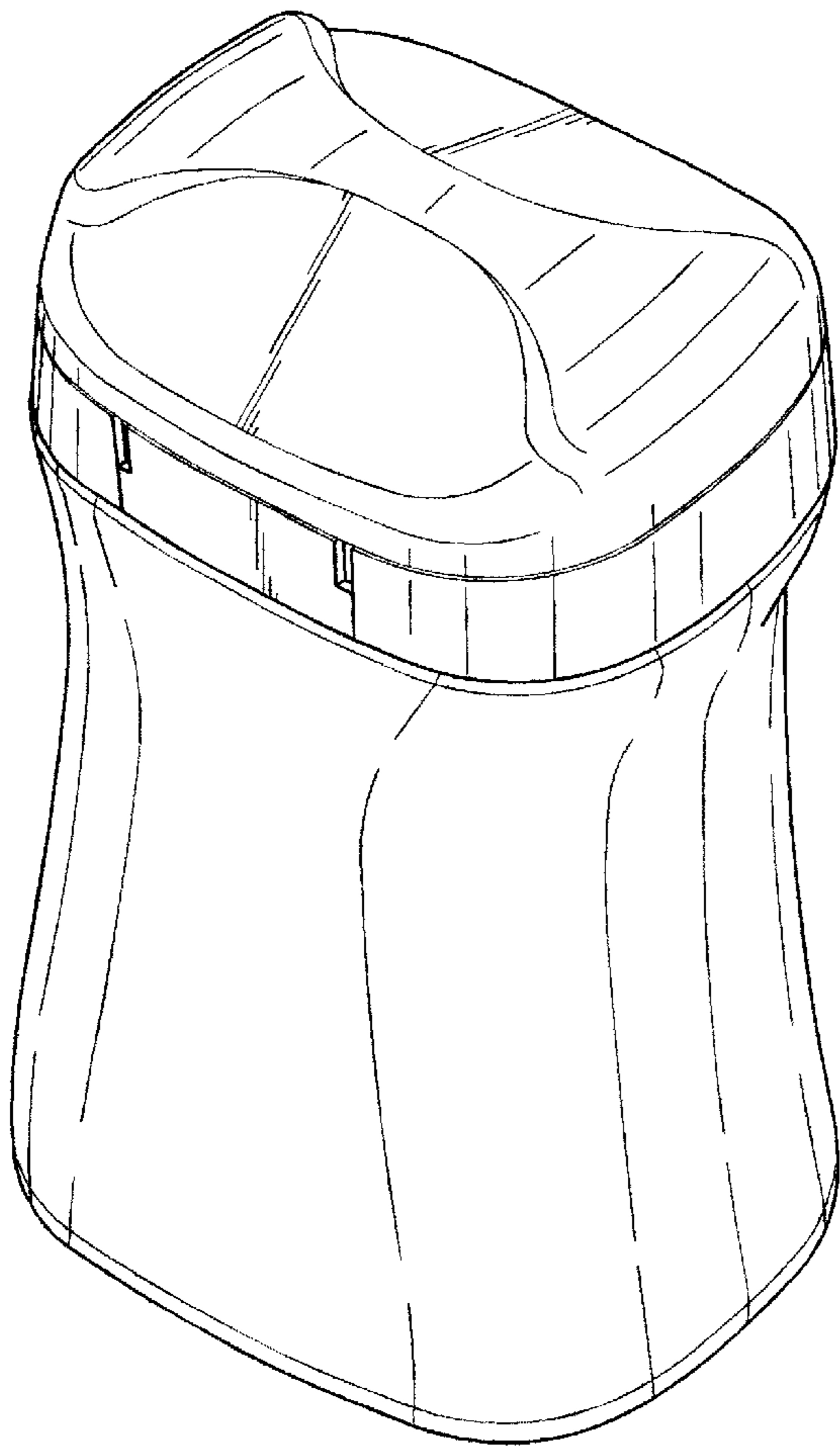

FIG. 1

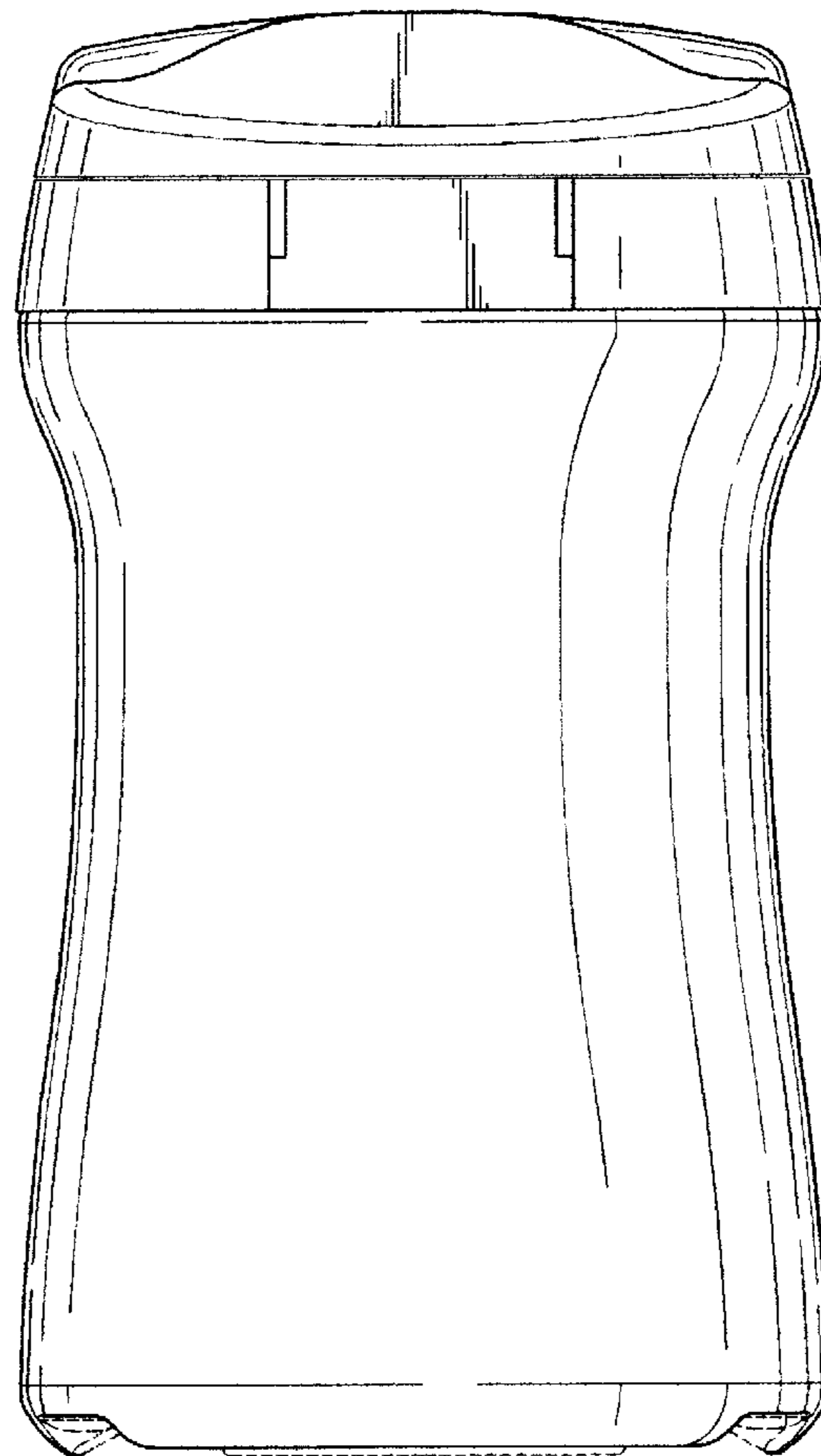

FIG. 2

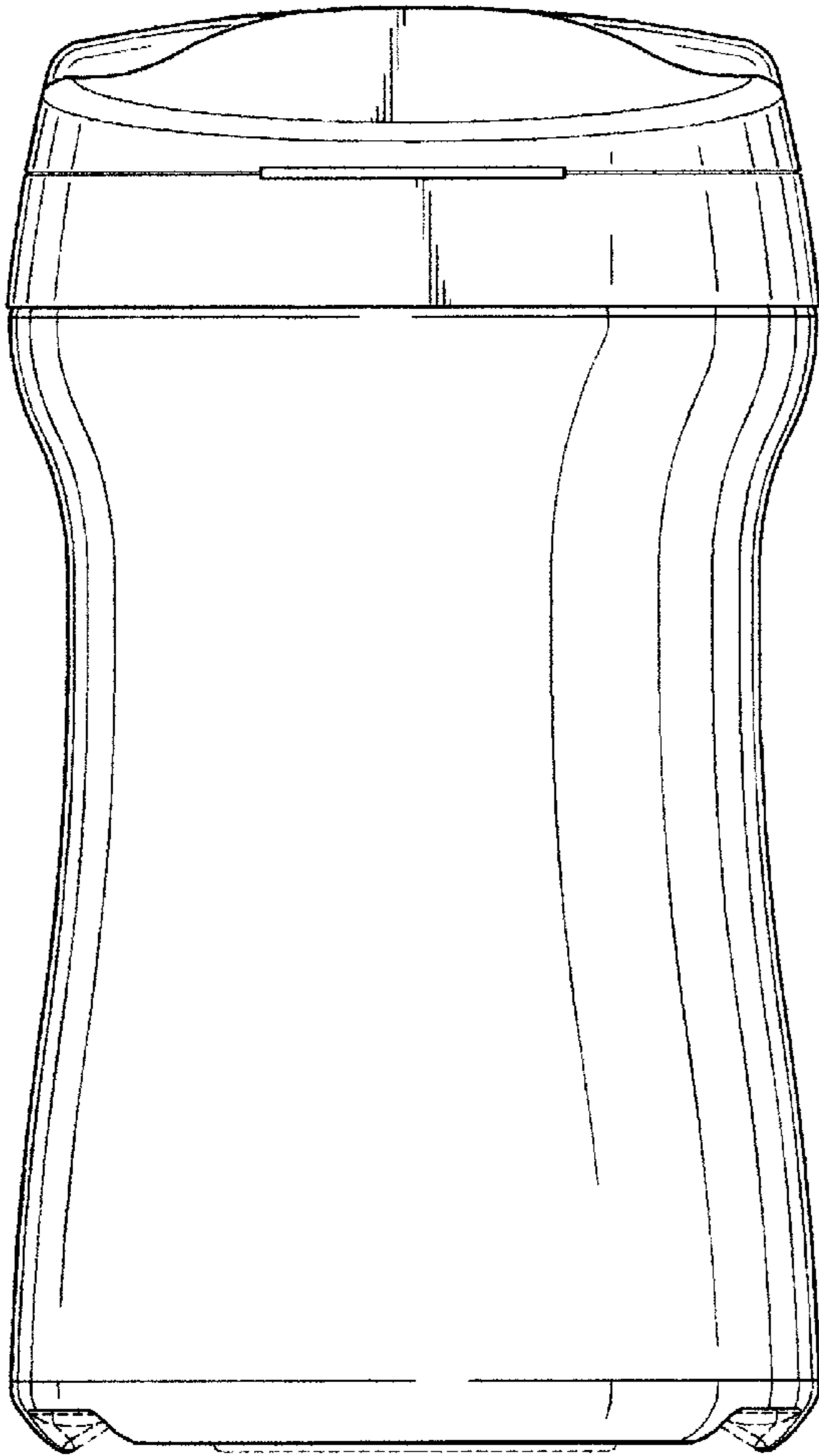

FIG. 3

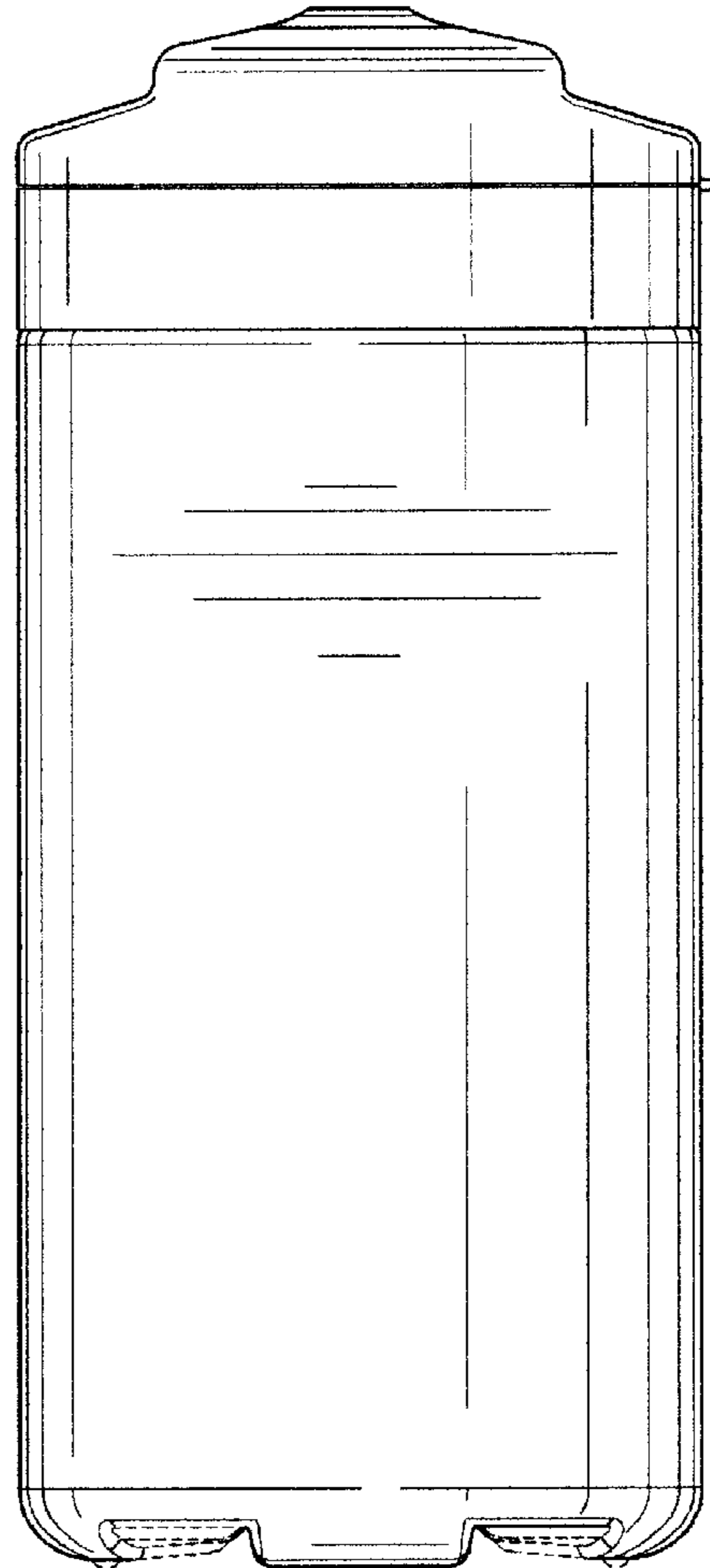

FIG. 4

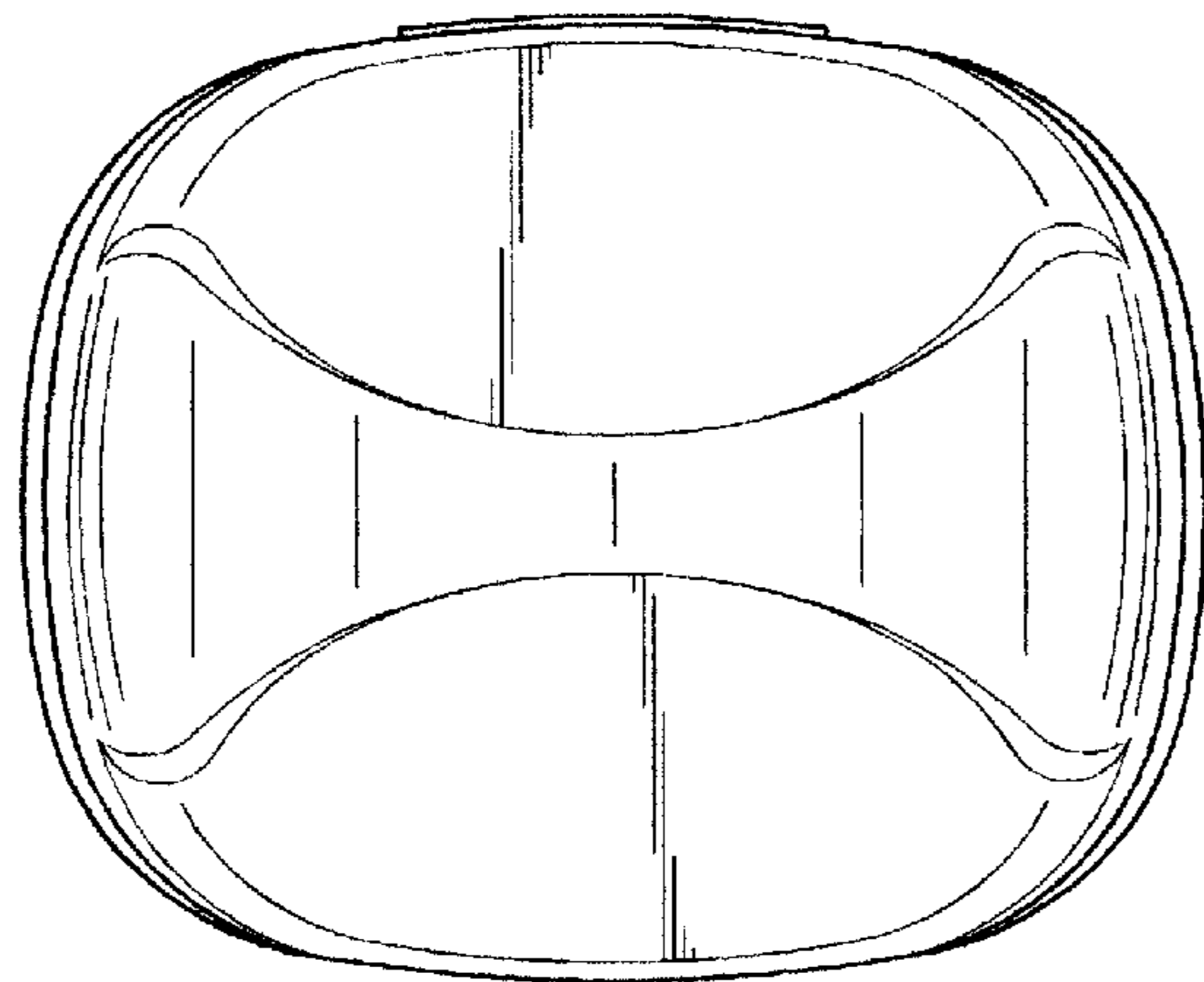

FIG. 5

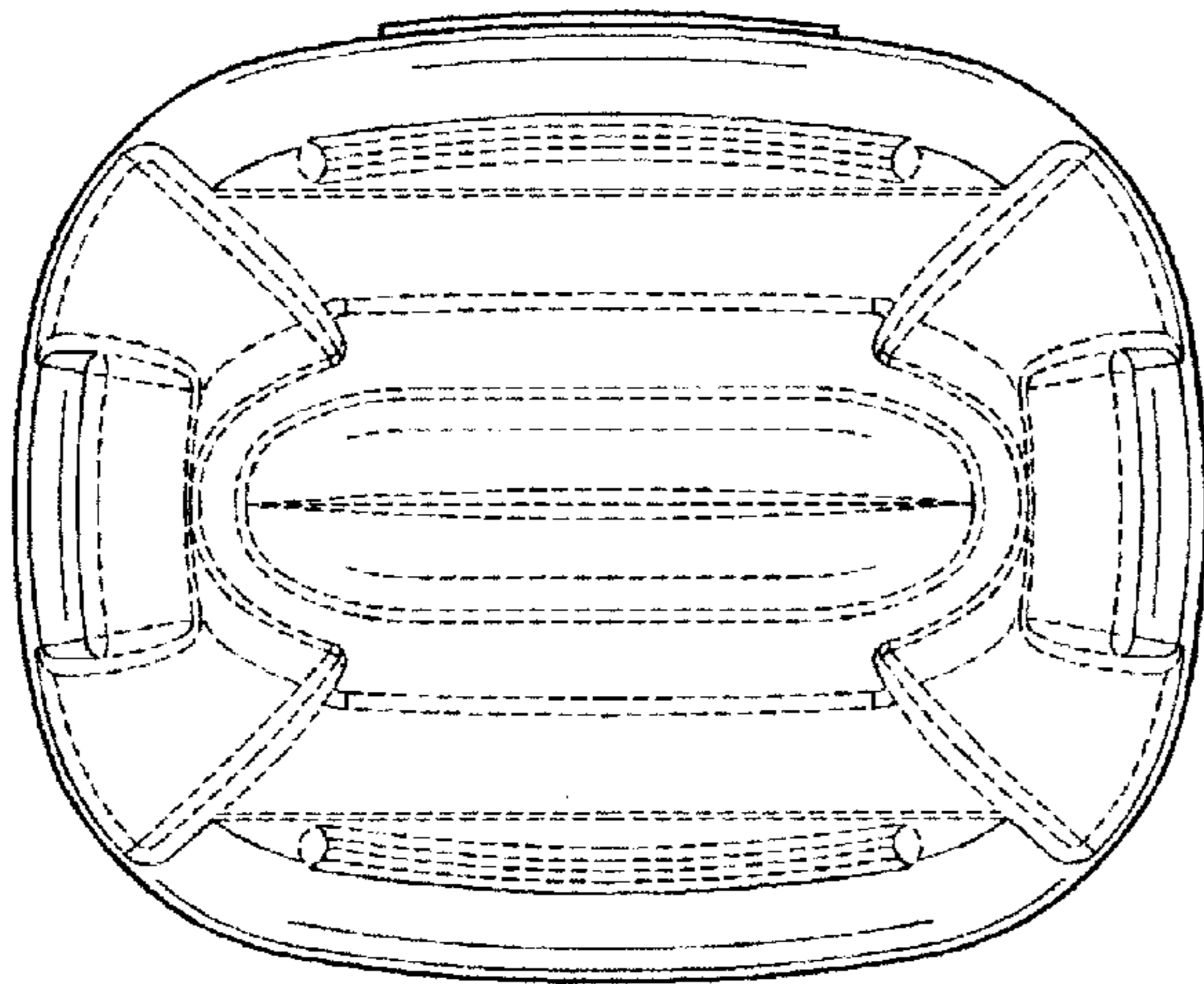

FIG. 6

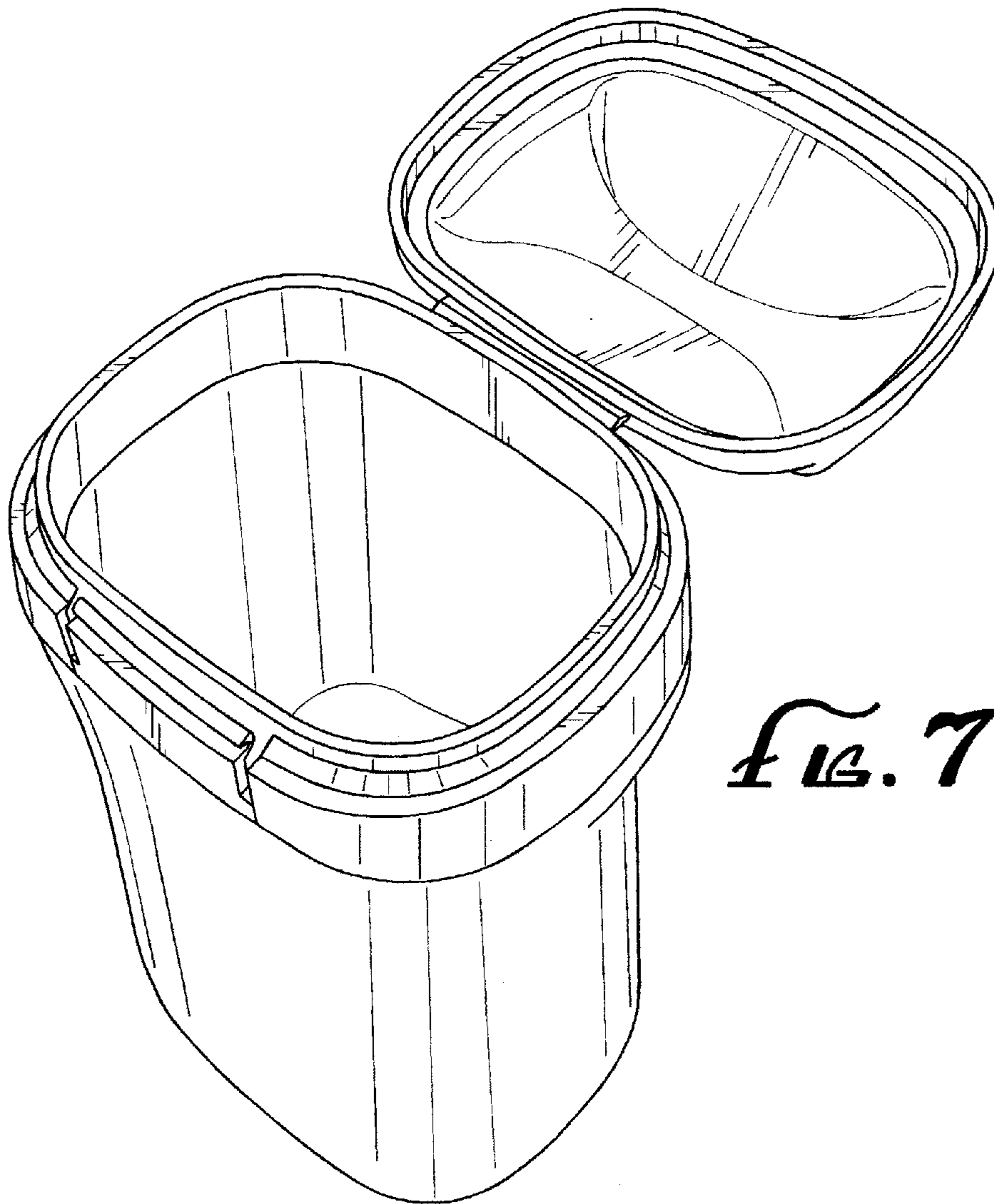

FIG. 7