

US00D504307S

(12) **United States Design Patent**  
**Dayan**

(10) **Patent No.:** **US D504,307 S**  
(45) **Date of Patent:** **\*\* Apr. 26, 2005**

- (54) **NOTCHED CABLE SPOOL STOP**
- (75) **Inventor:** **Mervin A. Dayan**, Oakhurst, NJ (US)
- (73) **Assignee:** **Intellectual Solutions, Inc.**, Eatontown, NJ (US)
- (\*\*) **Term:** **14 Years**
- (21) **Appl. No.:** **29/207,688**
- (22) **Filed:** **Jun. 17, 2004**
- (51) **LOC (7) Cl.** ..... **08-05**
- (52) **U.S. Cl.** ..... **D8/358; D3/24**
- (58) **Field of Search** ..... **D8/358, 359, 356; D22/140, 137; D15/138, 78; D14/484; D12/206; D3/24; 242/613, 476.6, 159, 118.7, 614.1; 206/412; 137/355.27; 254/213**

- D314,909 S \* 2/1991 Schmidt ..... D8/358
- D314,910 S \* 2/1991 VanSkiver ..... D8/359
- D334,882 S \* 4/1993 Bunch ..... D8/359
- 5,238,201 A \* 8/1993 Jonushaitis ..... 242/396.8
- D358,931 S \* 6/1995 Vanhuyse ..... D3/24
- D359,440 S \* 6/1995 Stewart ..... D8/359
- D393,409 S \* 4/1998 Azzarello ..... D8/356
- 5,806,788 A \* 9/1998 Witwer et al. .... 242/608.6
- 5,967,455 A \* 10/1999 Farber ..... 242/613
- 6,045,087 A \* 4/2000 Vislocky et al. .... 242/608.6
- 6,102,327 A \* 8/2000 Ripplinger ..... 242/609.1
- D436,021 S \* 1/2001 Arnold ..... D8/358
- D441,772 S \* 5/2001 Polzer ..... D15/138
- 2001/0038056 A1 \* 11/2001 Kimura ..... 242/476.6

\* cited by examiner

*Primary Examiner*—Jeffrey Asch  
*Assistant Examiner*—Austin Murphy  
(74) *Attorney, Agent, or Firm*—Robert F. Zielinski, Esq.; Richard C. Weinblatt, Esq.; Wolf, Block, Schorr and Sulis-Cohen LLP

(56) **References Cited**

**U.S. PATENT DOCUMENTS**

- 503,227 A \* 8/1893 Benham ..... 242/608.4
- D79,201 S \* 8/1929 Mills ..... D8/358
- 1,731,219 A \* 10/1929 Atwood ..... 242/118.8
- 2,490,042 A \* 12/1949 Frost ..... 242/131.1
- 2,828,090 A \* 3/1958 Steinback ..... 242/118.7
- 3,266,749 A \* 8/1966 Tripini et al. .... 242/118.7
- 3,620,471 A \* 11/1971 Hubbard et al. .... 242/118.6
- 3,693,906 A \* 9/1972 Robinson ..... 242/159
- 3,732,974 A \* 5/1973 Ram et al. .... 206/412
- D244,943 S \* 7/1977 Balmer, Jr. .... D14/484
- 4,072,278 A \* 2/1978 Petersen ..... 242/388.4
- 4,078,741 A \* 3/1978 Underwood ..... 242/608.6
- D247,667 S \* 4/1978 Balmer, Jr. .... D14/484
- 4,083,450 A \* 4/1978 La Mar ..... 206/416
- 4,126,211 A \* 11/1978 Blosser ..... 410/49
- D275,729 S \* 10/1984 Stoddard ..... D8/359
- D281,482 S \* 11/1985 Suzuki ..... D8/358

(57) **CLAIM**

The ornamental design for a notched cable spool stop, as shown and described.

**DESCRIPTION**

FIG. 1 is a perspective view of the notched cable spool stop. FIG. 2 is a top view of the notched cable spool stop. FIG. 3 is a bottom view of the notched cable spool stop. FIG. 4 is a left side view of the notched cable spool stop. FIG. 5 is a right side view of the notched cable spool stop; and, FIG. 6 is a front view of the notched cable spool stop. The broken line showings in FIGS. 1 and 2 are for illustrative purposes and form no part of the claimed design.

**1 Claim, 4 Drawing Sheets**

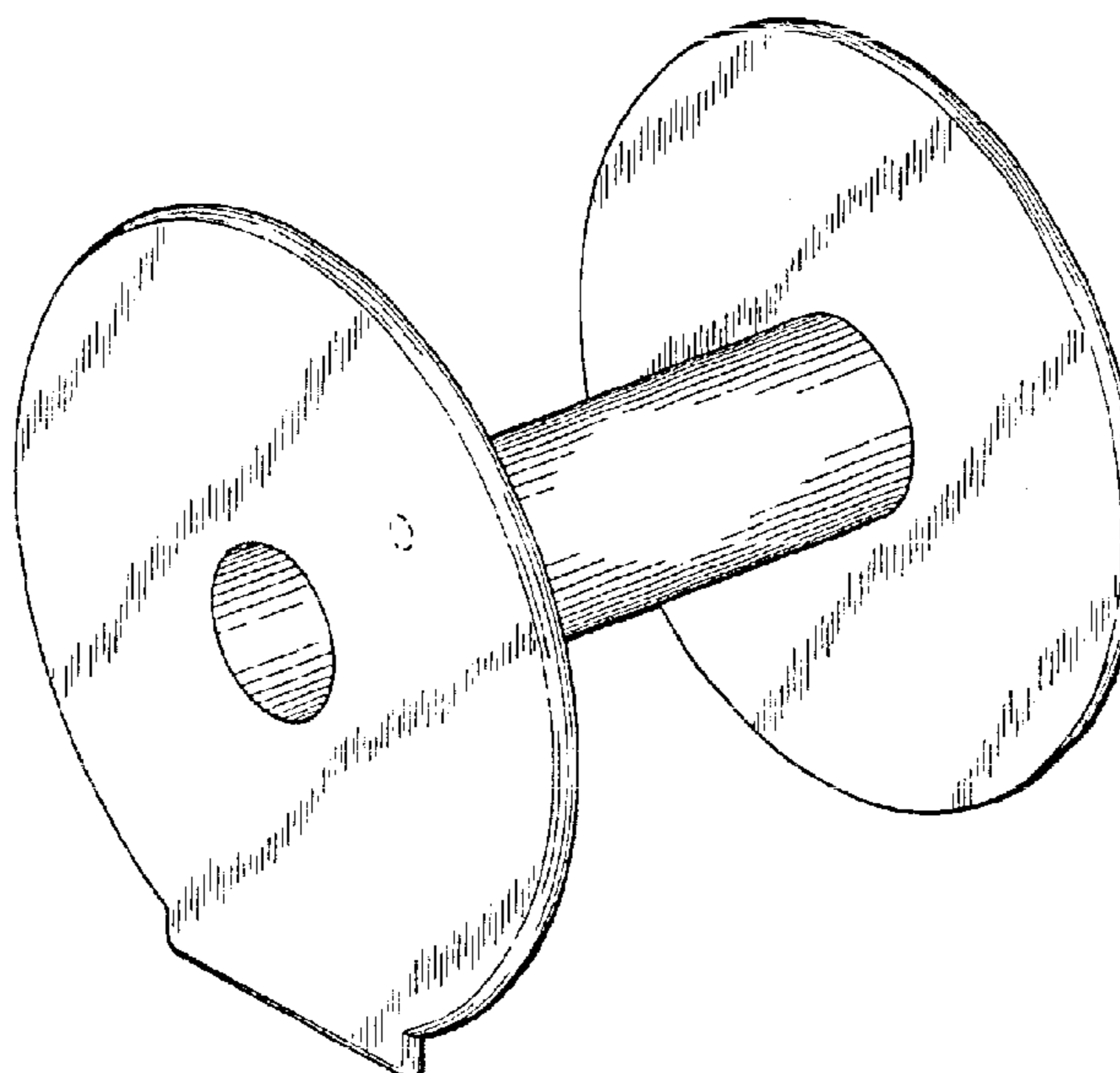

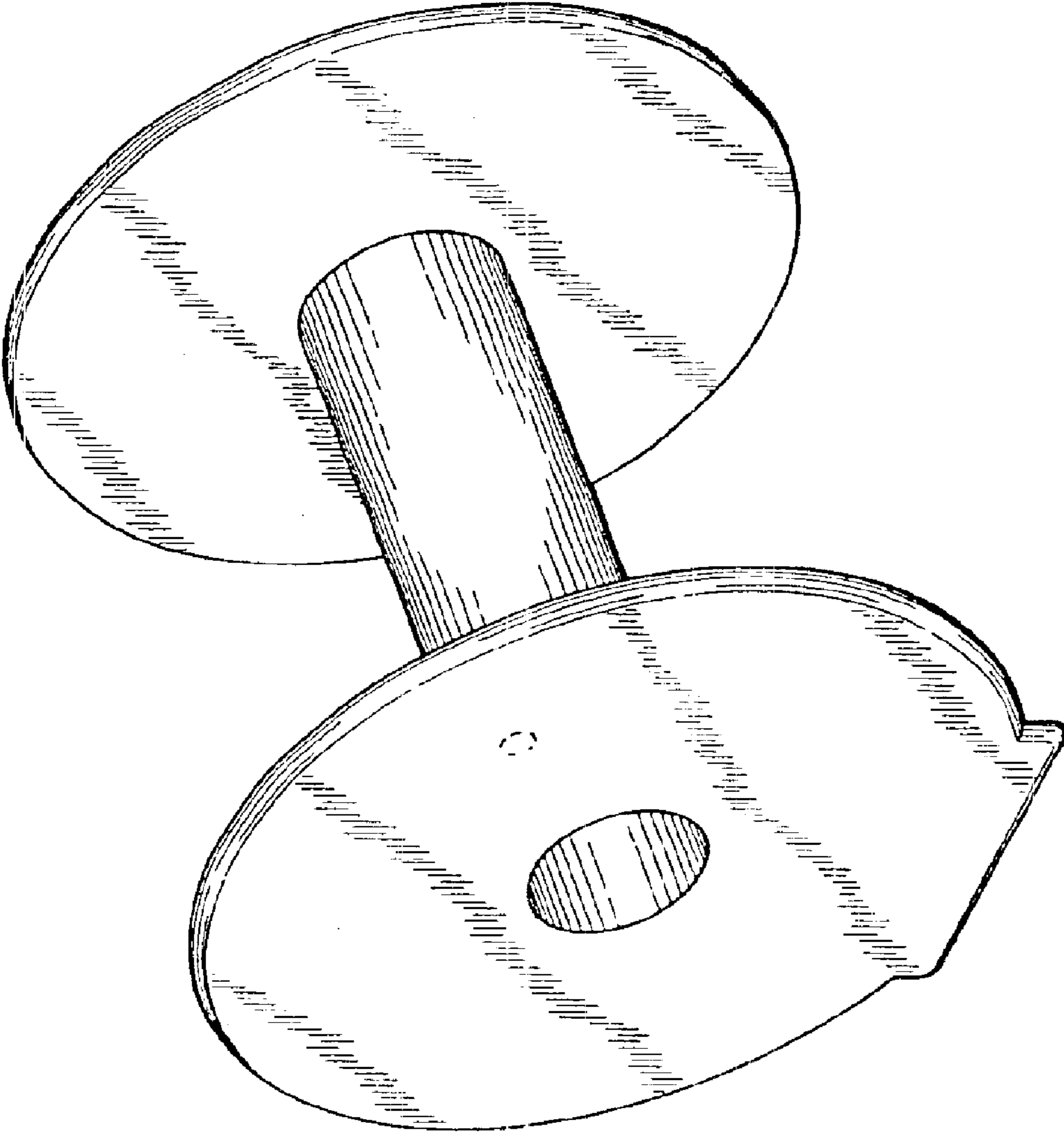

FIG. 1

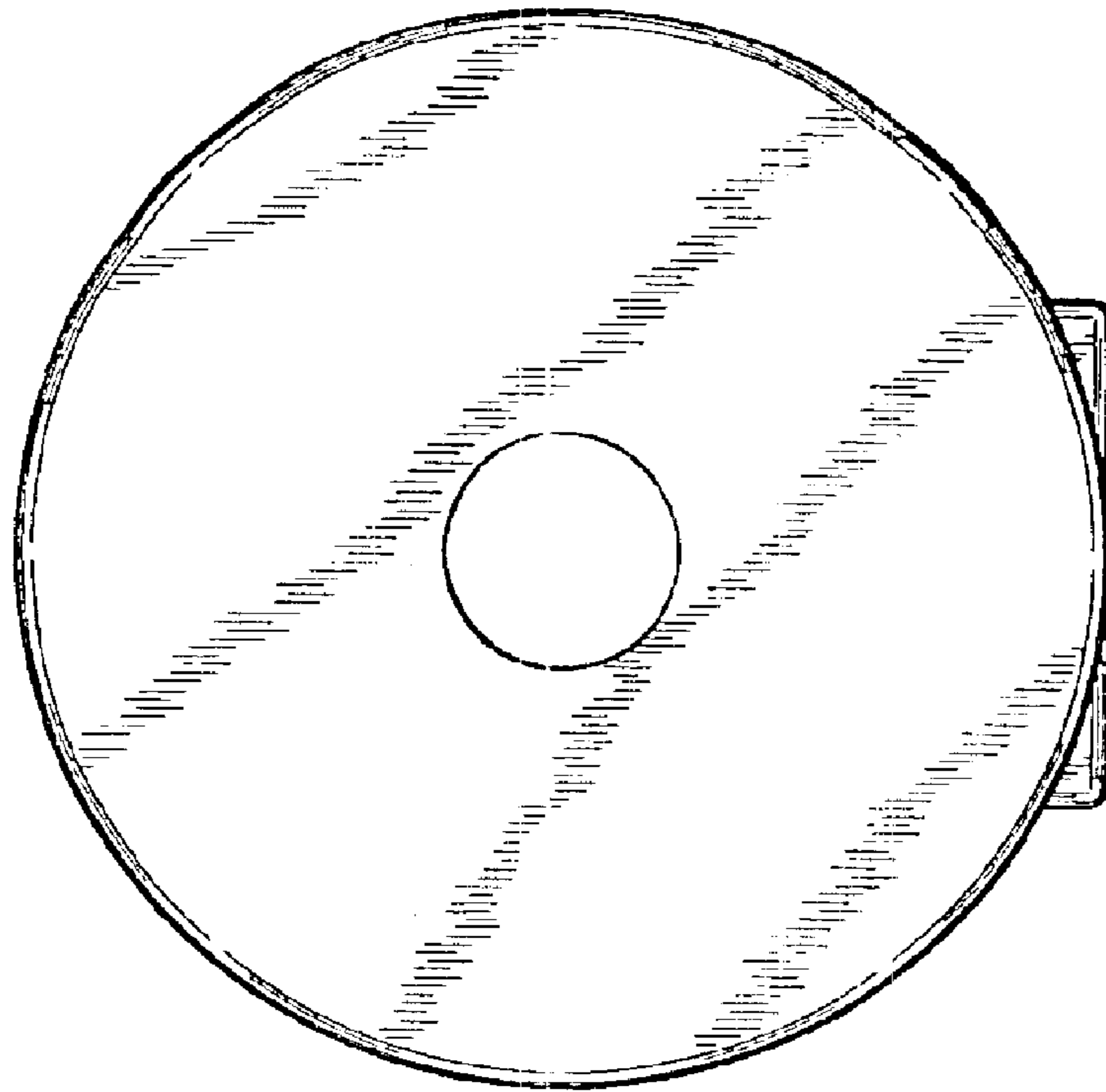

FIG.3

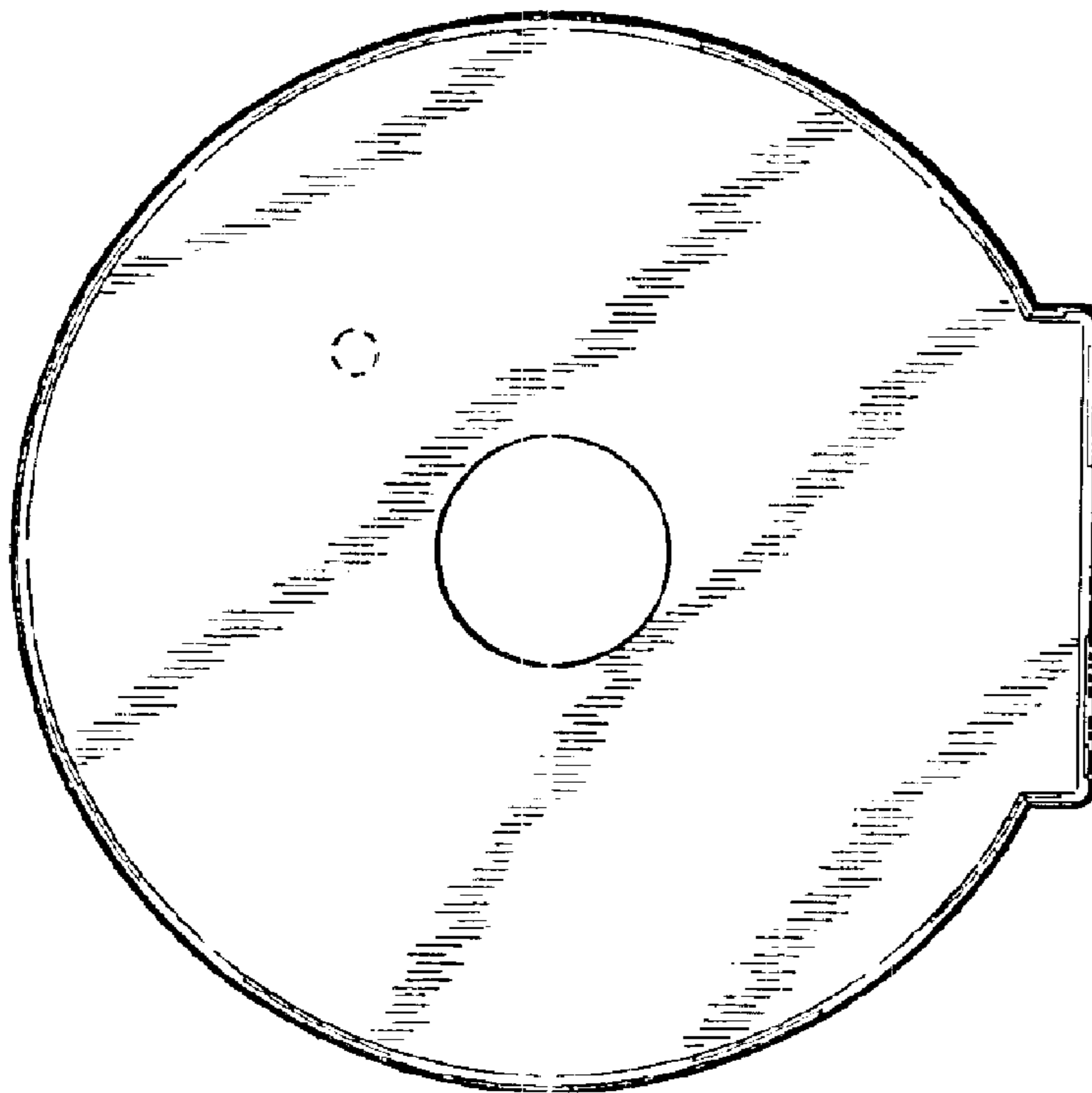

FIG.2

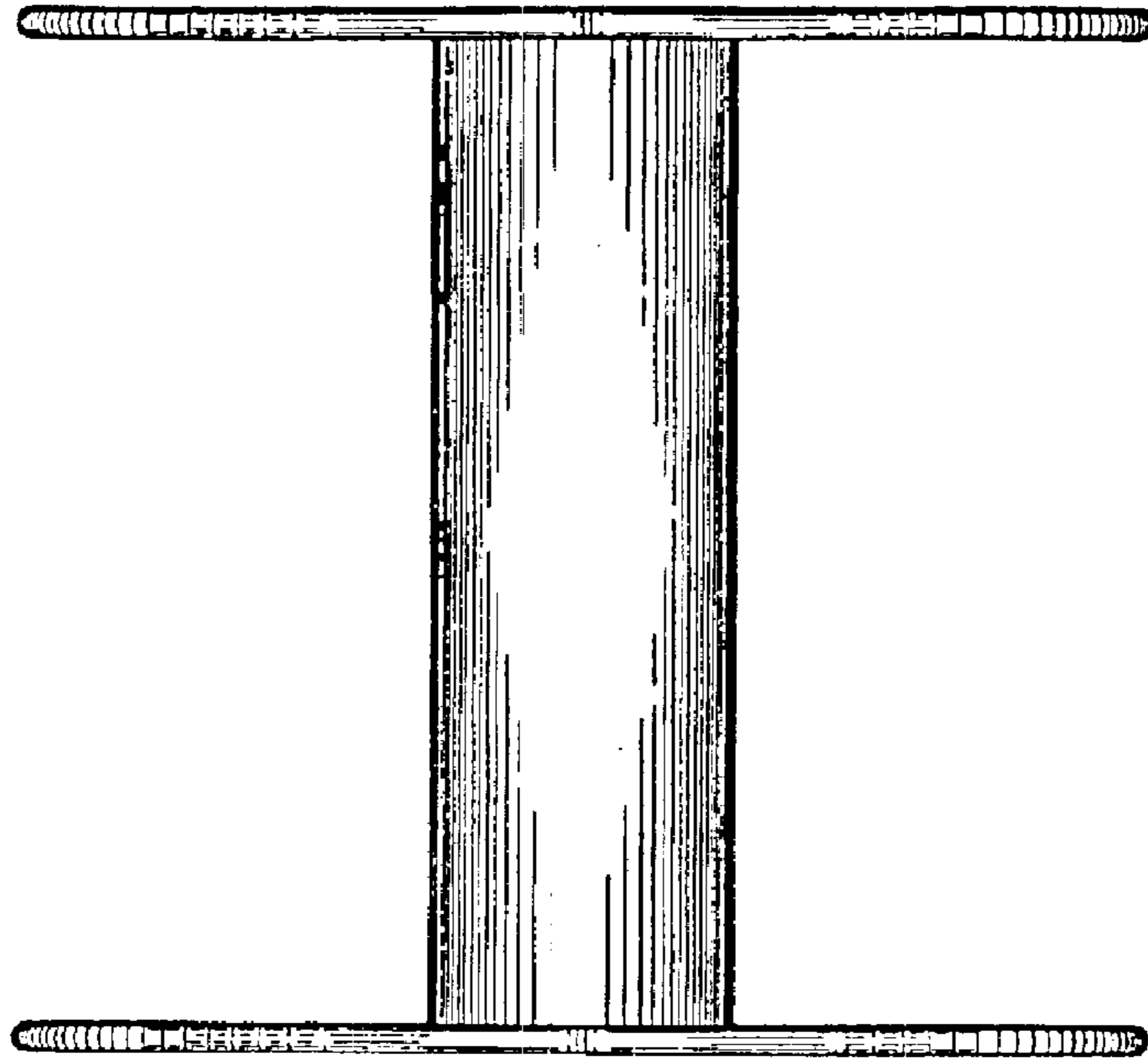

FIG.5

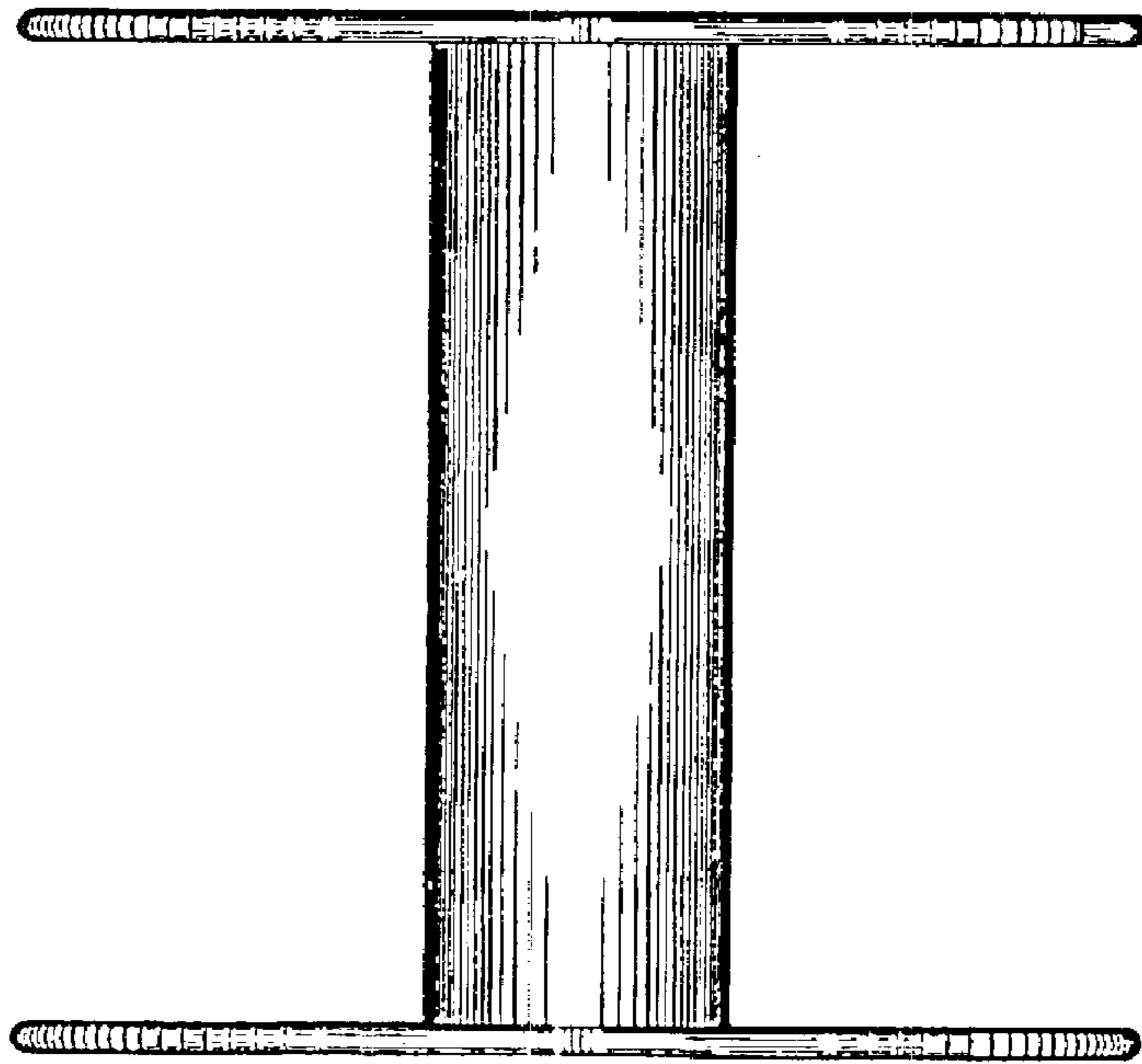

FIG.4

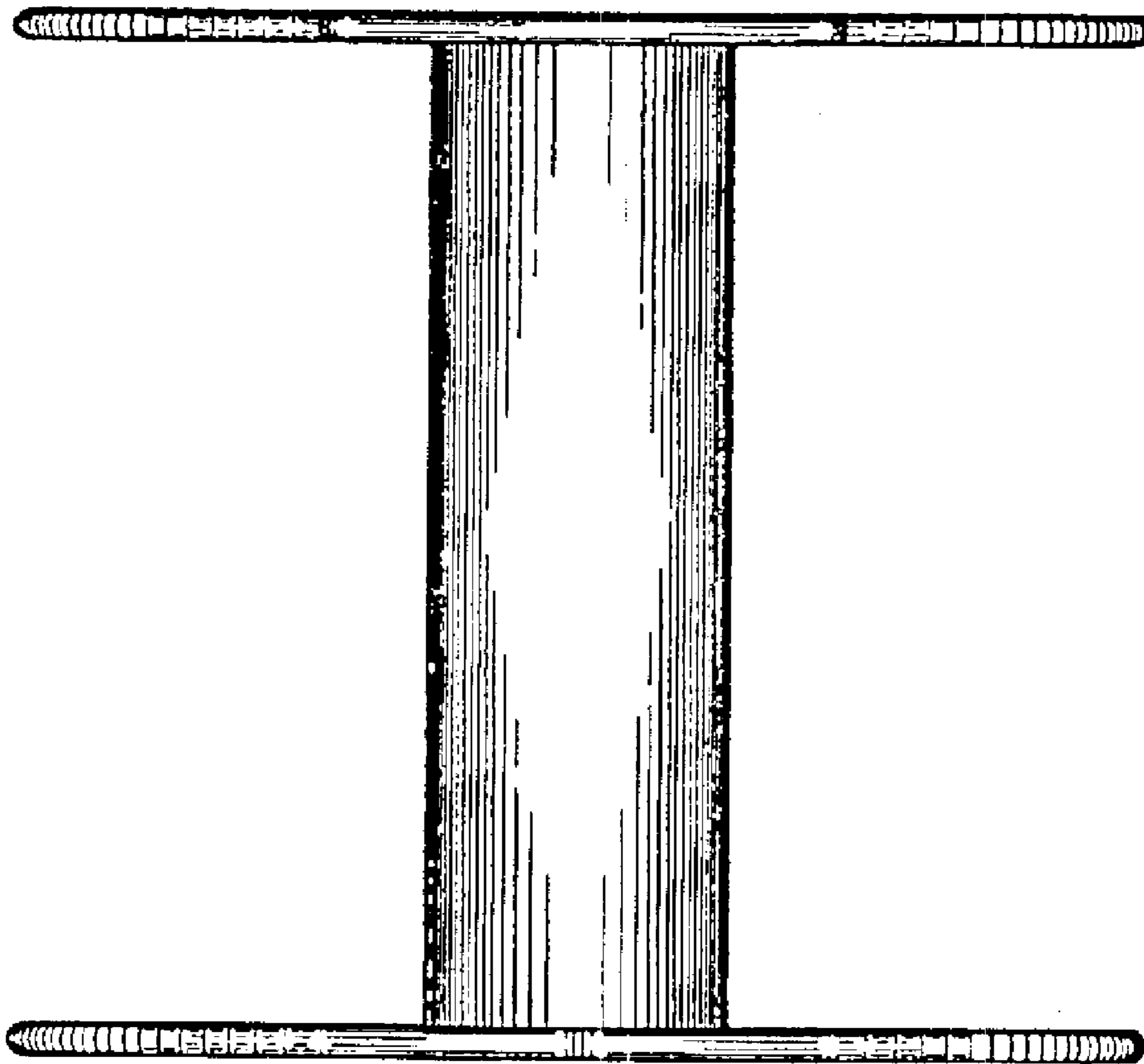

FIG. 6