

US00D504197S

(12) **United States Design Patent**  
**Huthmaker et al.**

(10) **Patent No.: US D504,197 S**  
(45) **Date of Patent: \*\* Apr. 19, 2005**

(54) **COMBINATION PET FOOD AND WATER DISH**

(75) Inventors: **Todd Huthmaker**, Wooster, OH (US);  
**Chris Beilstein**, Wooster, OH (US)

(73) Assignee: **Rubbermaid, Incorporated**, Wooster, OH (US)

(\*\*) Term: **14 Years**

(21) Appl. No.: **29/194,853**

(22) Filed: **Dec. 2, 2003**

(51) **LOC (7) Cl. .... 30-03**

(52) **U.S. Cl. .... D30/129**

(58) **Field of Search** ..... D30/121, 128,  
D30/129, 132; 119/51.5, 57.5, 61.5, 61.54-61.55;  
D7/553.4-553.8, 546

(56) **References Cited**

**U.S. PATENT DOCUMENTS**

4,357,905	A	*	11/1982	Carpenter	.....	119/61.53
4,658,759	A		4/1987	Brown		
4,976,223	A		12/1990	Pierce		
5,560,316	A	*	10/1996	Lillelund	.....	119/61.5
5,752,464	A	*	5/1998	King et al.	.....	119/63
5,975,016	A		11/1999	Wesenhagen		
5,979,361	A		11/1999	Willinger		
6,142,101	A		11/2000	Pelsor		
6,145,474	A		11/2000	Lemkin		
6,209,487	B1		4/2001	Quinlan et al.		

**OTHER PUBLICATIONS**

Richell USA Inc. Corporate Website MP Bowl, <https://www.richellusa.com/product/pet/mpbowl.html>, printed Feb. 27, 2004.

\* cited by examiner

*Primary Examiner*—Alan P. Douglas

*Assistant Examiner*—Susan M Lee

(74) *Attorney, Agent, or Firm*—Marshall, Gerstein & Borun LLP

(57) **CLAIM**

The ornamental design for a “combination pet food and water dish”, as shown and described.

**DESCRIPTION**

FIG. 1 is a perspective view taken from the front, side and above showing a first embodiment of our new design;

FIG. 2 is a front elevational view thereof;

FIG. 3 is a rear elevational view thereof;

FIG. 4 is a top plan view thereof;

FIG. 5 is a bottom plan view thereof;

FIG. 6 is a left elevational view thereof;

FIG. 7 is a right elevational view thereof;

FIG. 8 is a perspective view taken from the front, side and above showing a second embodiment of our new design;

FIG. 9 is a front elevational view thereof;

FIG. 10 is a rear elevational view thereof;

FIG. 11 is a top plan view thereof;

FIG. 12 is a bottom plan view thereof;

FIG. 13 is a left elevational view thereof; and,

FIG. 14 is a right elevational view thereof.

**1 Claim, 8 Drawing Sheets**

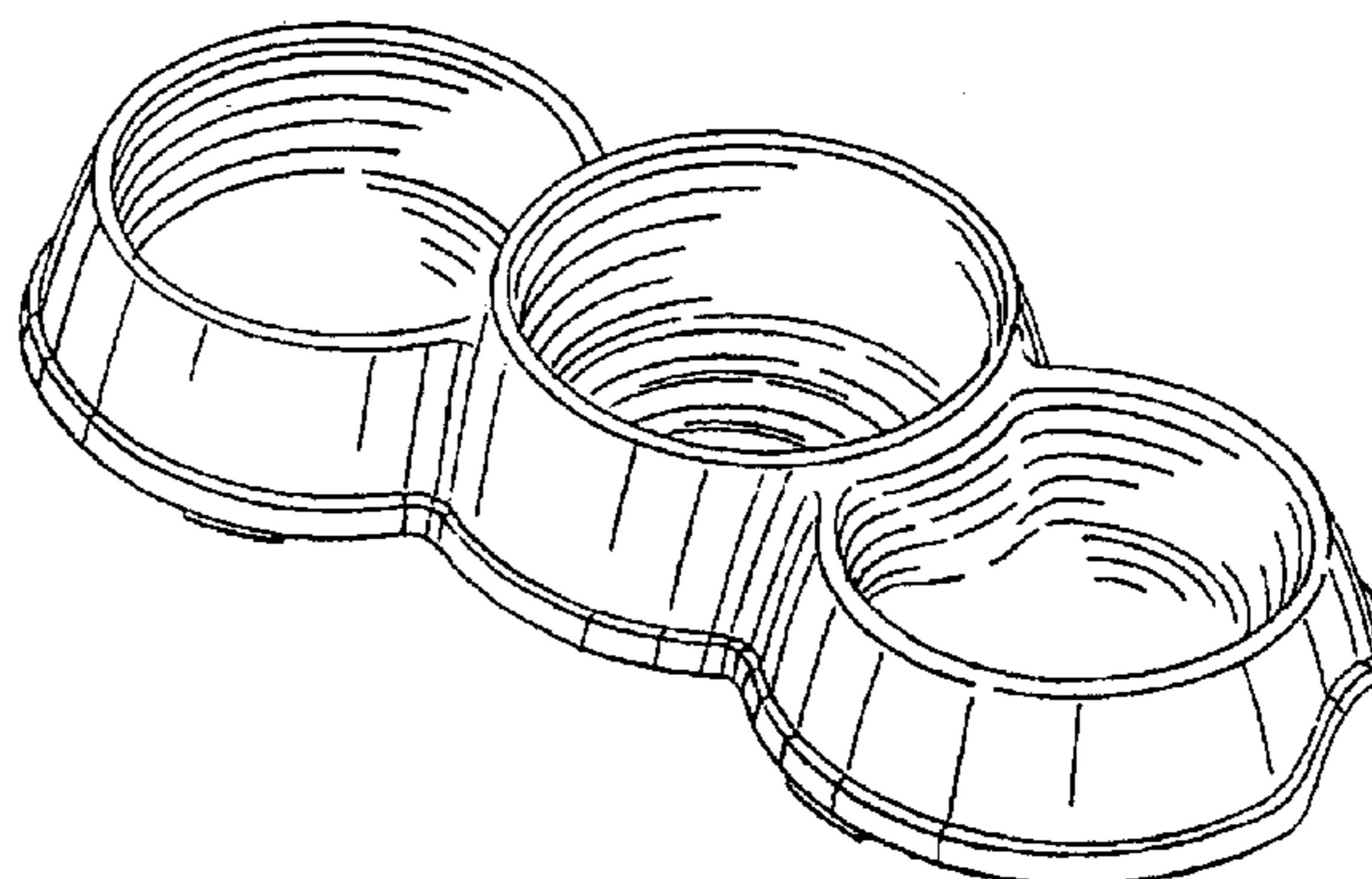
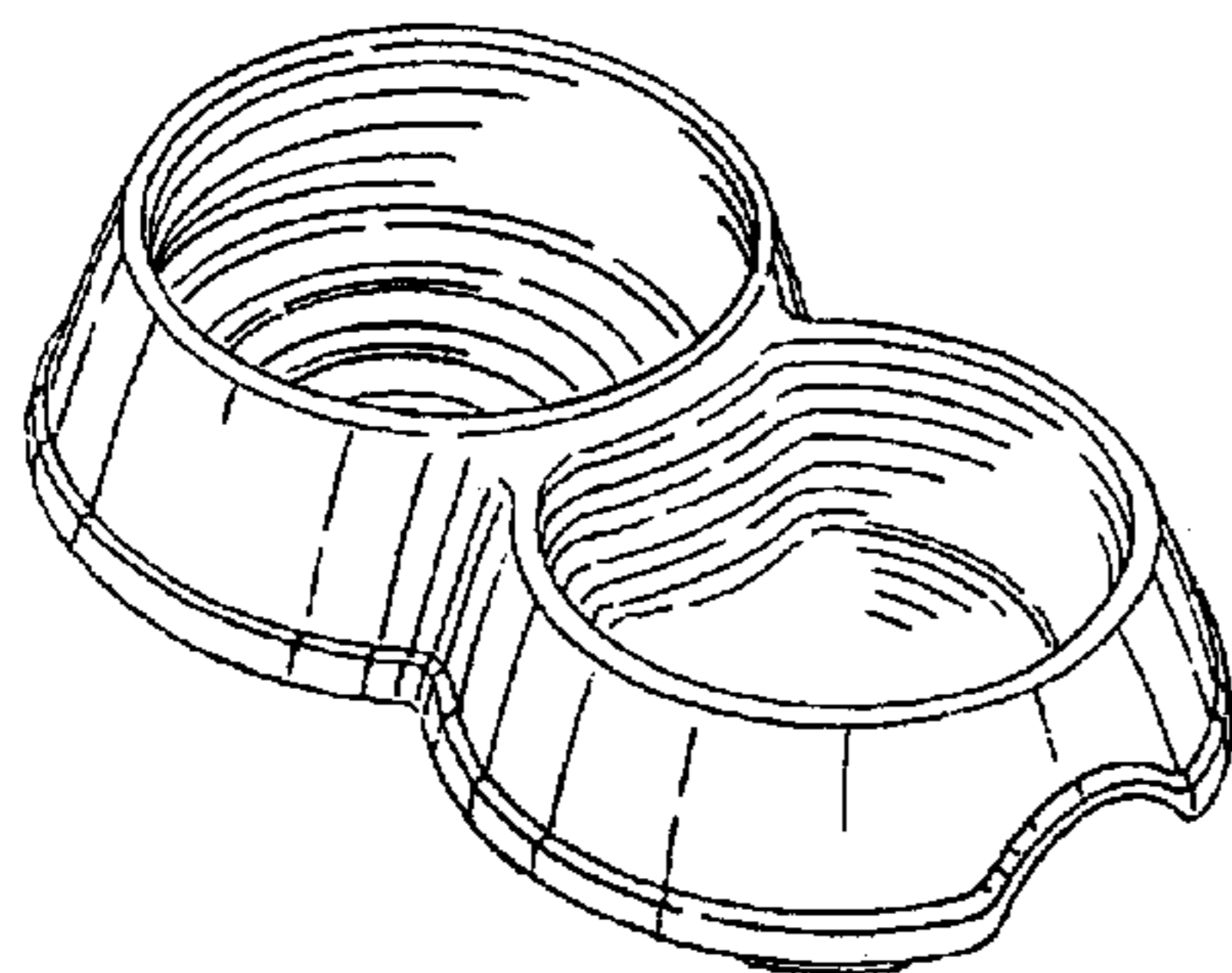

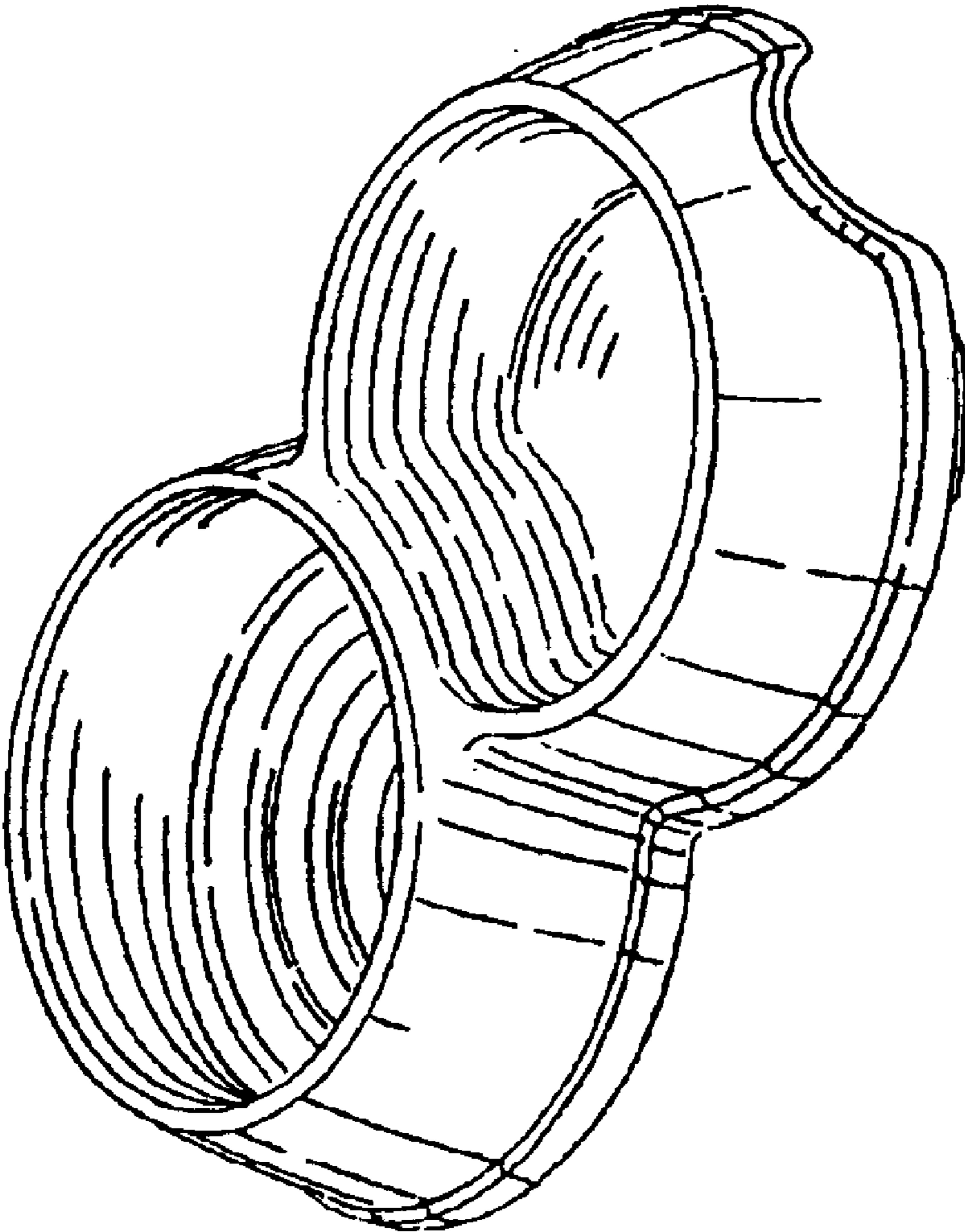

FIG. 1

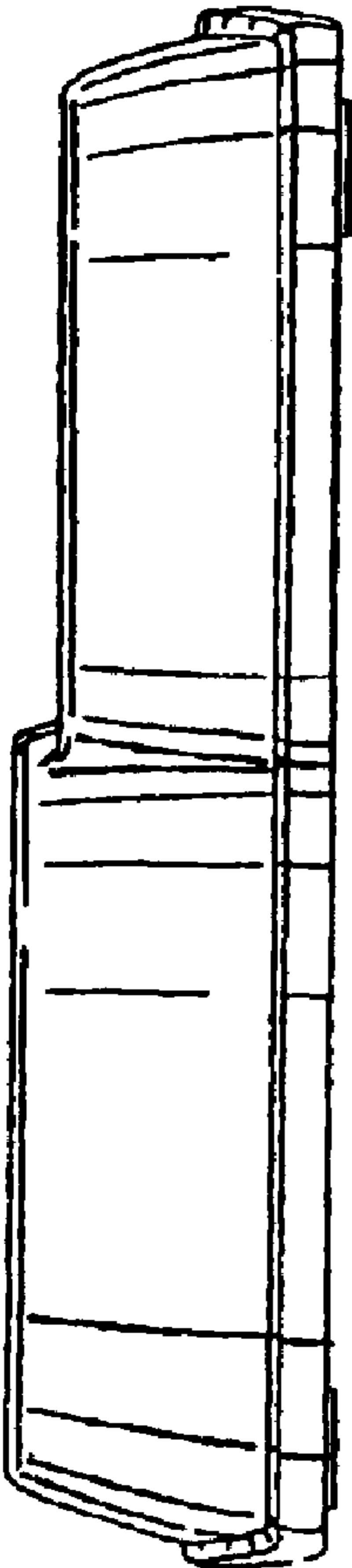

FIG. 2

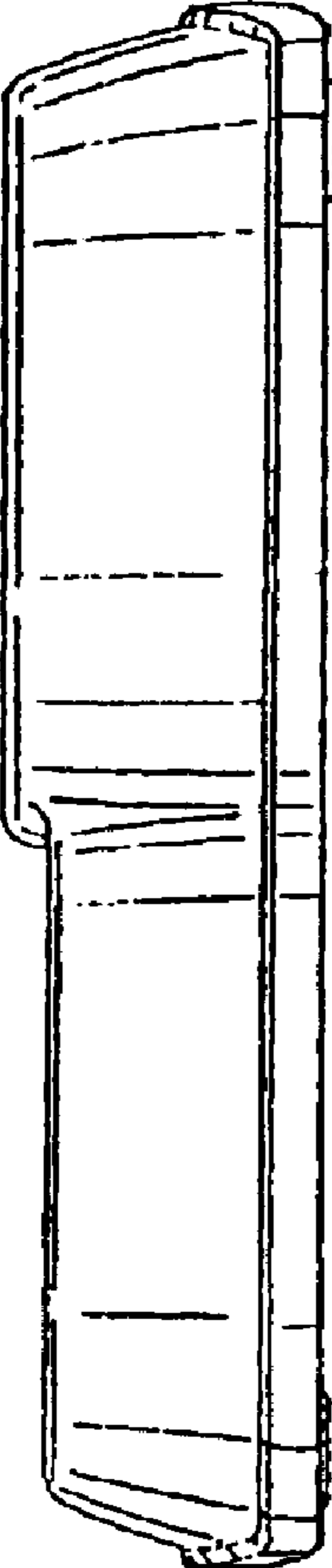

FIG. 3

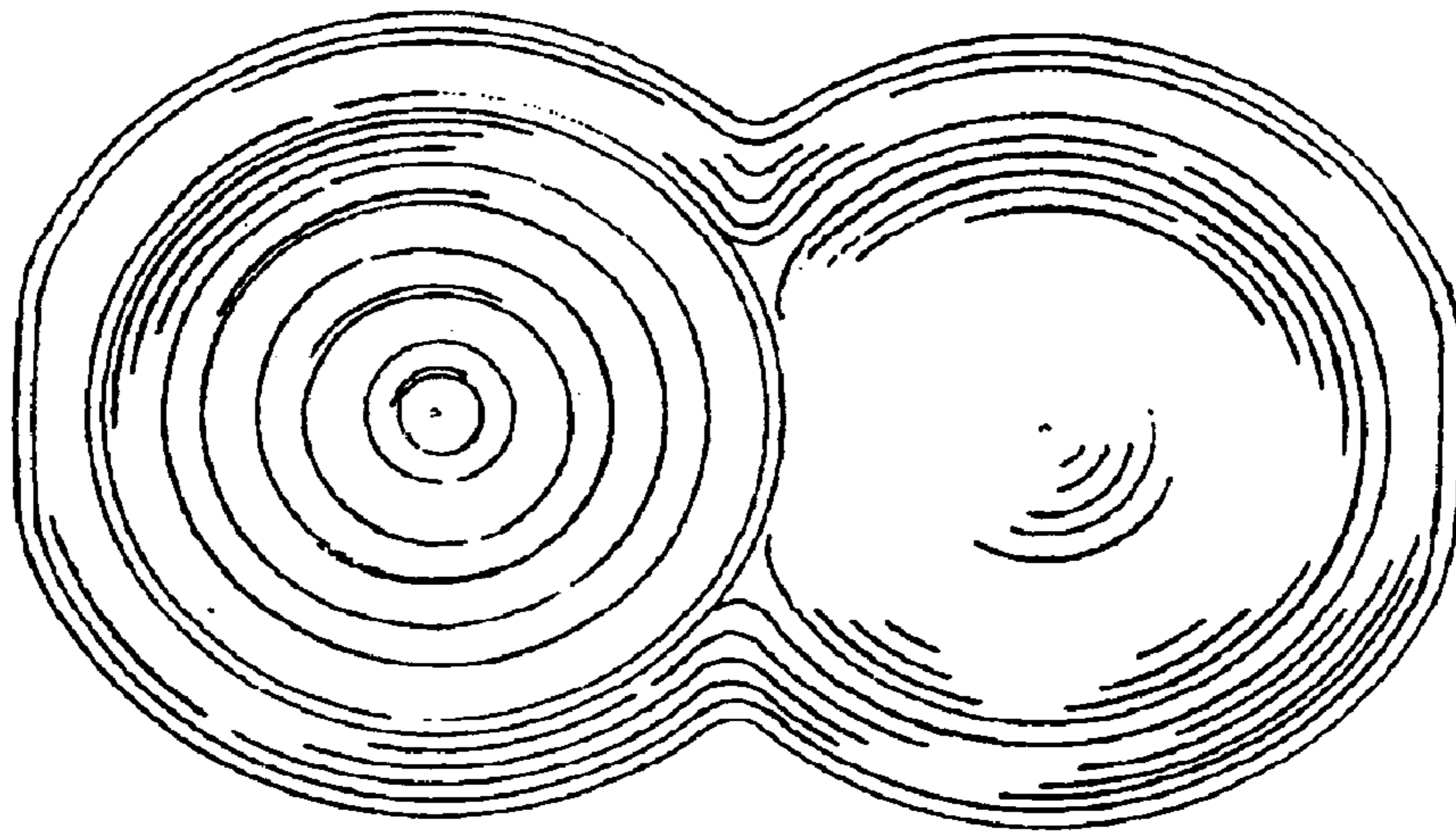

FIG. 4

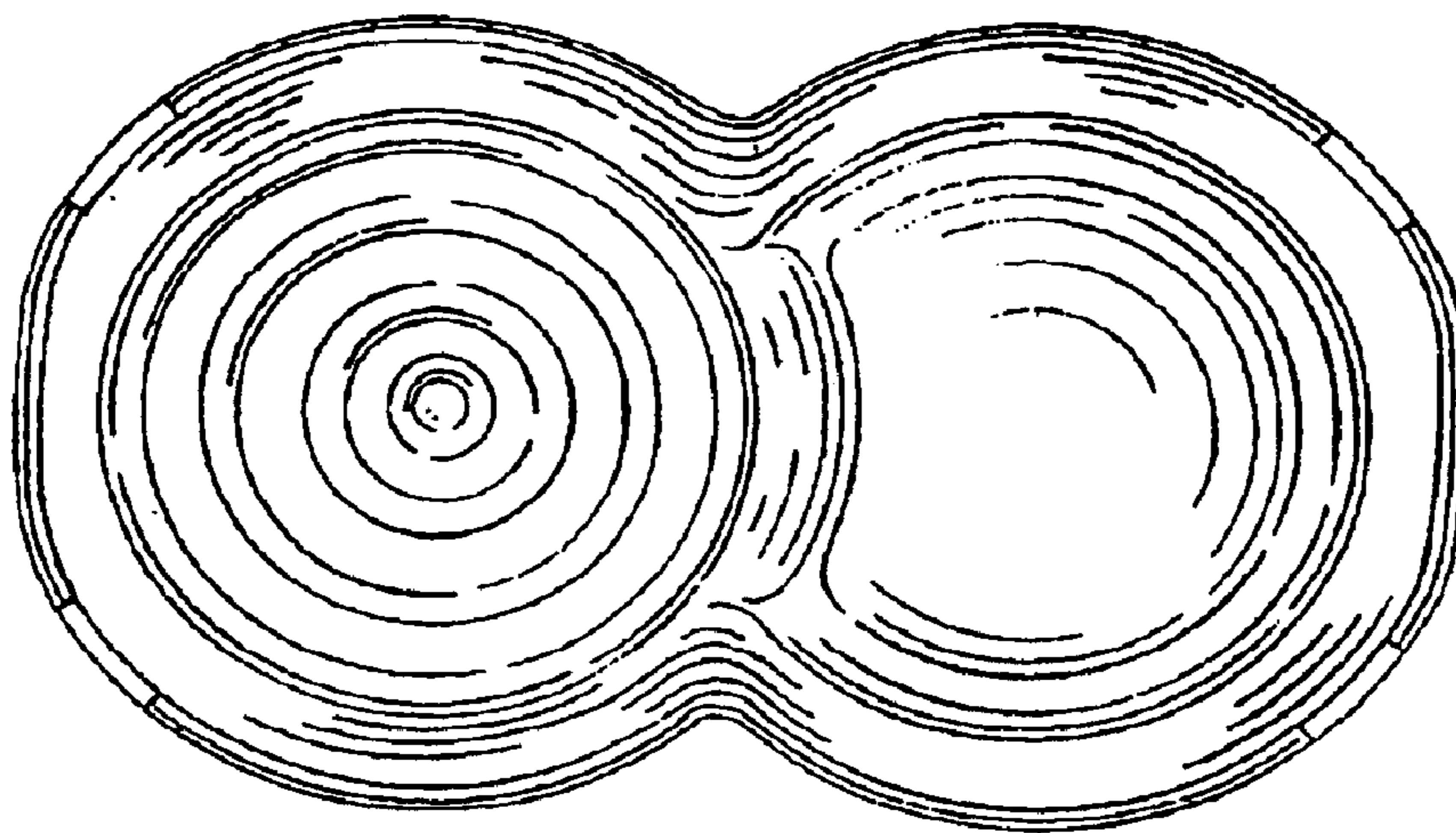

FIG. 5

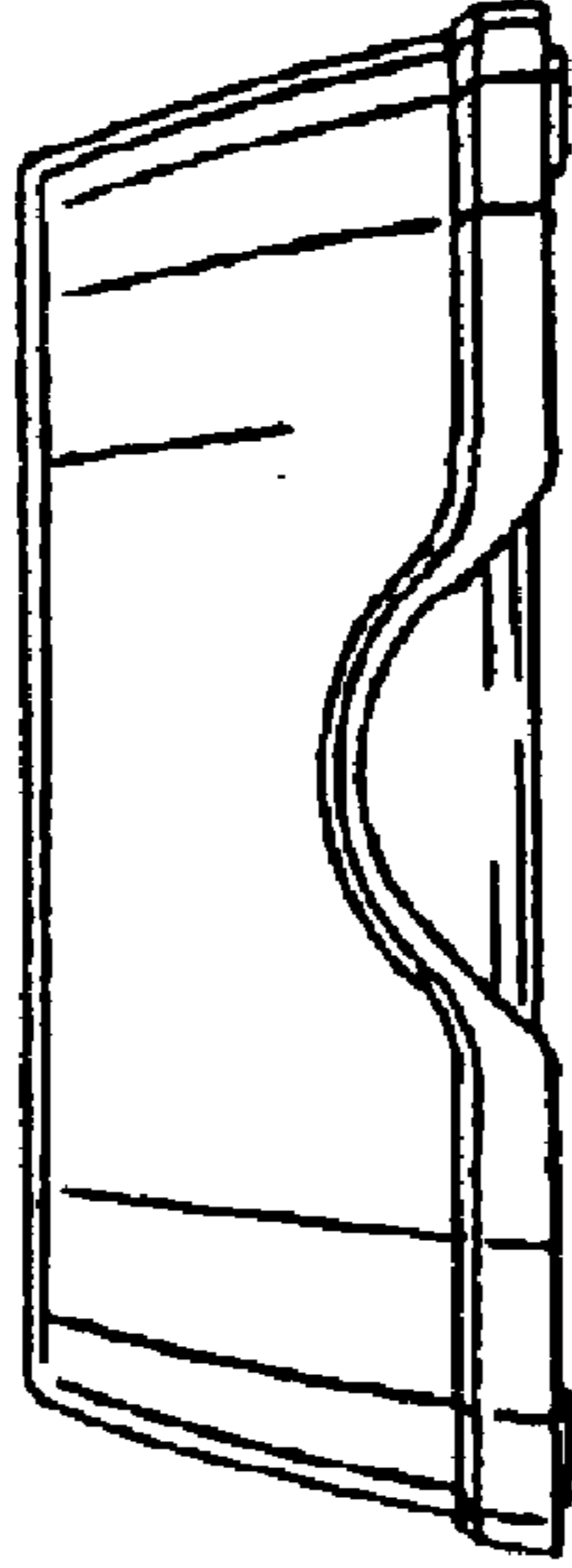

FIG. 7

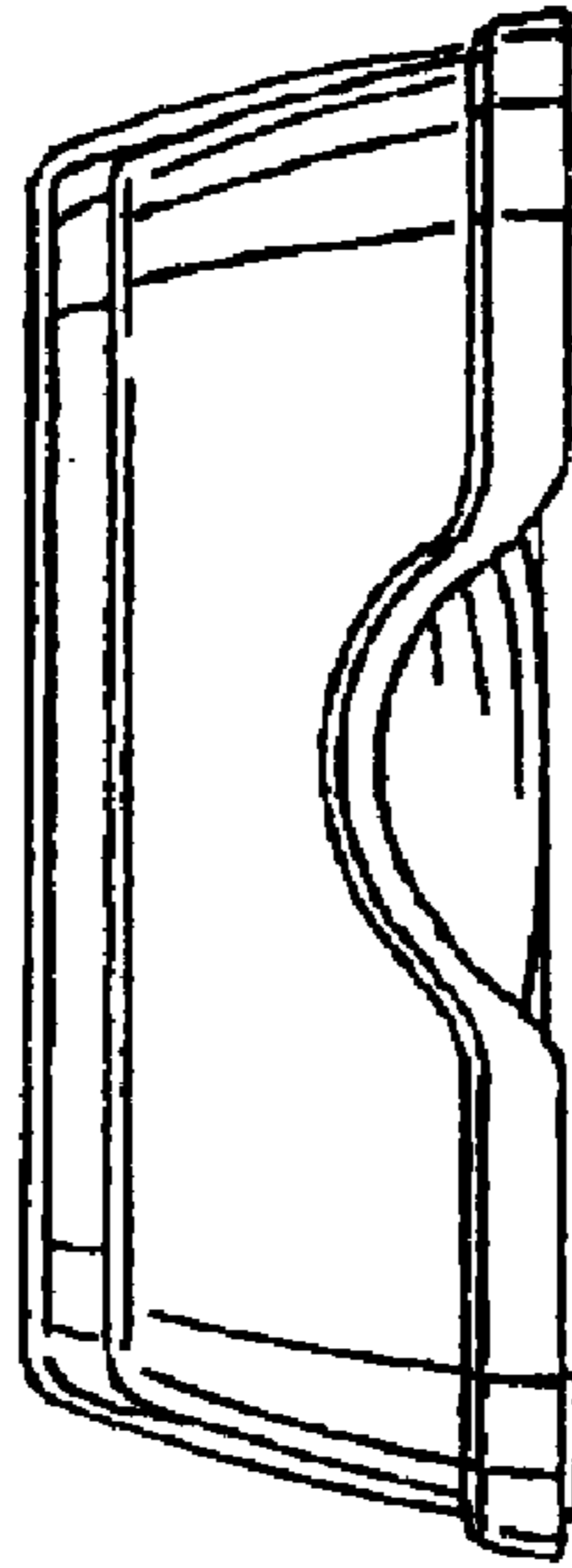

FIG. 6

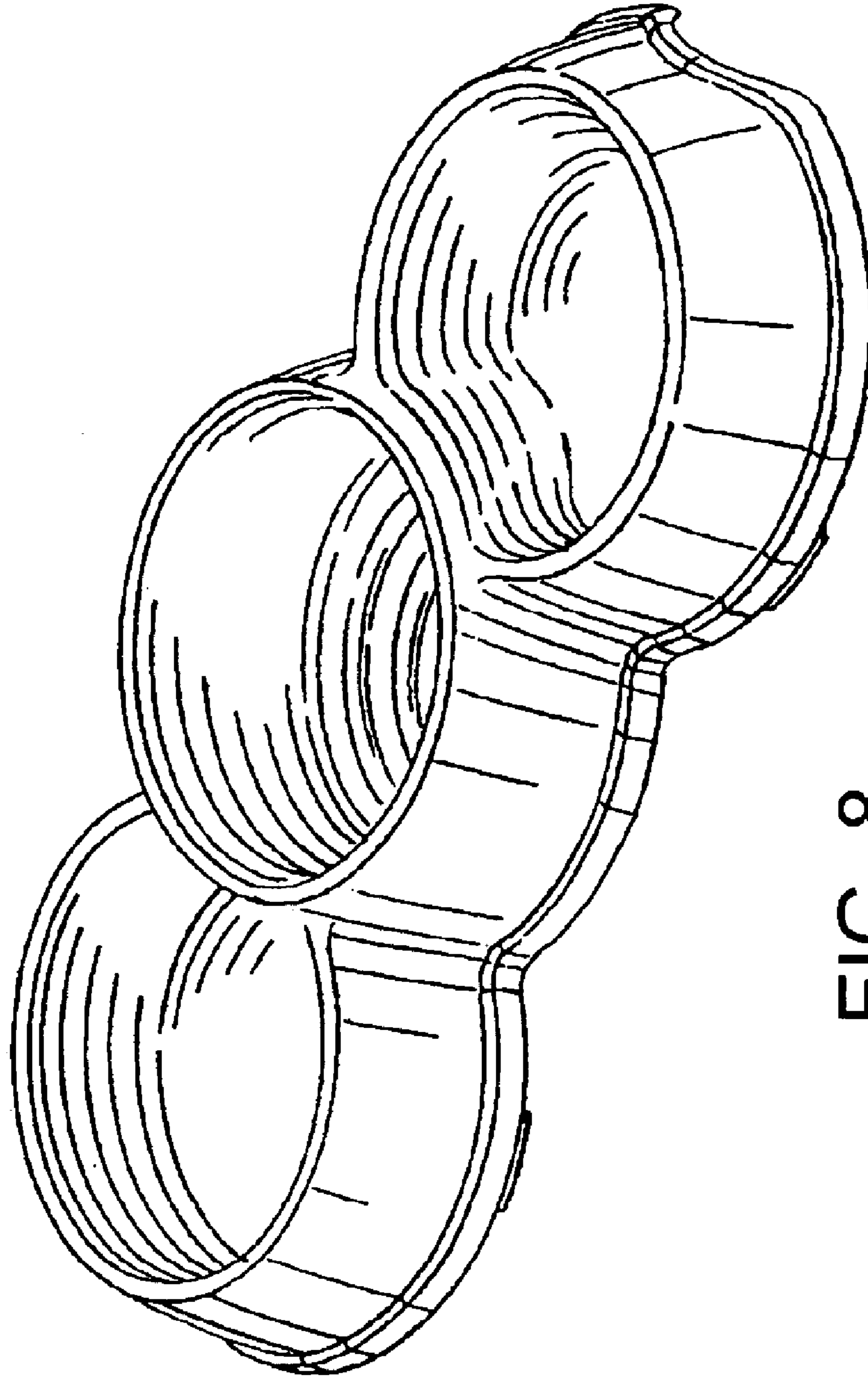

FIG. 8

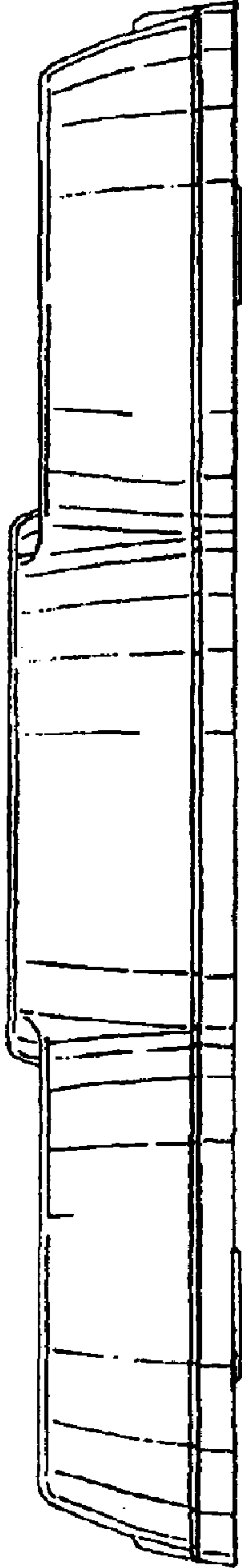

FIG. 9

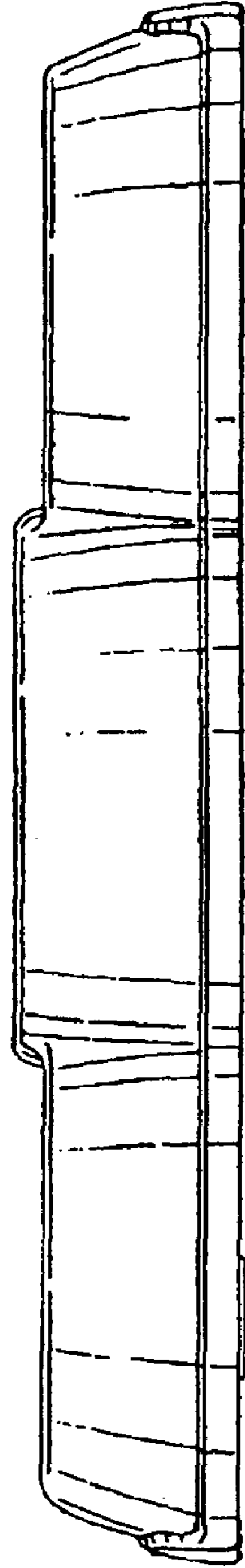

FIG. 10

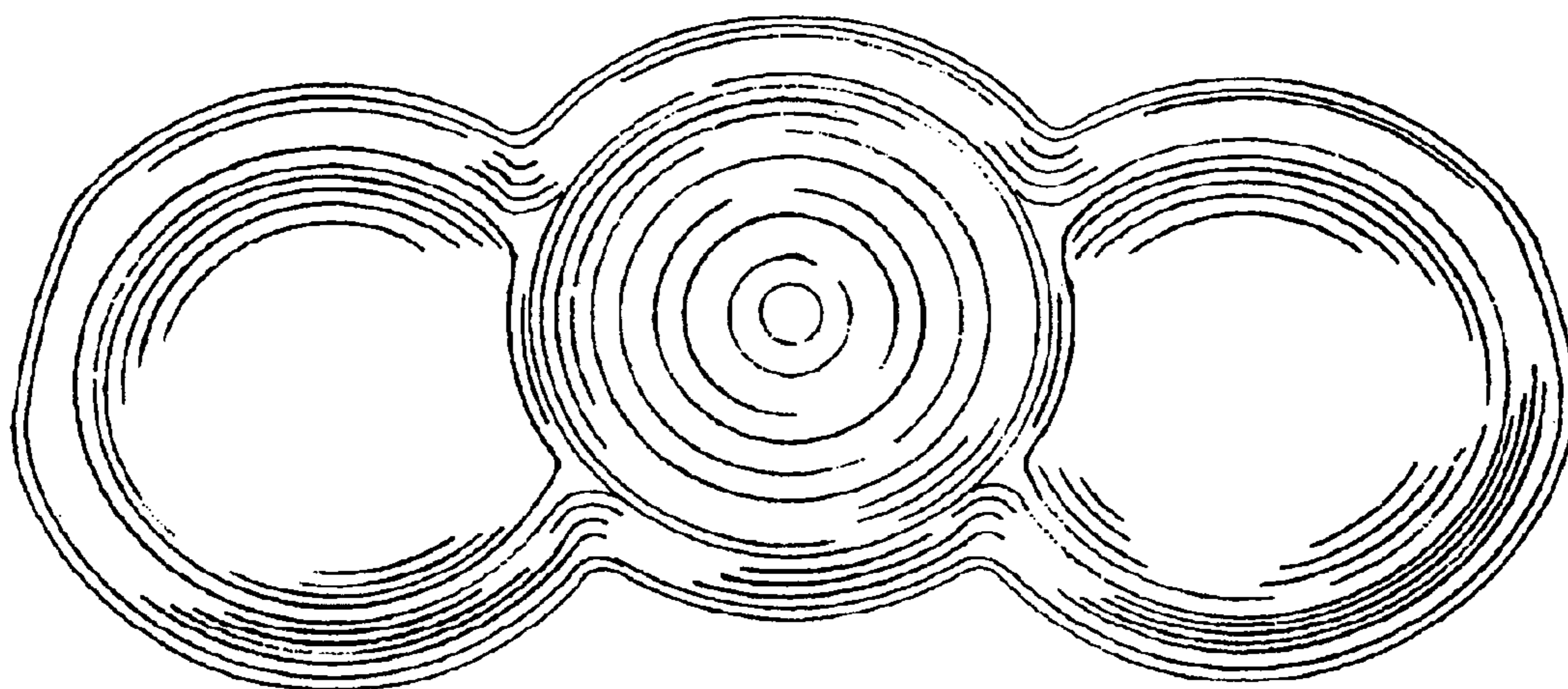

FIG. 11

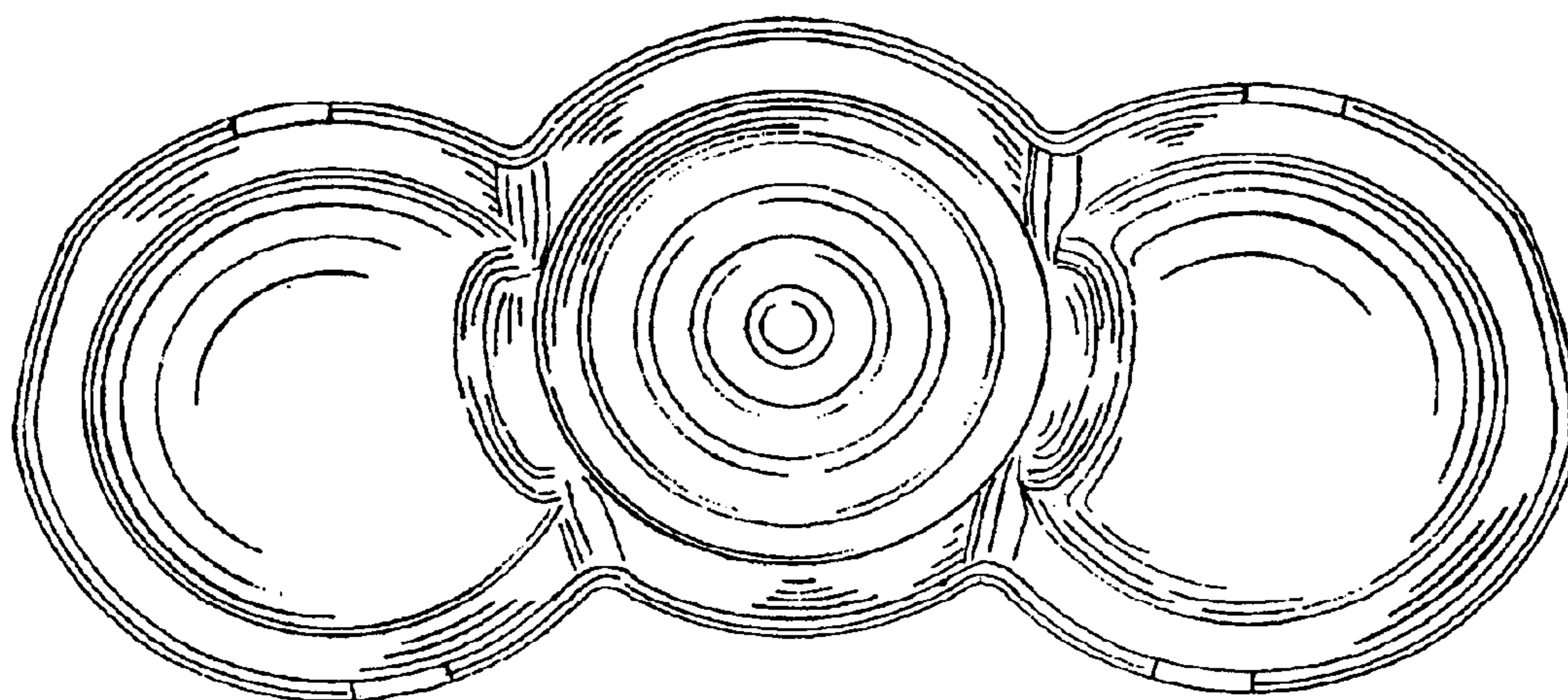

FIG. 12



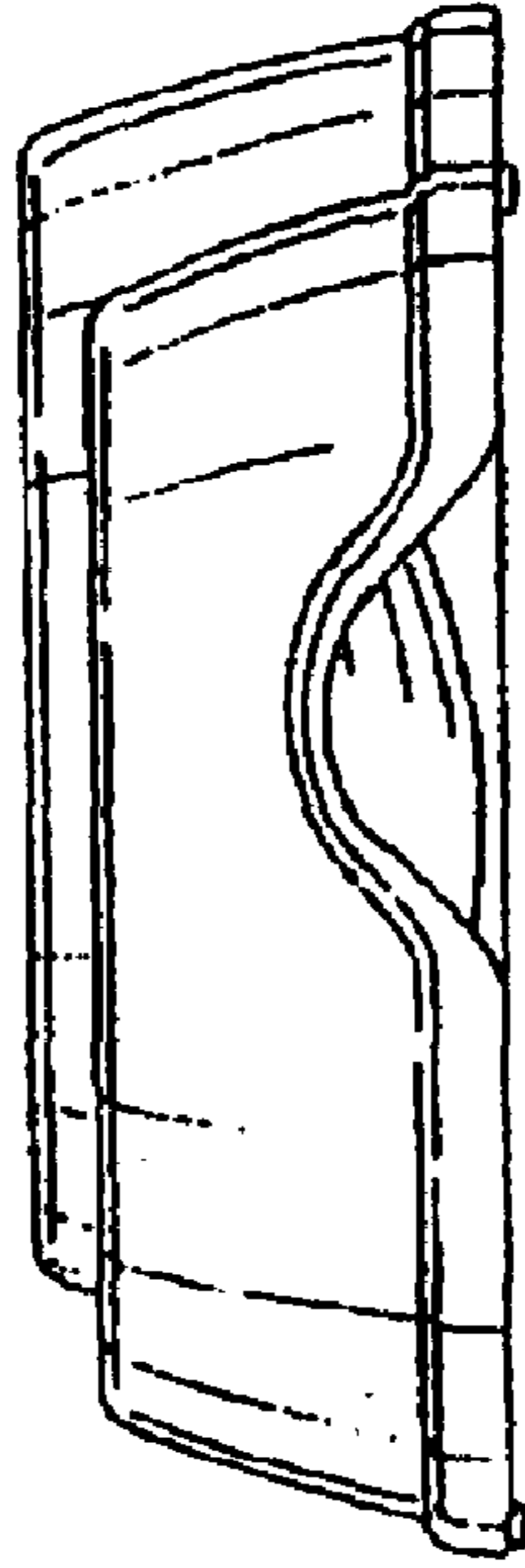

FIG. 14

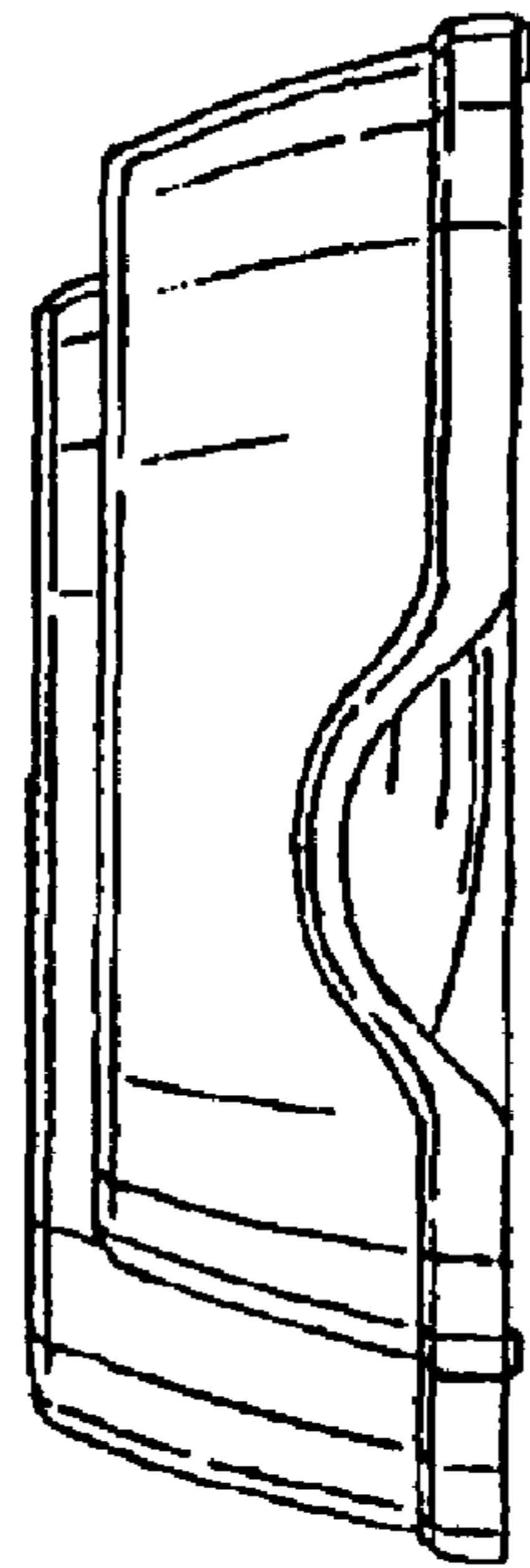

FIG. 13