

US00D504112S

(12) **United States Design Patent**
Suckle et al.

(10) **Patent No.:** **US D504,112 S**
(45) **Date of Patent:** **** Apr. 19, 2005**

(54) **LINE CONDITIONER**

(75) Inventors: **Mitchell Suckle**, Long Beach, CA
(US); **Ernesto Quinteros**, Los Angeles,
CA (US); **David Goetz**, Los Angeles,
CA (US)

(73) Assignee: **Belkin Corporation**, Compton, CA
(US)

(**) Term: **14 Years**

(21) Appl. No.: **29/196,964**

(22) Filed: **Jan. 7, 2004**

(51) **LOC (7) Cl.** **13-02**

(52) **U.S. Cl.** **D13/110**

(58) **Field of Search** D13/101, 110,
D13/112, 118, 162, 164, 184, 199; 307/72,
85-87, 150-151; 361/643, 728

(56) **References Cited**

U.S. PATENT DOCUMENTS

D356,297 S	*	3/1995	Carl et al.	D13/160
D366,248 S	*	1/1996	Owens	D13/184
5,589,718 A	*	12/1996	Lee	307/72
5,649,839 A	*	7/1997	Yu	439/650
D392,615 S	*	3/1998	Basile	D13/123
D405,092 S	*	2/1999	Ohshima et al.	D14/239

D451,883 S	*	12/2001	Reynolds	D13/110
D452,475 S	*	12/2001	Reynolds	D13/110
D458,218 S	*	6/2002	Reynolds	D13/110
D462,658 S	*	9/2002	Reynolds	D13/110
D464,617 S	*	10/2002	Reynolds	D13/110

* cited by examiner

Primary Examiner—Stella Reid

Assistant Examiner—Daniel Bui

(74) *Attorney, Agent, or Firm*—Bryan Cave LLP

(57) **CLAIM**

We claim the ornamental design for an line conditioner, as shown and described.

DESCRIPTION

FIG. 1 is a top plan view of a line conditioner, showing my new design;

FIG. 2 is a bottom plan view thereof;

FIG. 3 is a front elevational view thereof;

FIG. 4 is a rear elevational view thereof;

FIG. 5 is a right side elevational view thereof, the left side elevational view being a mirror image of the right side elevational view; and,

FIG. 6 is a front, right, top isometric view thereof.

The broken line showing of the environment is for illustrative purposes only and forms no part of the claimed design.

1 Claim, 2 Drawing Sheets

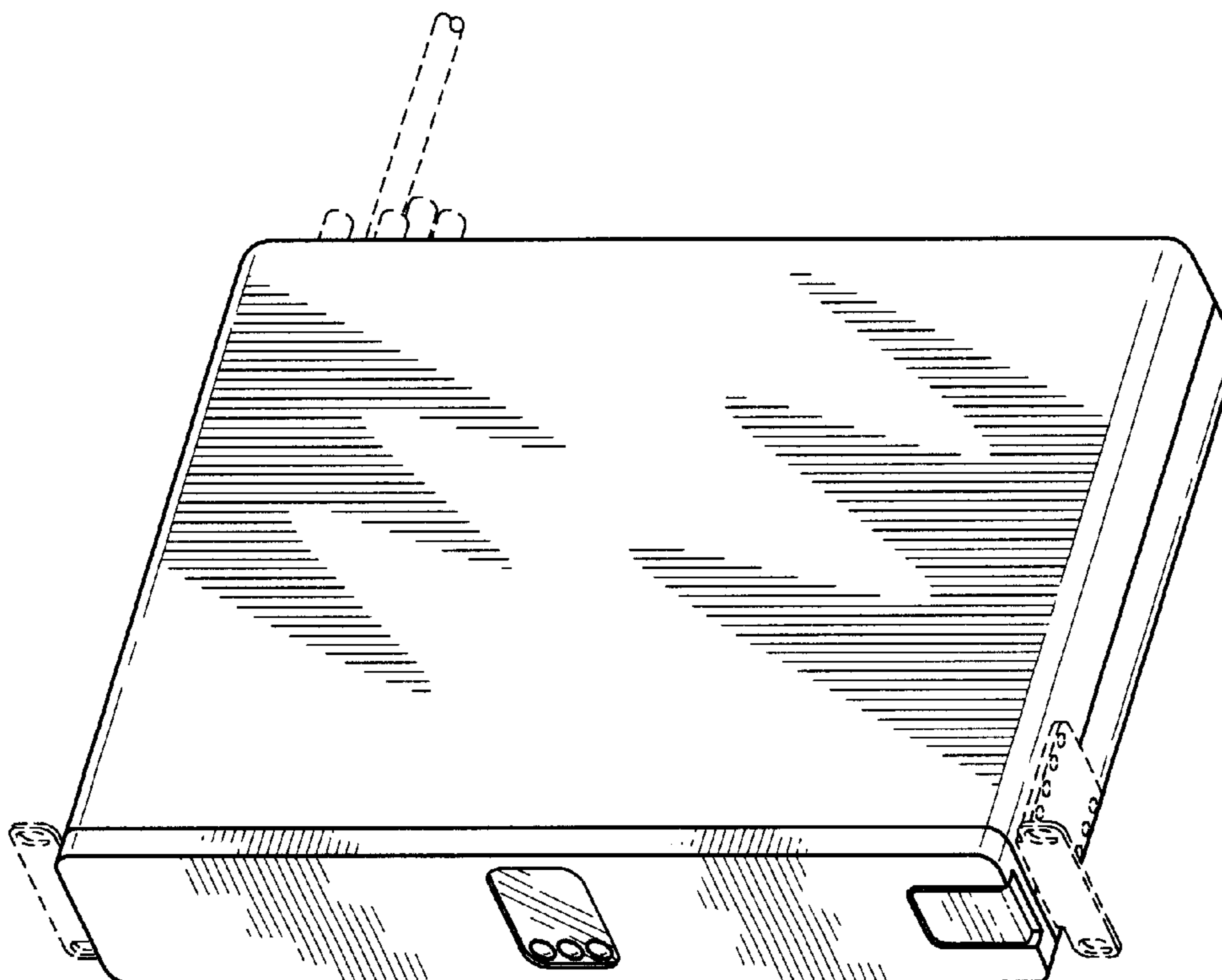

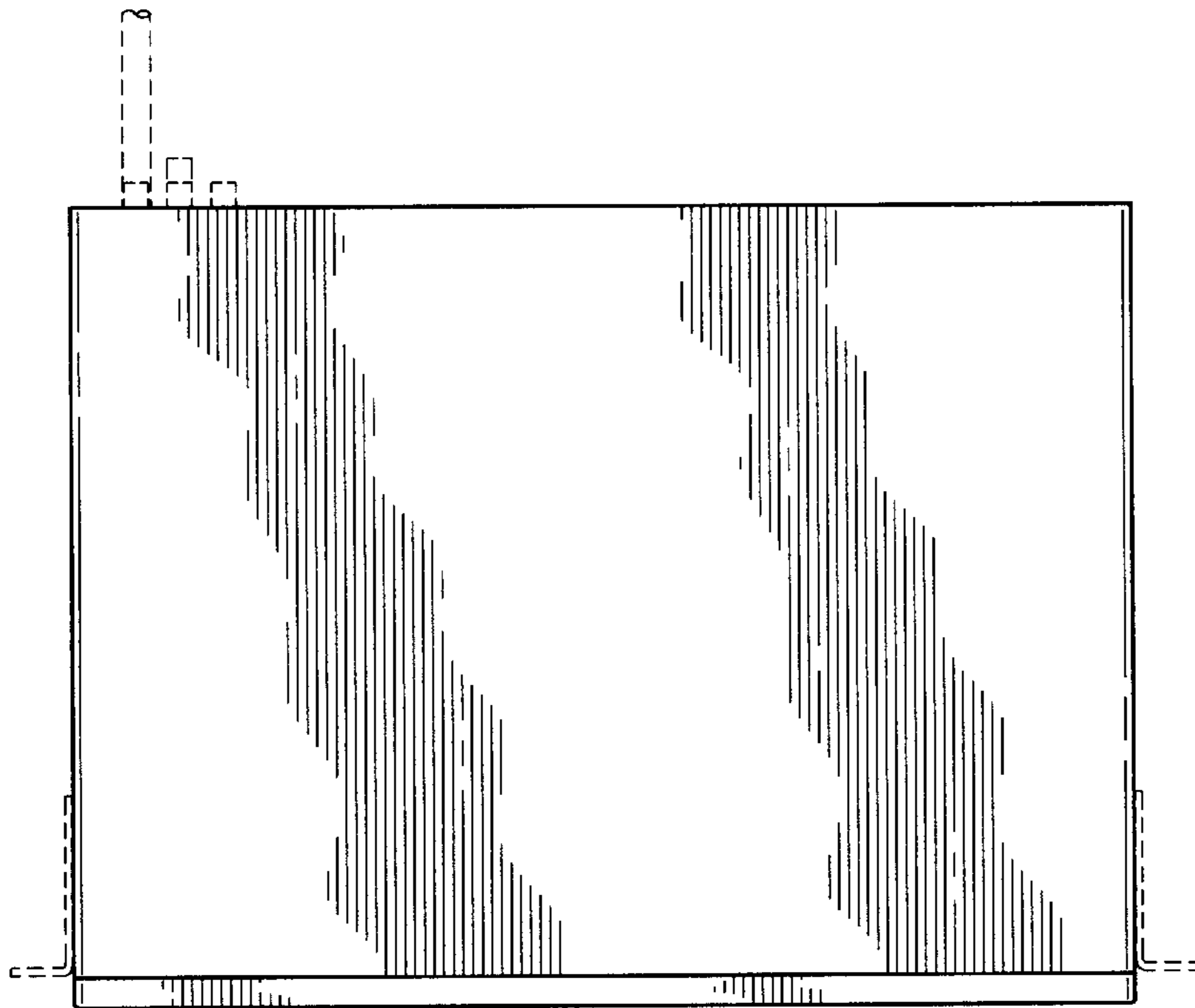

FIG. 1

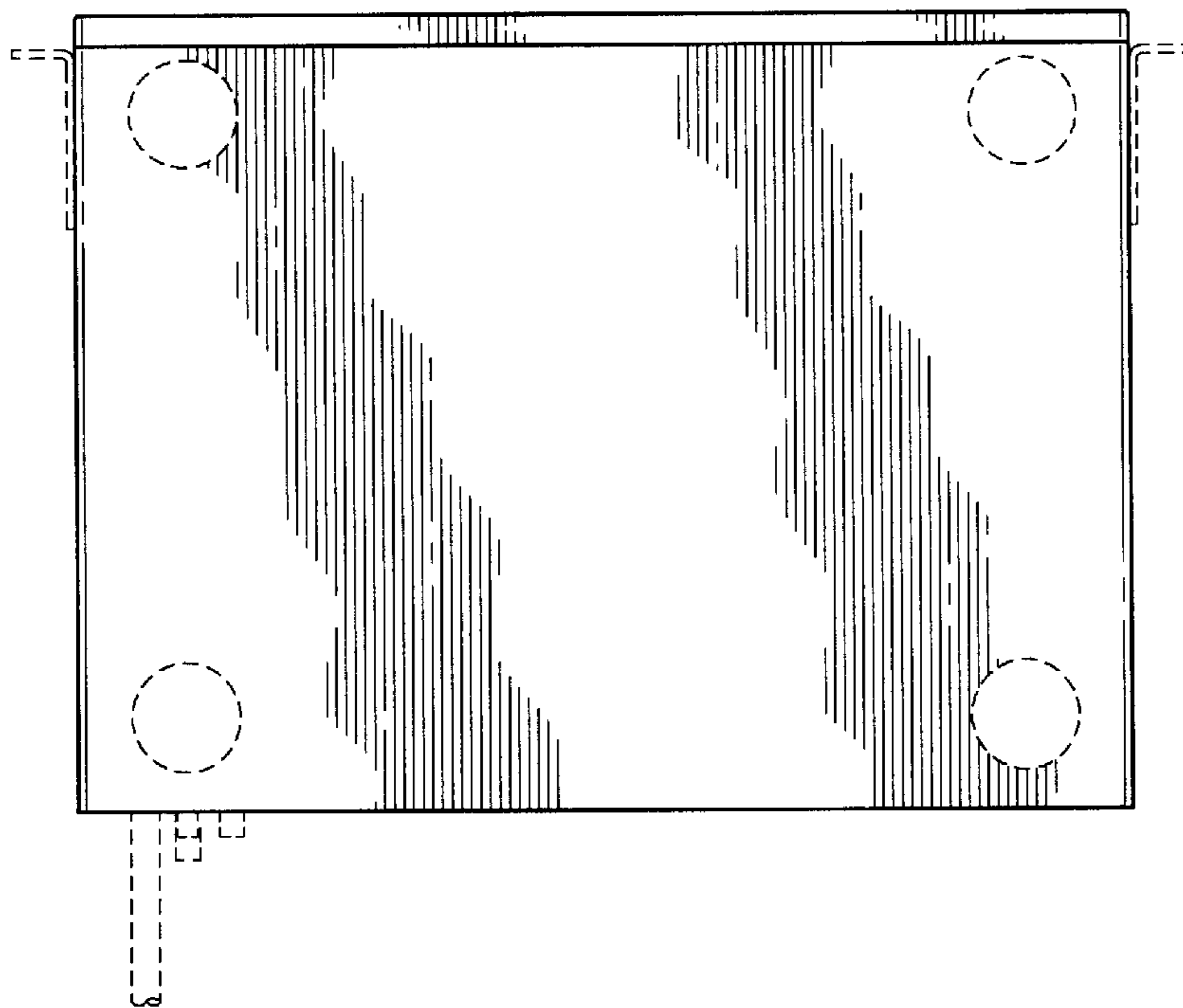

FIG. 2

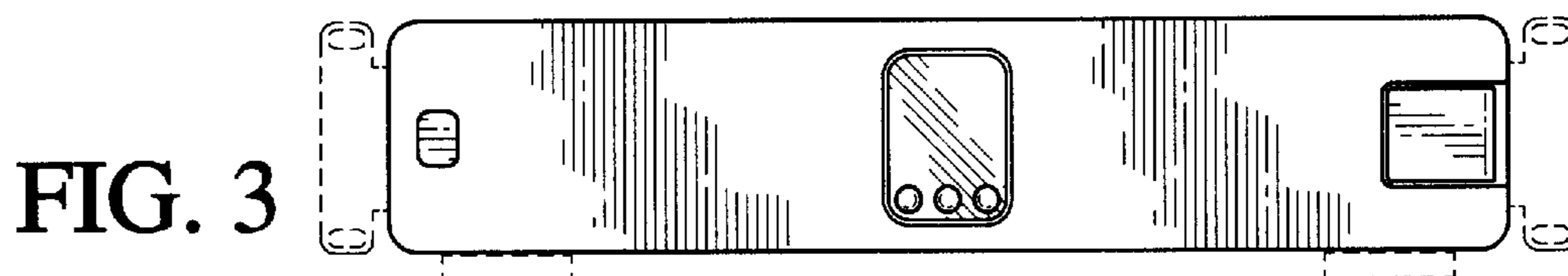

FIG. 3

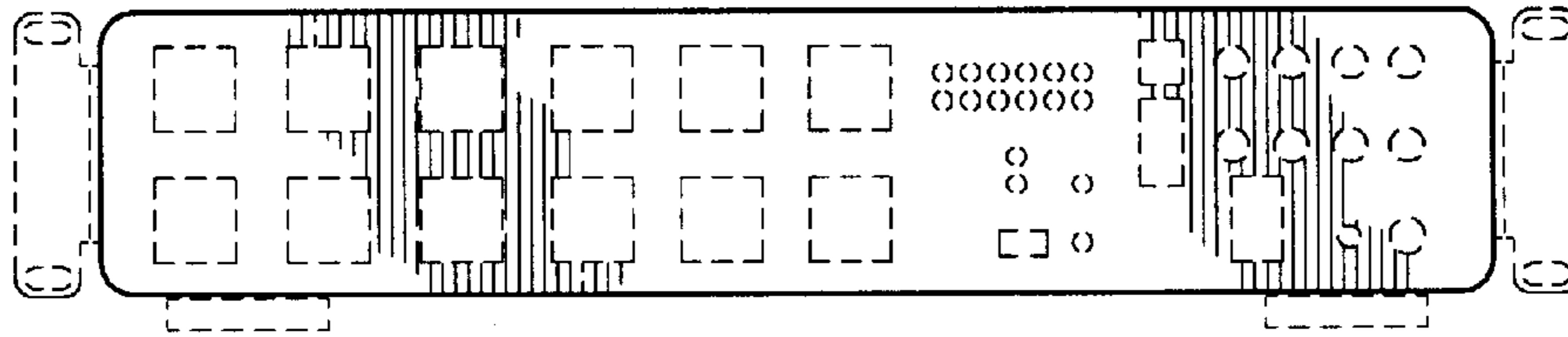

FIG. 4

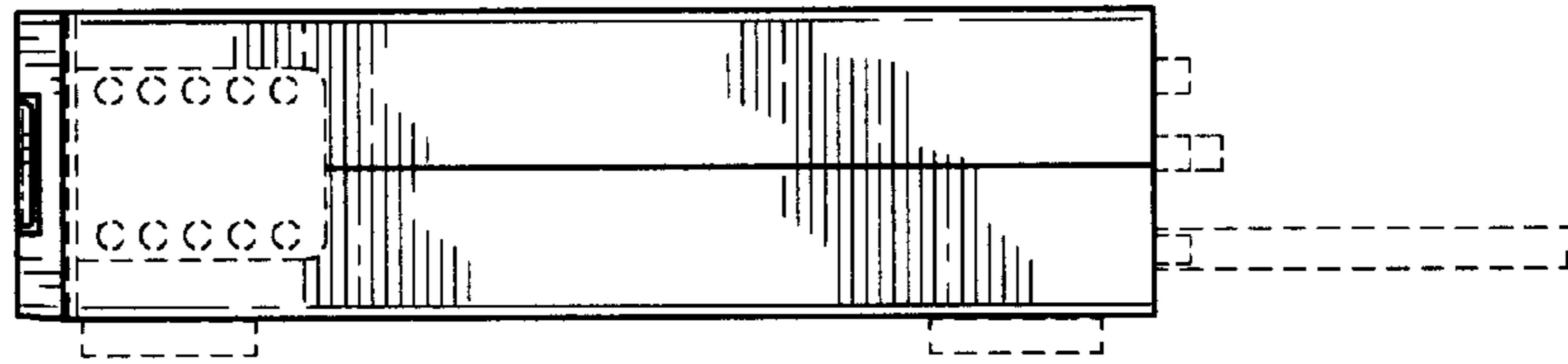

FIG. 5

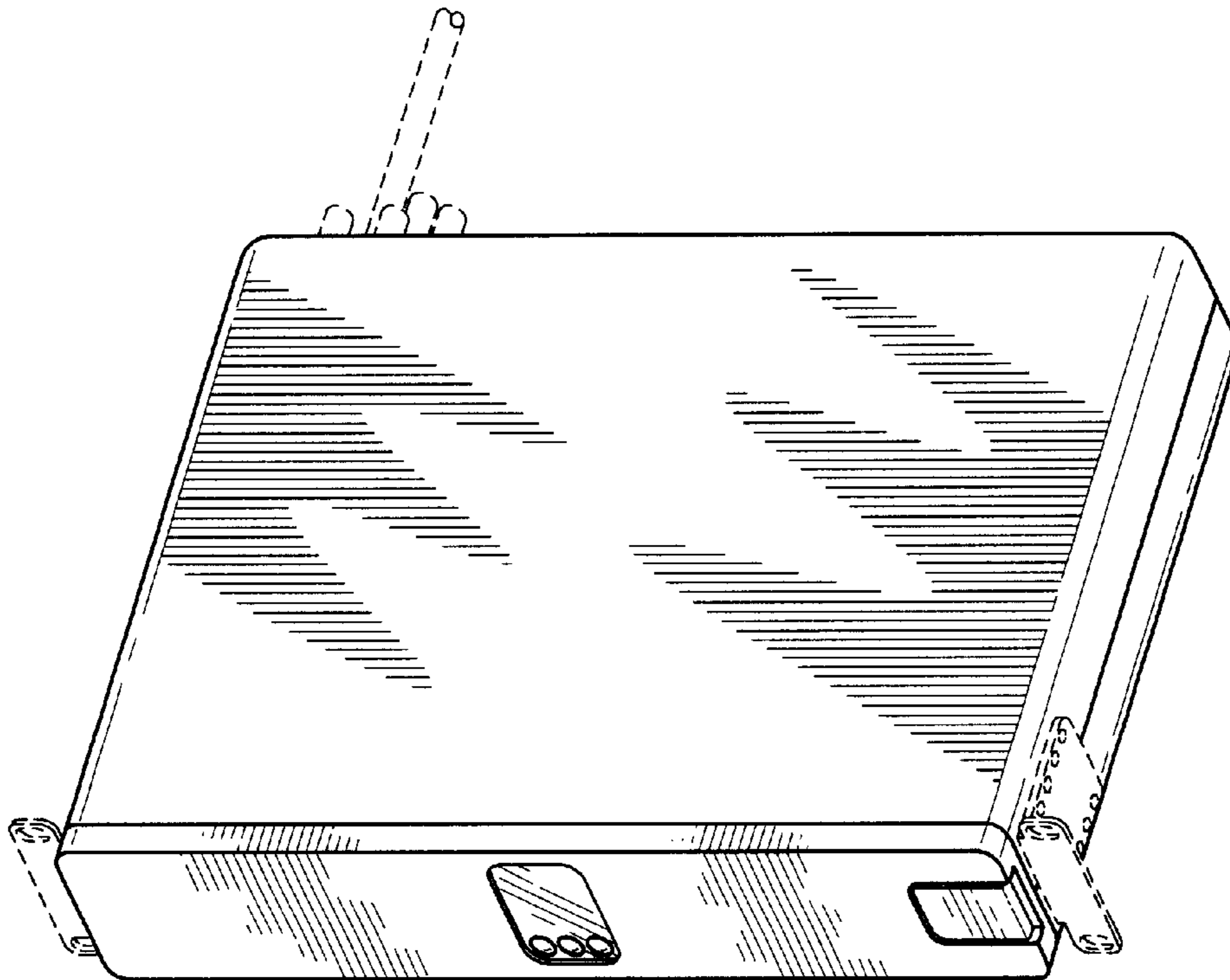

FIG. 6