



US00D504053S

(12) **United States Design Patent**  
**Bertulis**

(10) **Patent No.:** **US D504,053 S**

(45) **Date of Patent:** **\*\* Apr. 19, 2005**

(54) **CONTAINER WITH INNER AND OUTER LID**

(75) Inventor: **Eugenia M. Bertulis**, Seattle, WA (US)

(73) Assignee: **Progressive International Corp.**, Kent, WA (US)

(\*\*) Term: **14 Years**

(21) Appl. No.: **29/180,846**

(22) Filed: **Apr. 30, 2003**

(51) **LOC (7) Cl.** ..... **07-07**

(52) **U.S. Cl.** ..... **D7/629**

(58) **Field of Search** ..... D7/391-392.1,  
D7/601, 602, 629, 538-549; D9/414, 424-429;  
206/508, 509, 4.21, 776; 229/4.5, 5.5, 406,  
407, 103.11, 938; 220/574-574.2, 675,  
669-676, 780-799

(56) **References Cited**

**U.S. PATENT DOCUMENTS**

- 3,915,532 A \* 10/1975 Ashton ..... 220/574.2
- D332,897 S \* 2/1993 Bucher et al. .... D7/629
- D415,420 S \* 10/1999 Chen ..... D9/428
- D445,687 S \* 7/2001 Gilbertson ..... D9/454

\* cited by examiner

*Primary Examiner*—Terry A. Wallace

(74) *Attorney, Agent, or Firm*—Black Lowe and Graham

(57) **CLAIM**

I claim the ornamental design for the container with inner and outer lid, as shown and described.

**DESCRIPTION**

FIG. 1 is a perspective view of a container with inner and out lid showing my new design;

FIG. 2 is a left side view thereof, the right side view being a mirror image;

FIG. 3 is a front view thereof;

FIG. 4 is a rear view thereof;

FIG. 5 is a top plan view thereof;

FIG. 6 is a bottom plan view thereof;

FIG. 7 is a perspective view thereof with the out lid removed;

FIG. 8 is a left side view of FIG. 7;

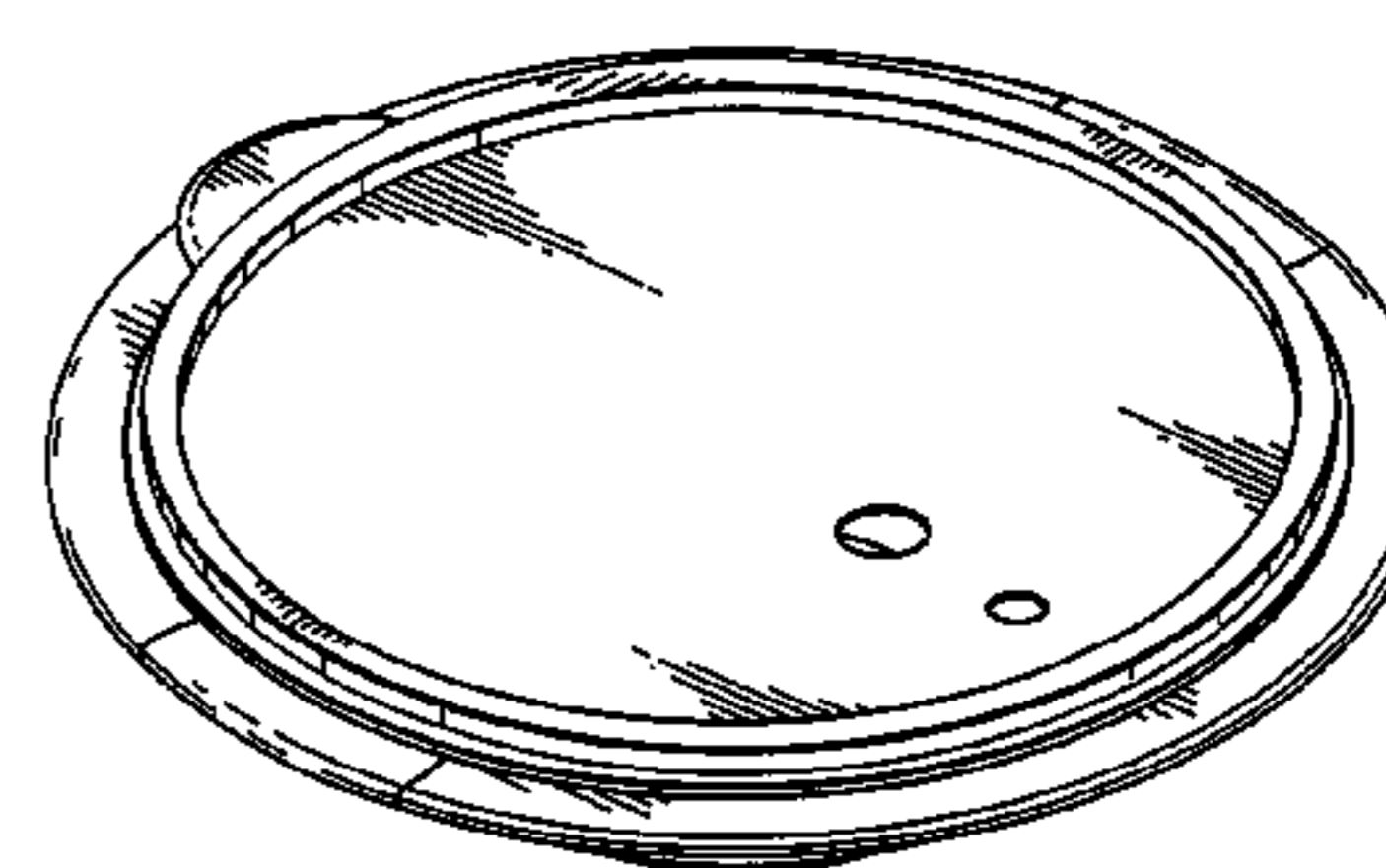
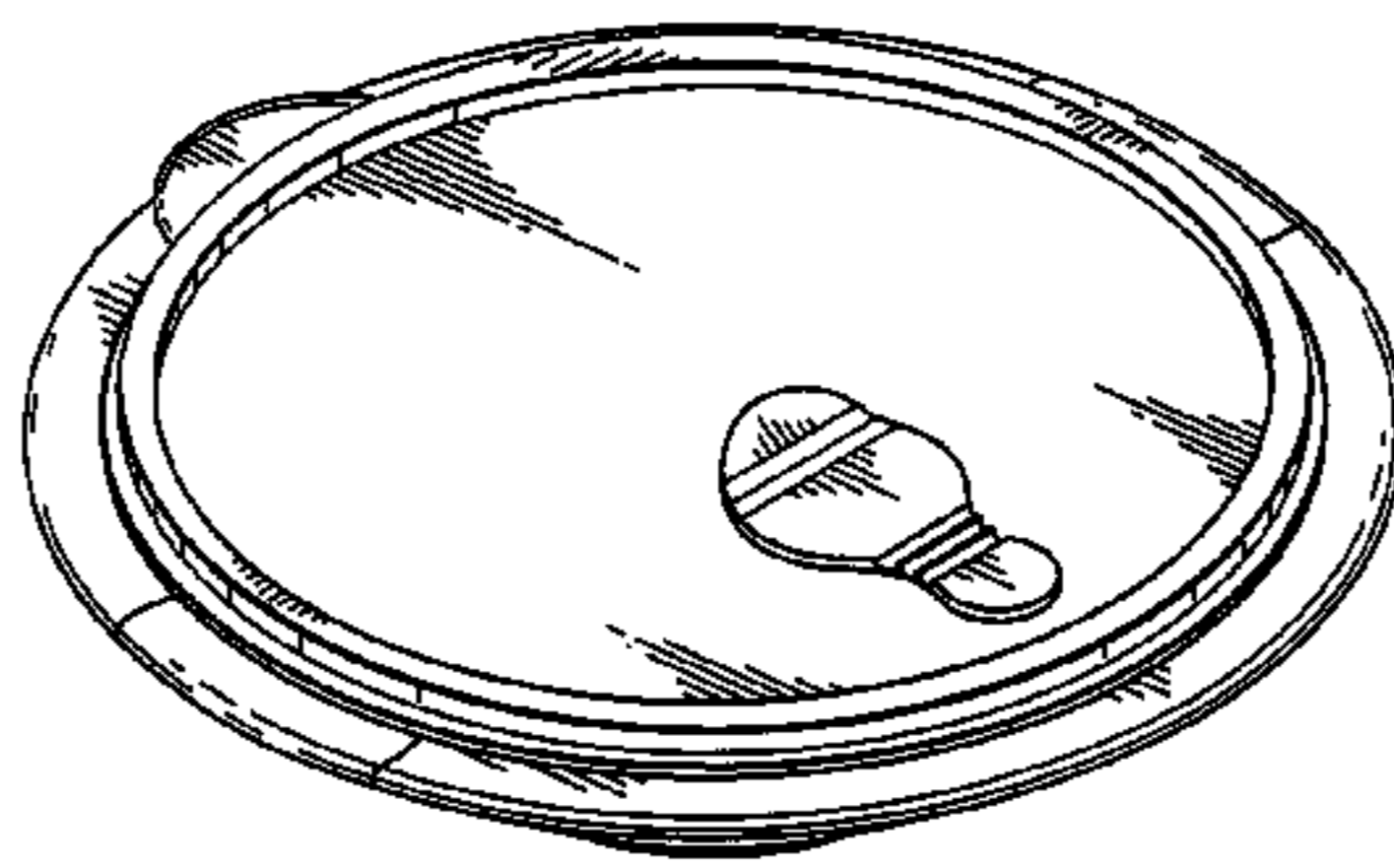
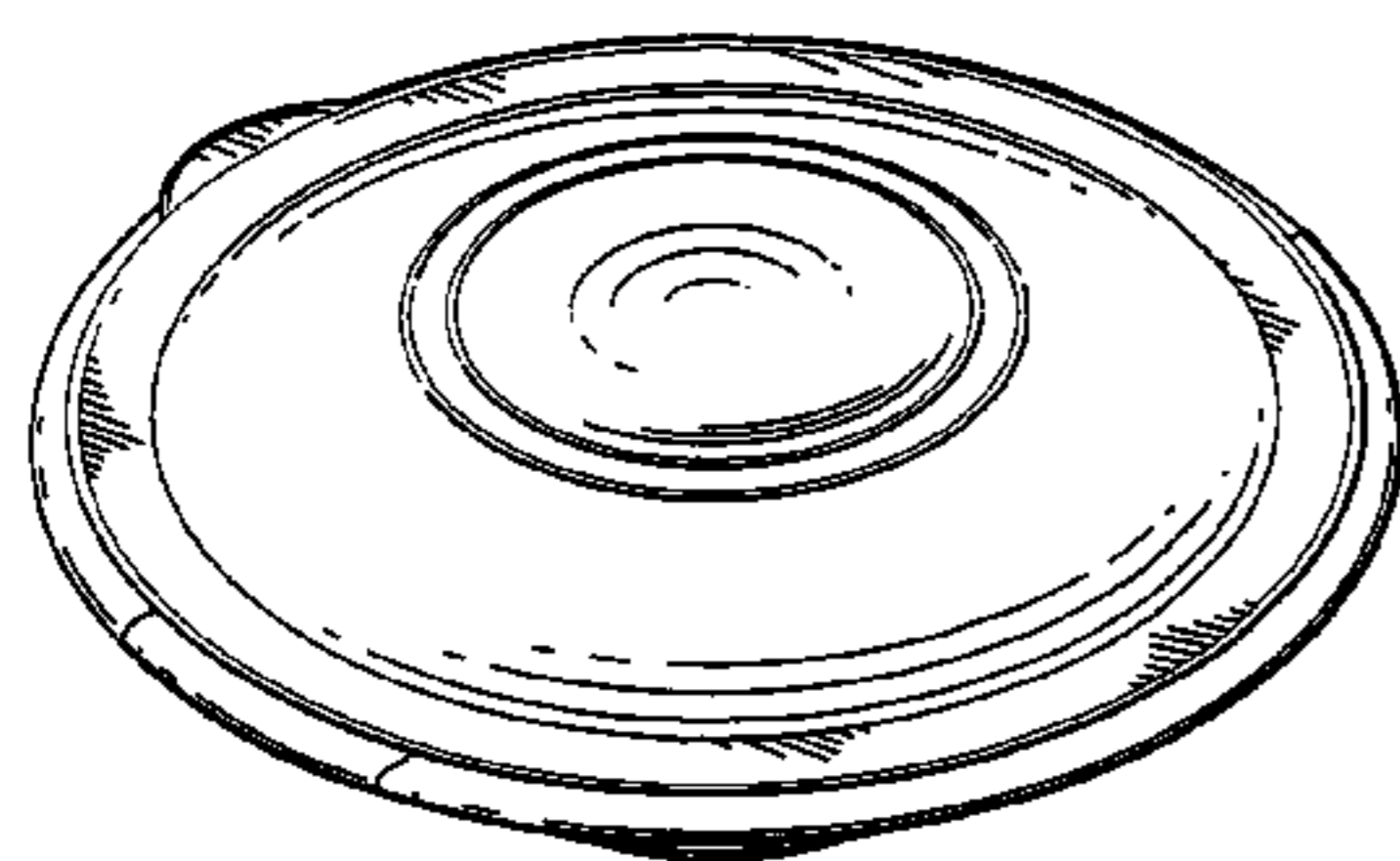
FIG. 9 is a front view of FIG. 7;

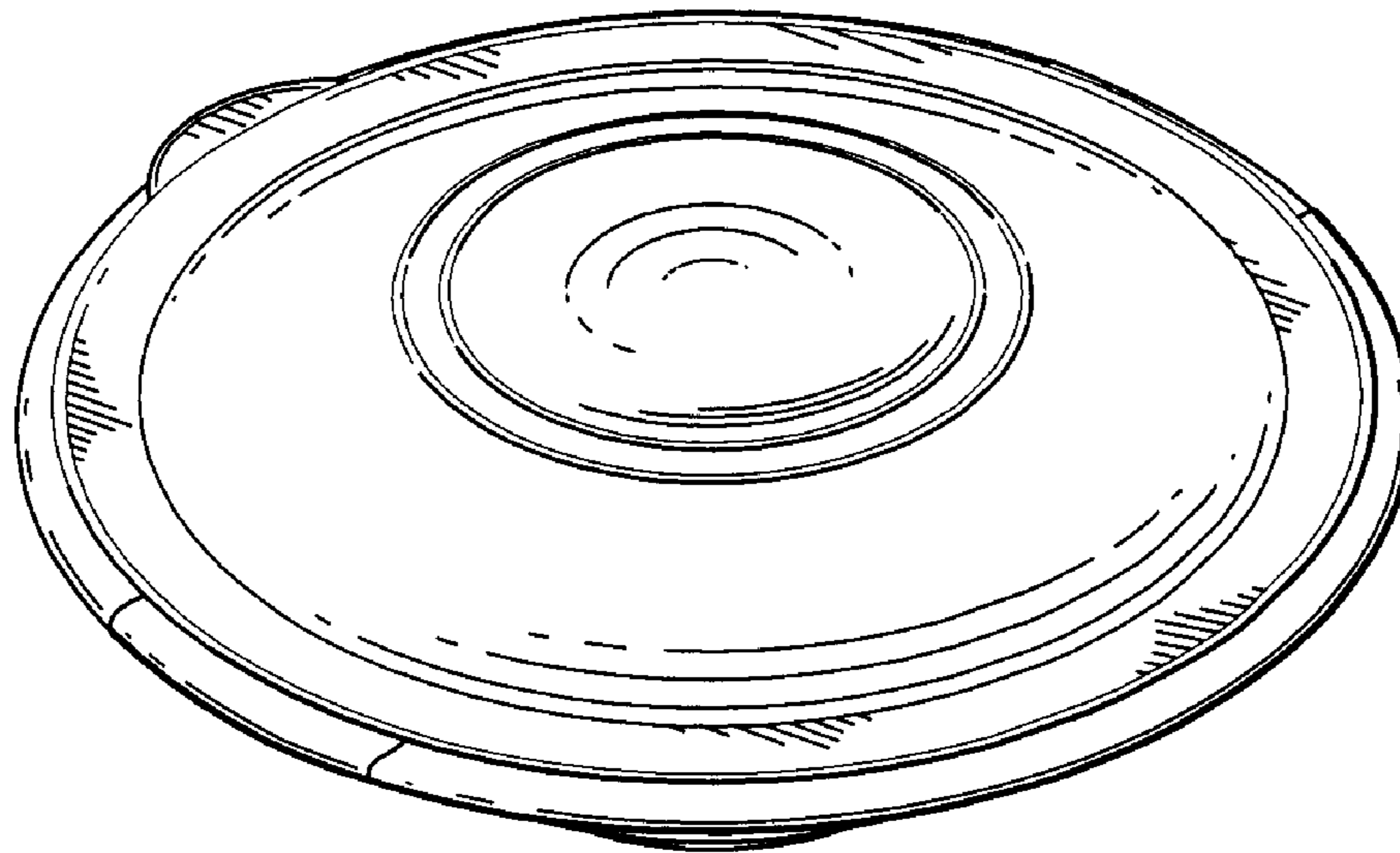
FIG. 10 is a rear view of FIG. 7;

FIG. 11 is a top plan view of FIG. 7; and,

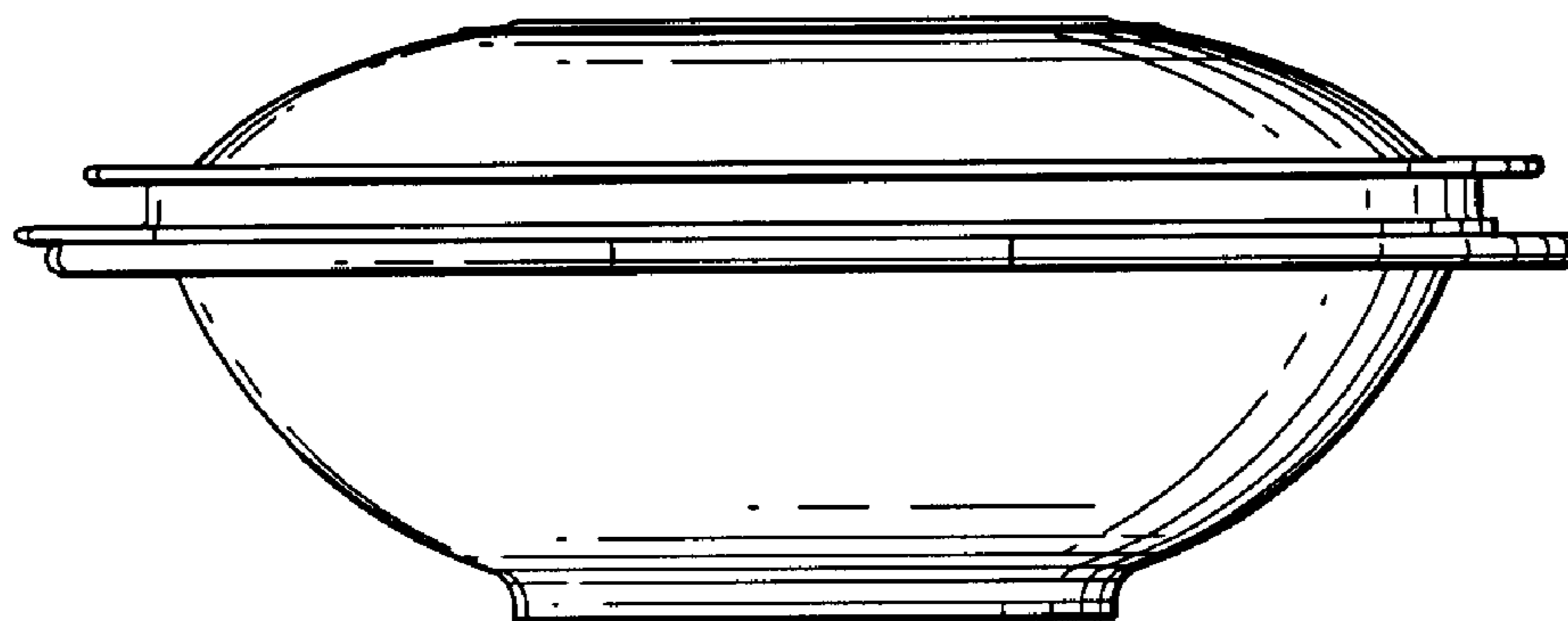
FIG. 12 is a perspective view of FIG. 7 with the vent cover removed.

**1 Claim, 6 Drawing Sheets**

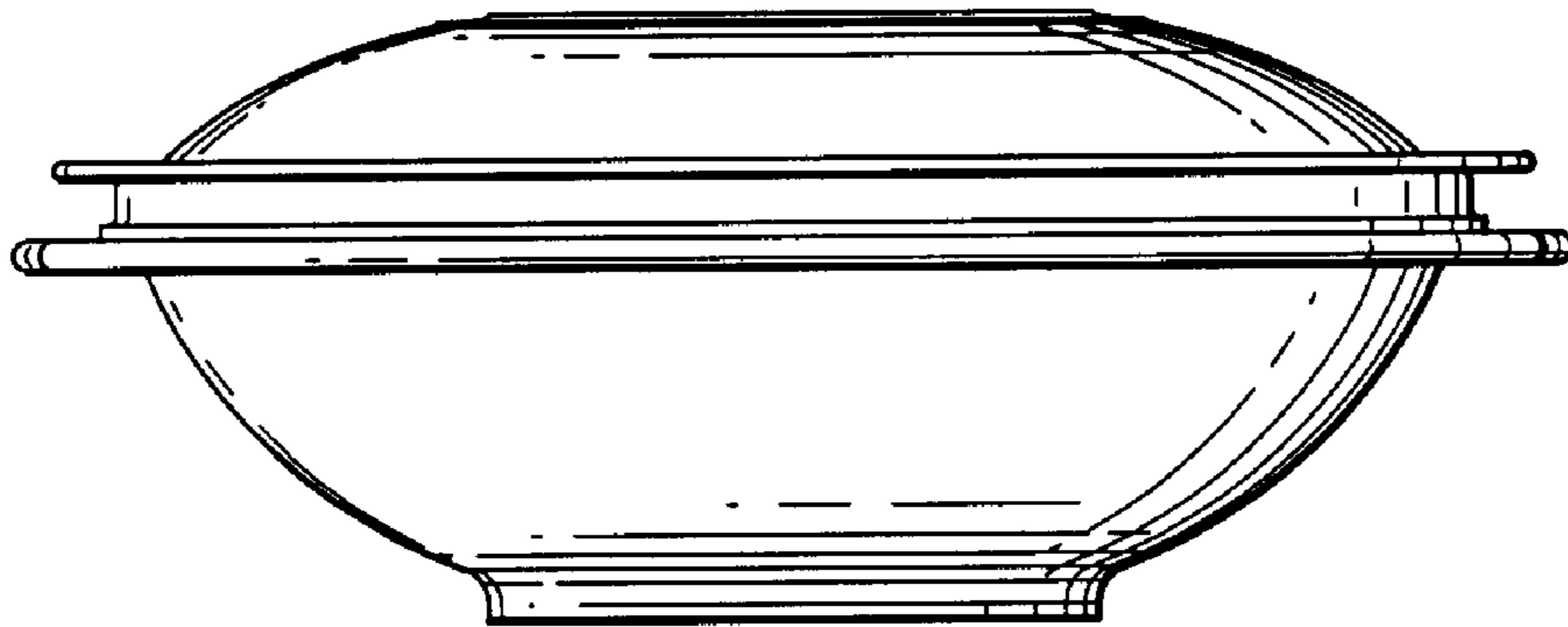




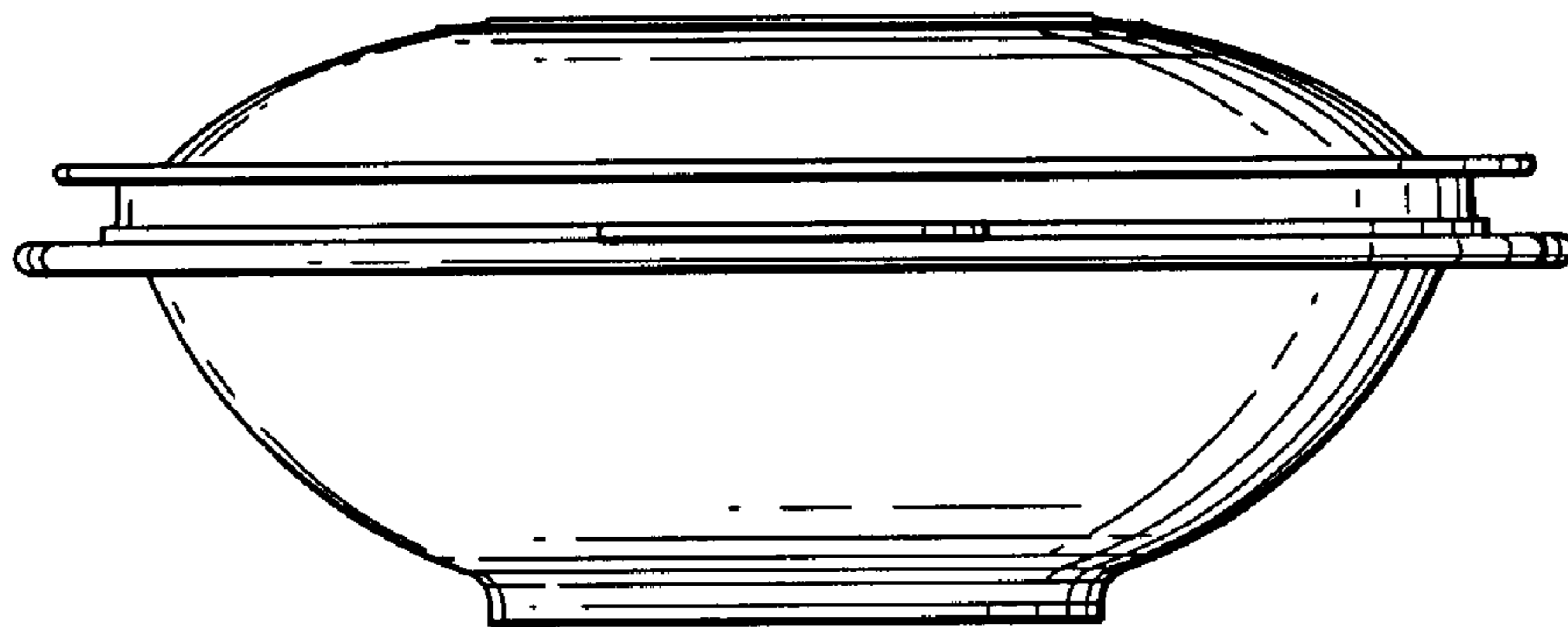
*Fig. 1.*



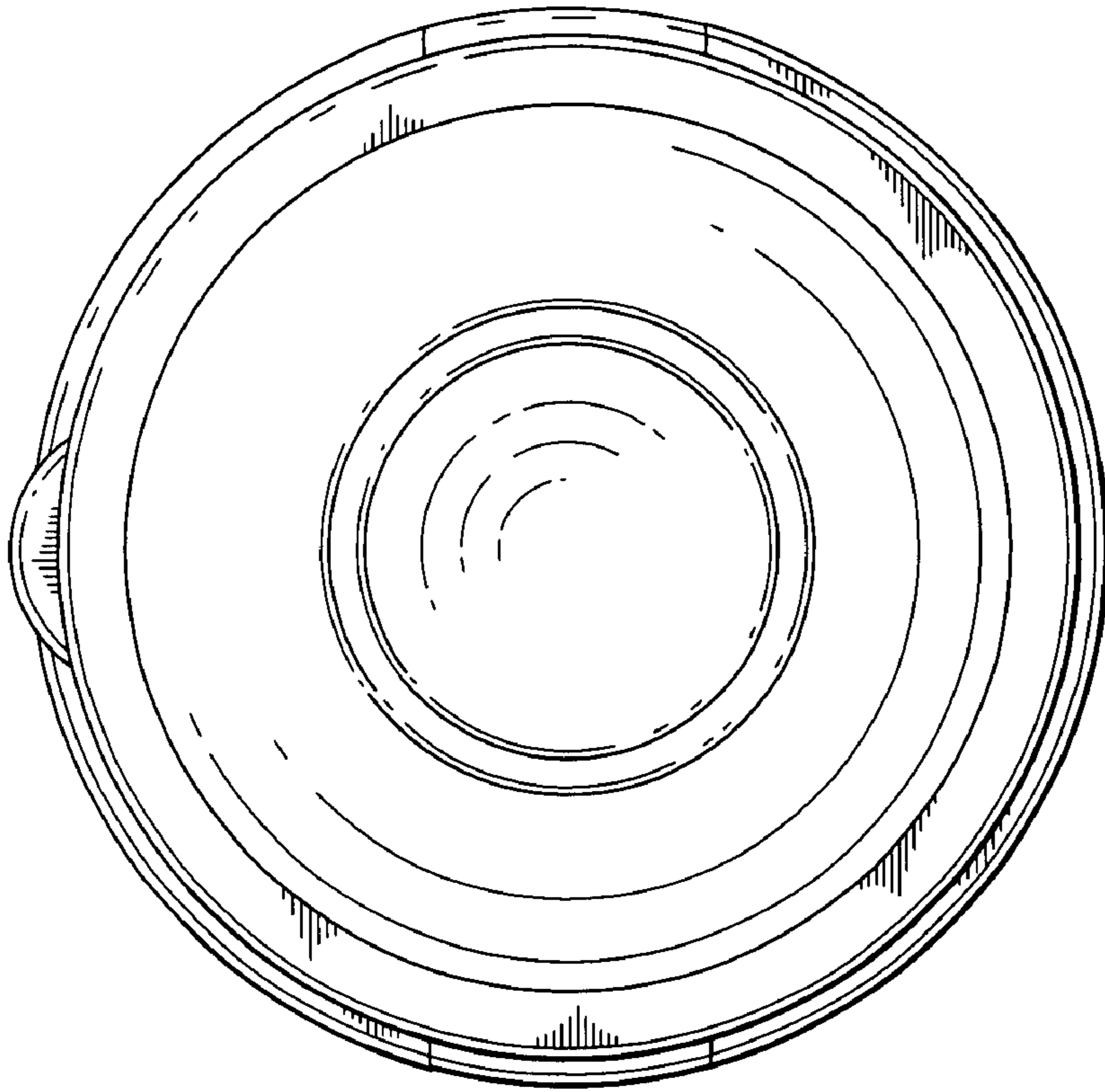
*Fig. 2.*



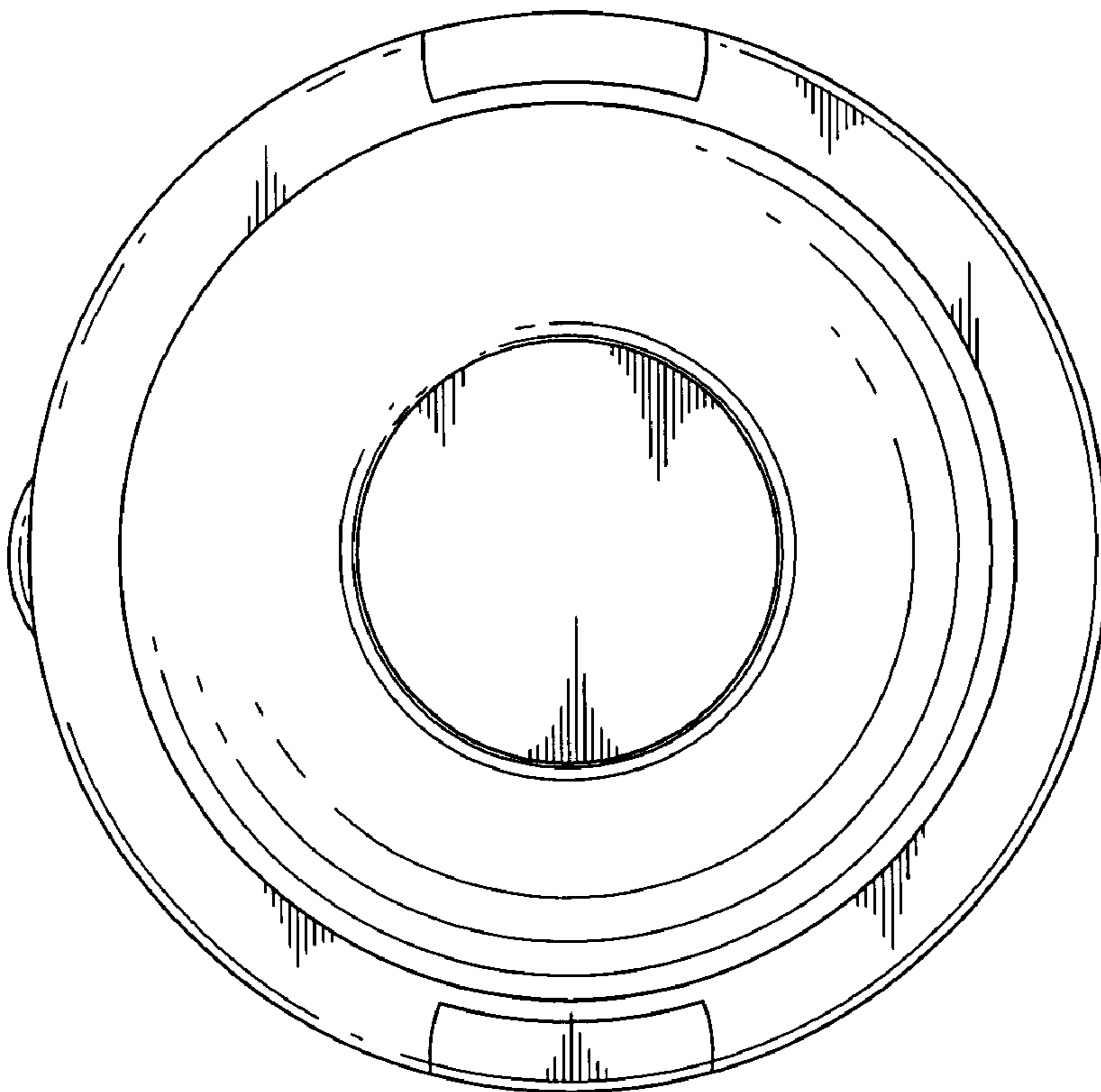
*Fig. 3.*



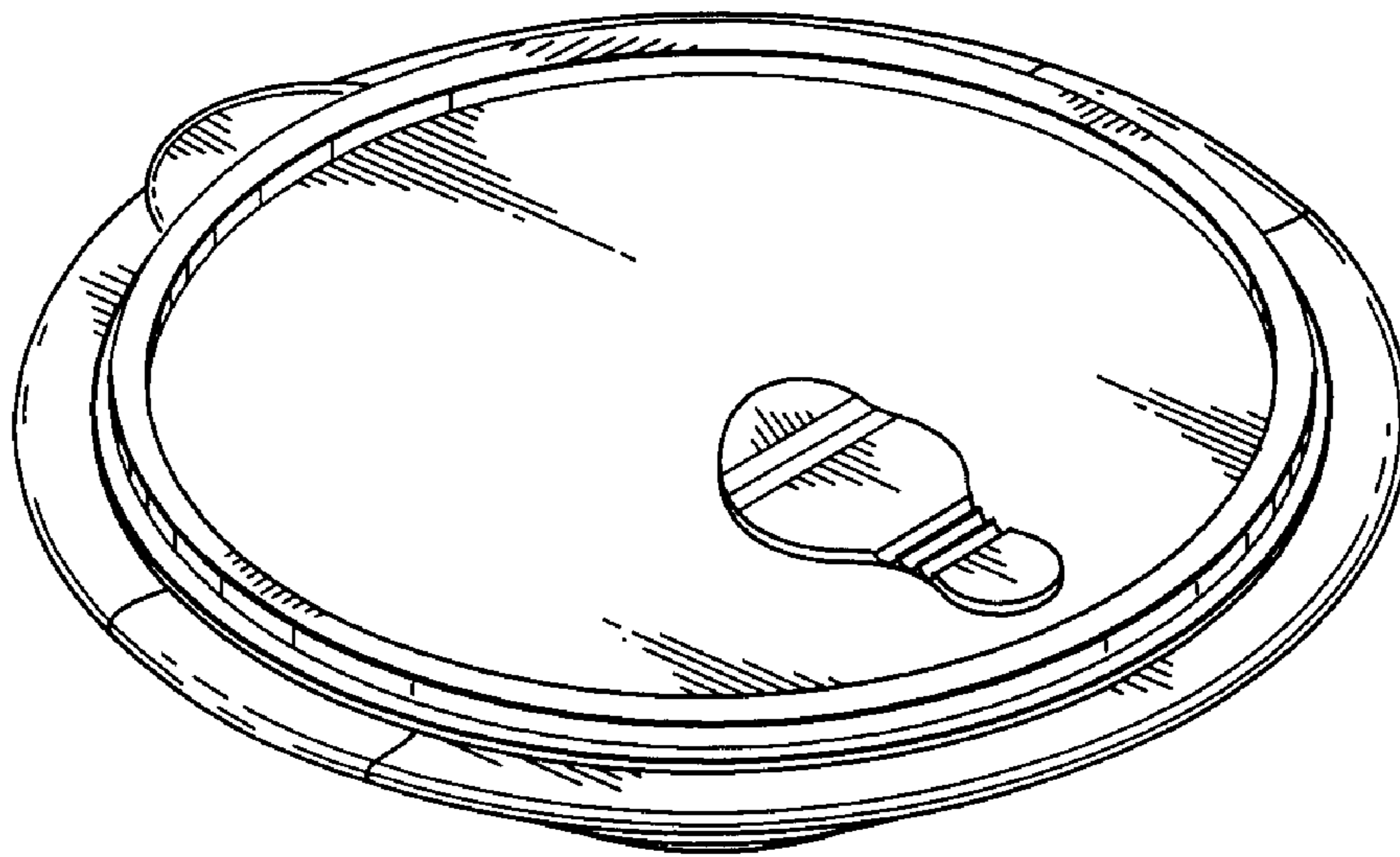
*Fig. 4.*



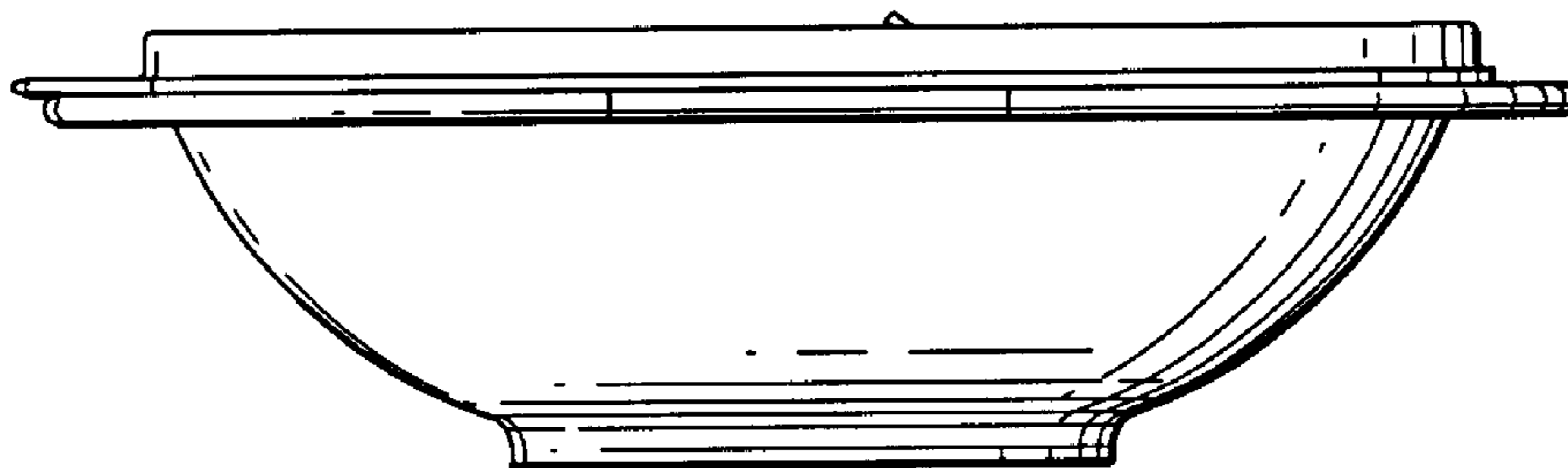
*Fig. 5.*



*Fig. 6.*

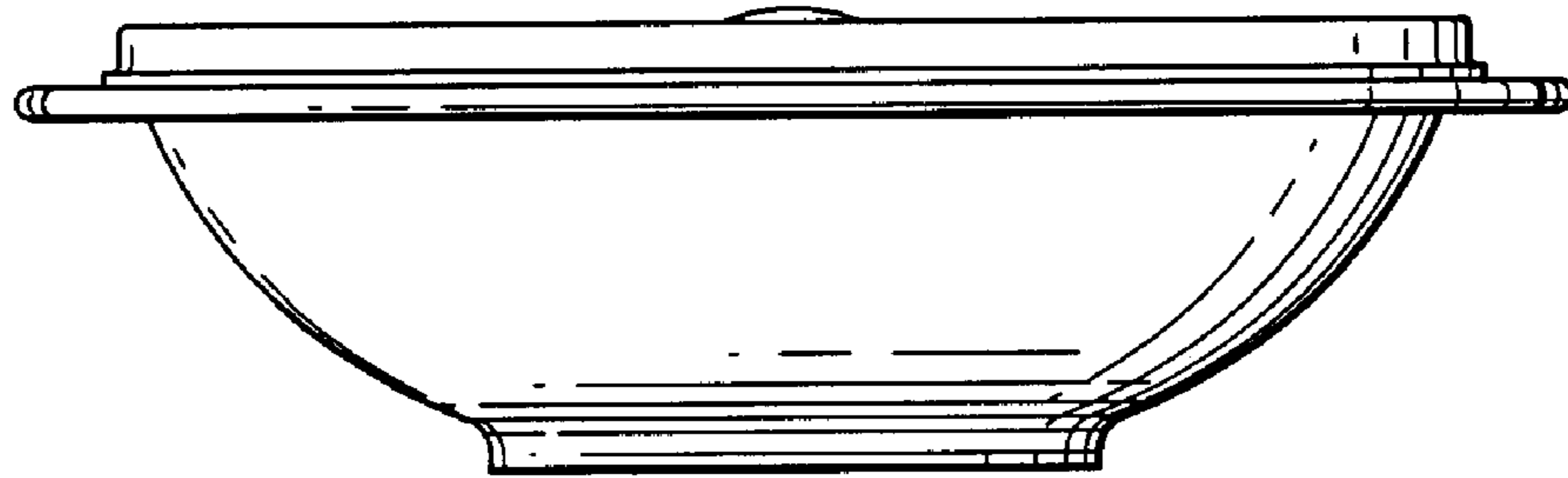


*Fig. 7.*

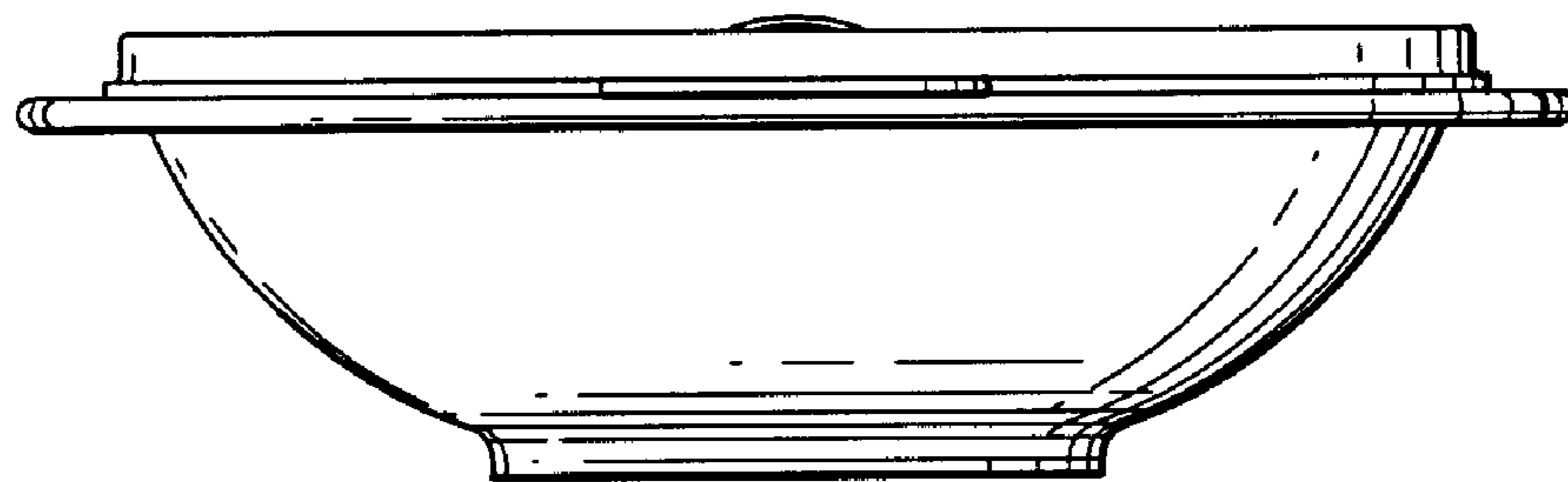


*Fig. 8.*

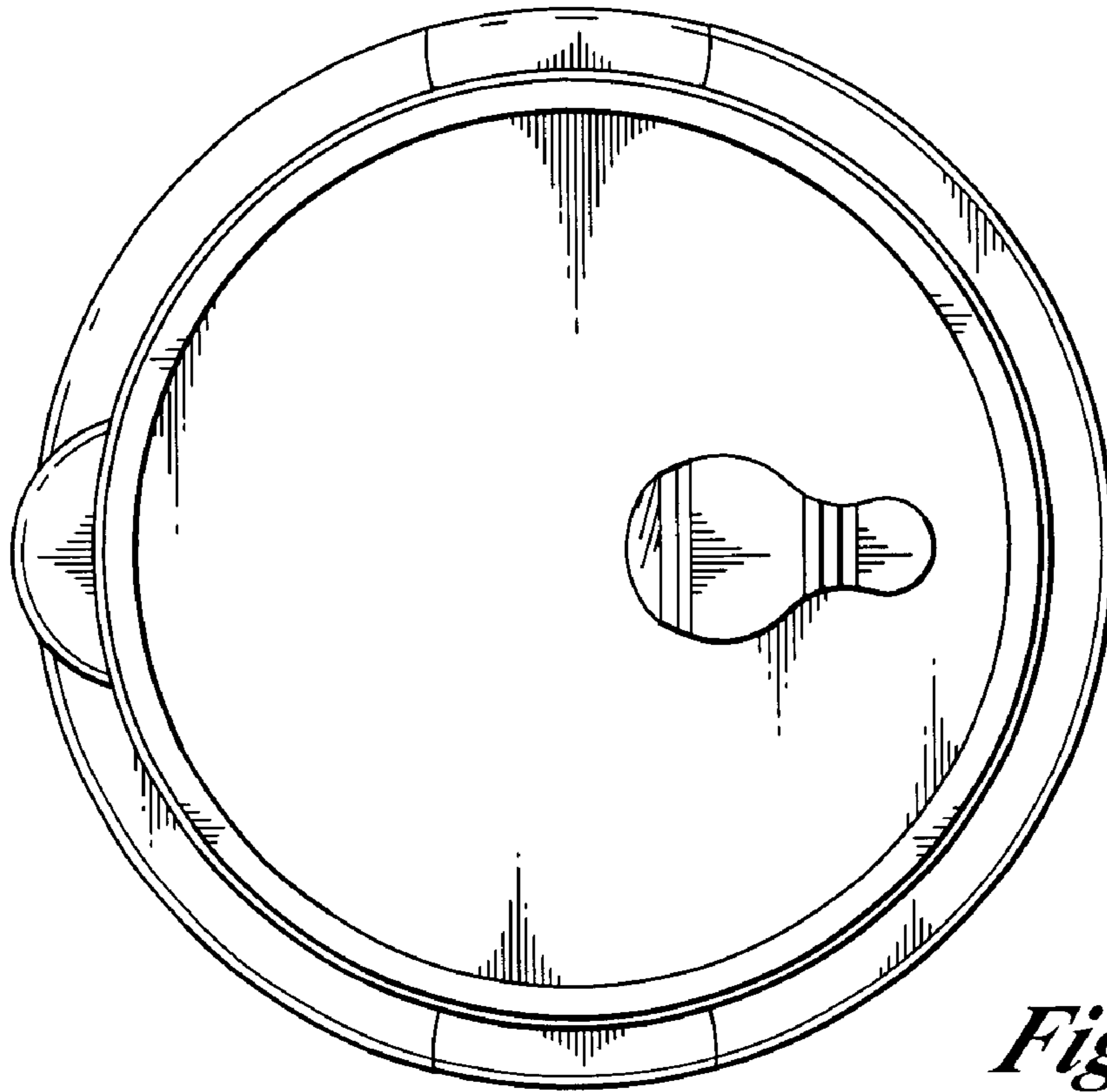




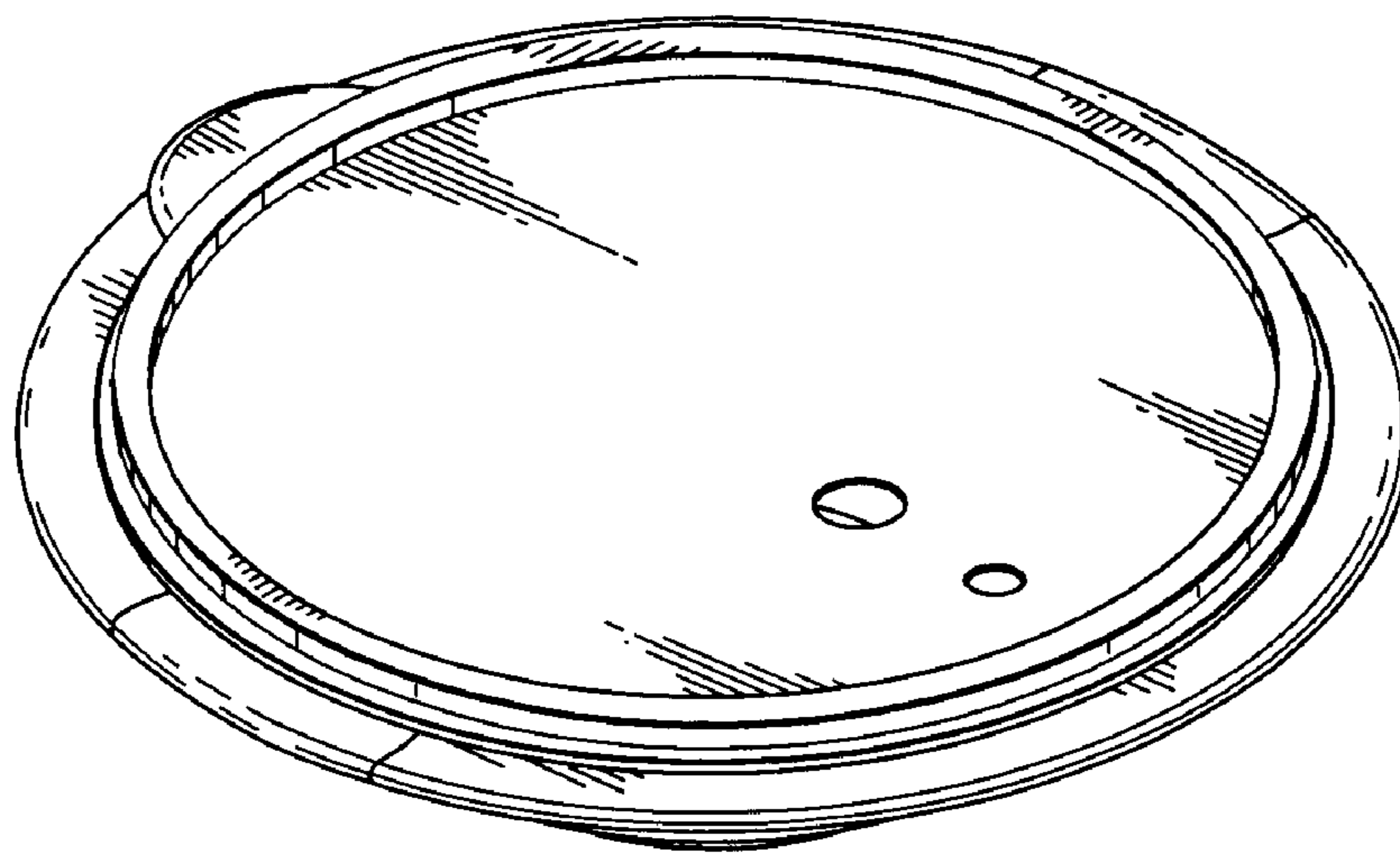
*Fig. 9.*



*Fig. 10.*



*Fig. 11.*



*Fig. 12.*