



US00D504052S

(12) **United States Design Patent**
Wang

(10) **Patent No.:** **US D504,052 S**
(45) **Date of Patent:** **** Apr. 19, 2005**

(54) **FOOD CONTAINER**

D401,141 S * 11/1998 Carroll et al. D9/608

(75) Inventor: **Tzu-Chung Wang**, Chang-Hua (TW)

* cited by examiner

(73) Assignee: **Jojomo Enterprise Co., Ltd.**, Chang Hua (TW)

Primary Examiner—Terry A. Wallace

(**) Term: **14 Years**

(57) **CLAIM**

The ornamental design for food container, as shown and described.

(21) Appl. No.: **29/197,086**

(22) Filed: **Jan. 10, 2004**

DESCRIPTION

(51) **LOC (7) Cl.** **07-01**

FIG. 1 is a perspective view of food container showing my new design;

(52) **U.S. Cl.** **D7/628; D9/608**

FIG. 2 is a front elevational view thereof;

(58) **Field of Search** D7/628, 516, 519;

FIG. 3 is a rear elevational view thereof;

D9/608; 206/457; 215/400

FIG. 4 is a left side elevational view thereof;

FIG. 5 is right side elevational view thereof;

(56) **References Cited**

FIG. 6 is a top view thereof; and,

FIG. 7 is a bottom view thereof.

U.S. PATENT DOCUMENTS

5,386,909 A * 2/1995 Spector 206/457

D358,300 S * 5/1995 Brown et al. D7/516

1 Claim, 7 Drawing Sheets

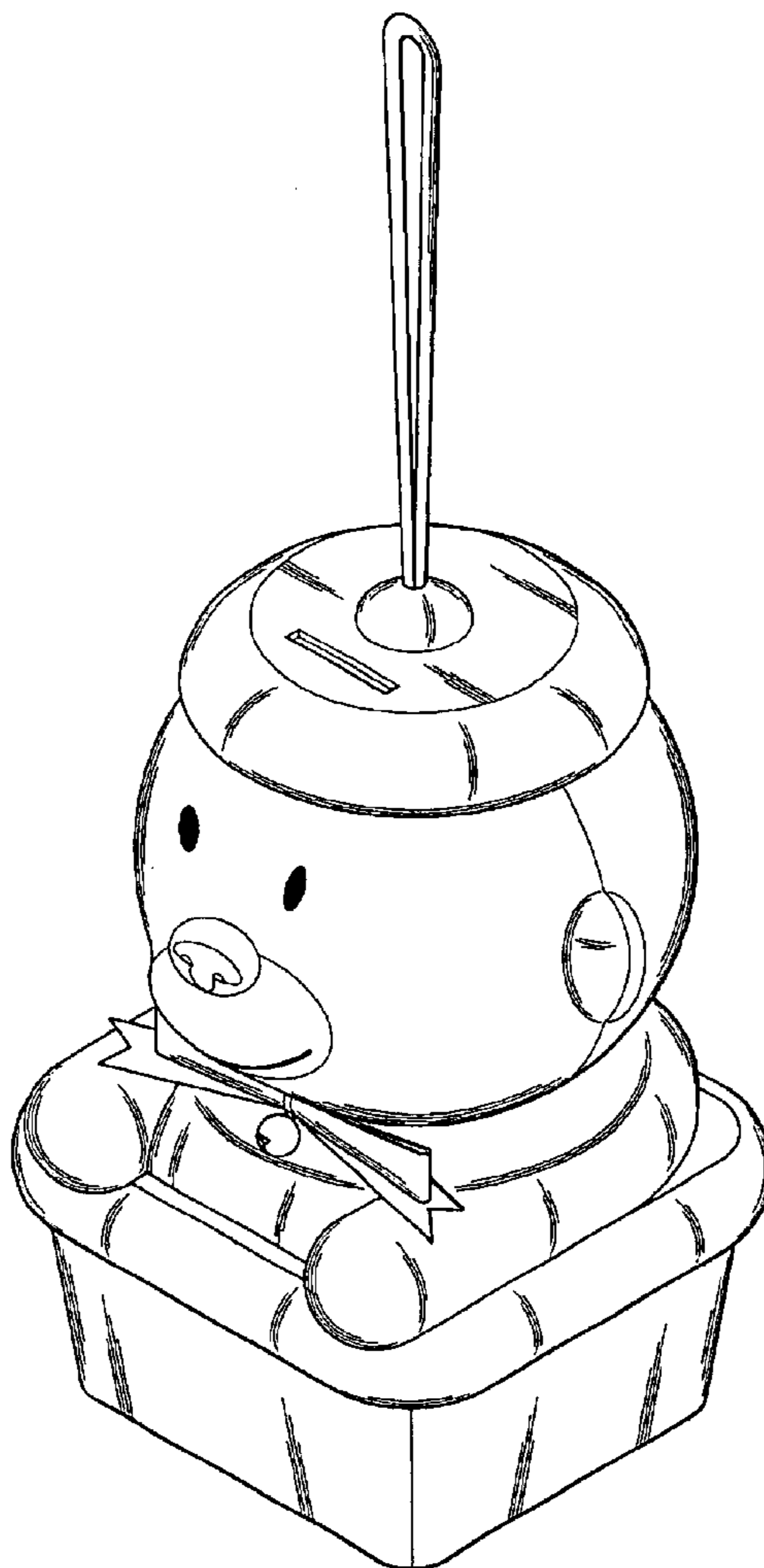

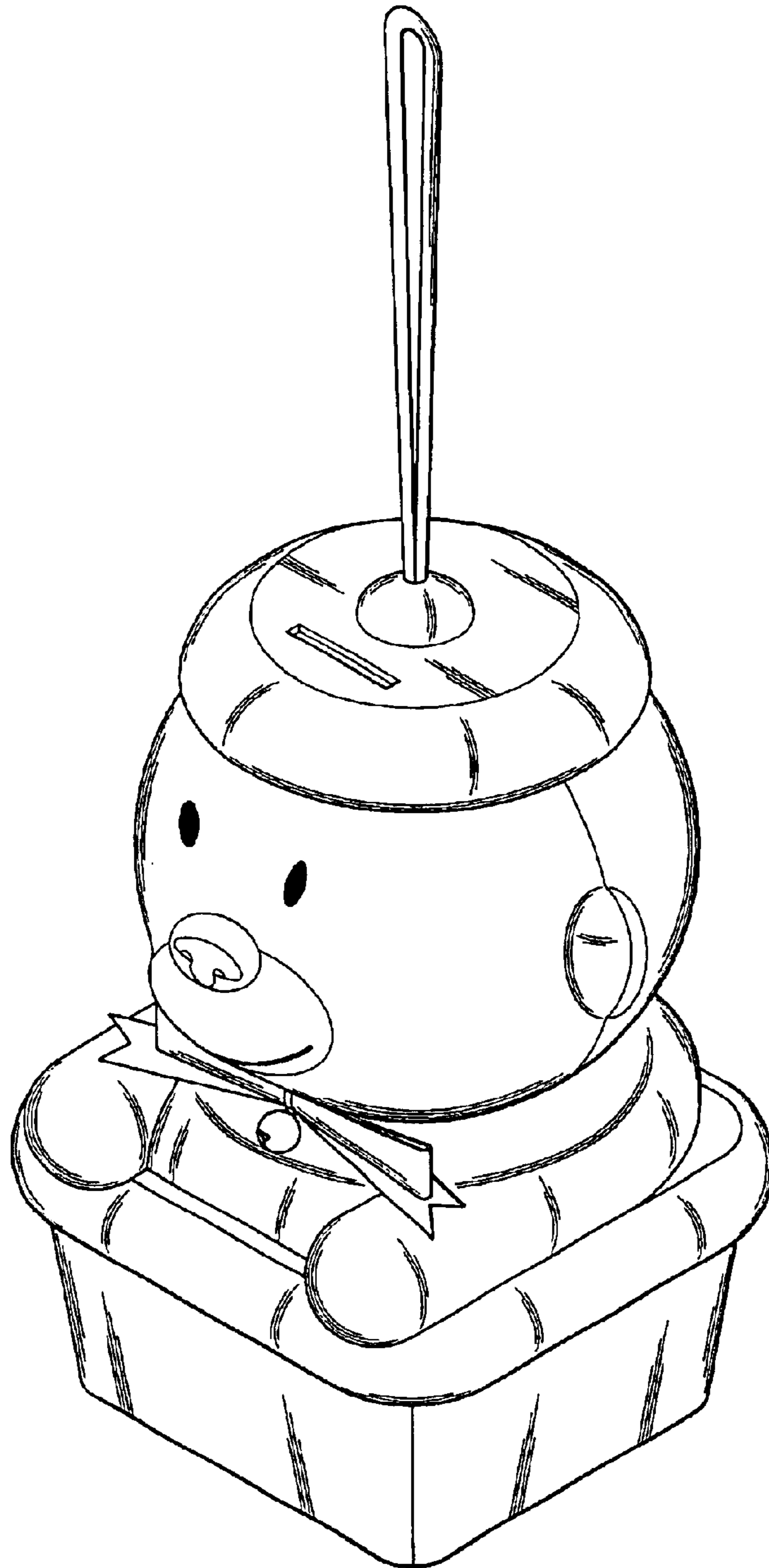

FIG. 1

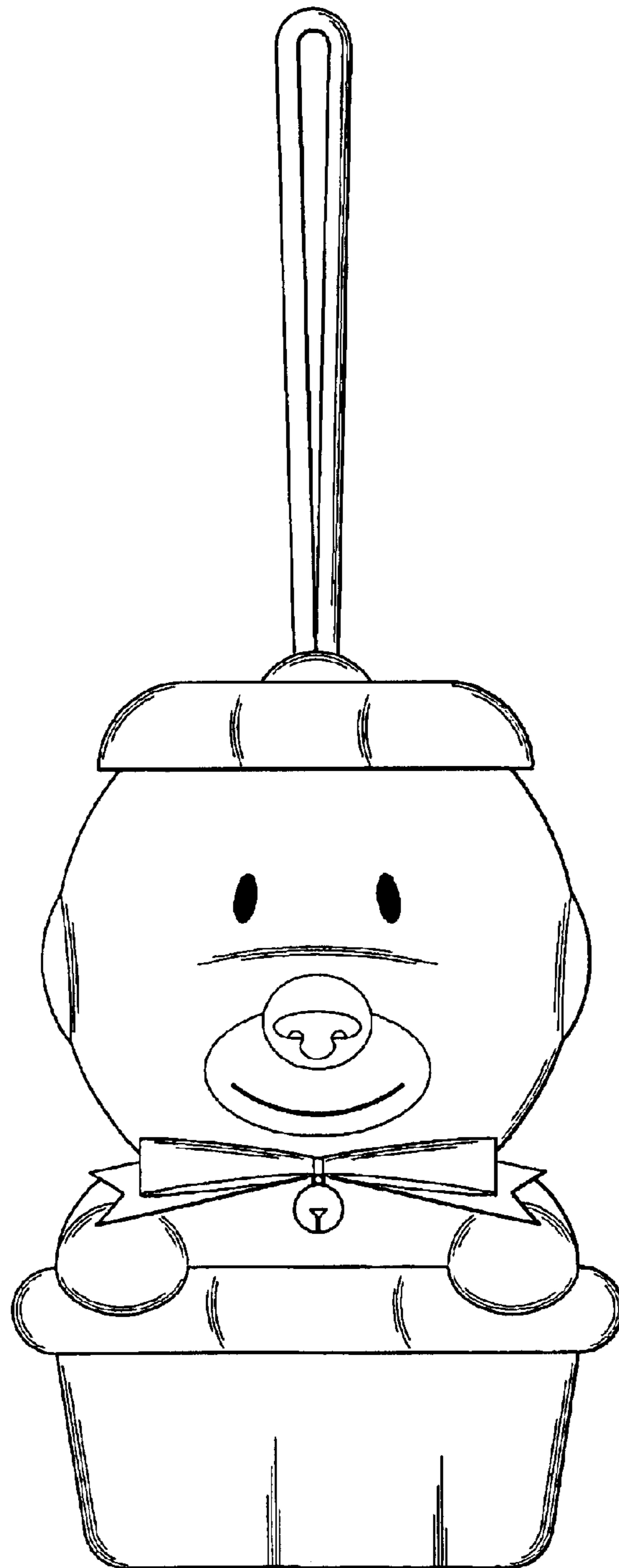

FIG. 2

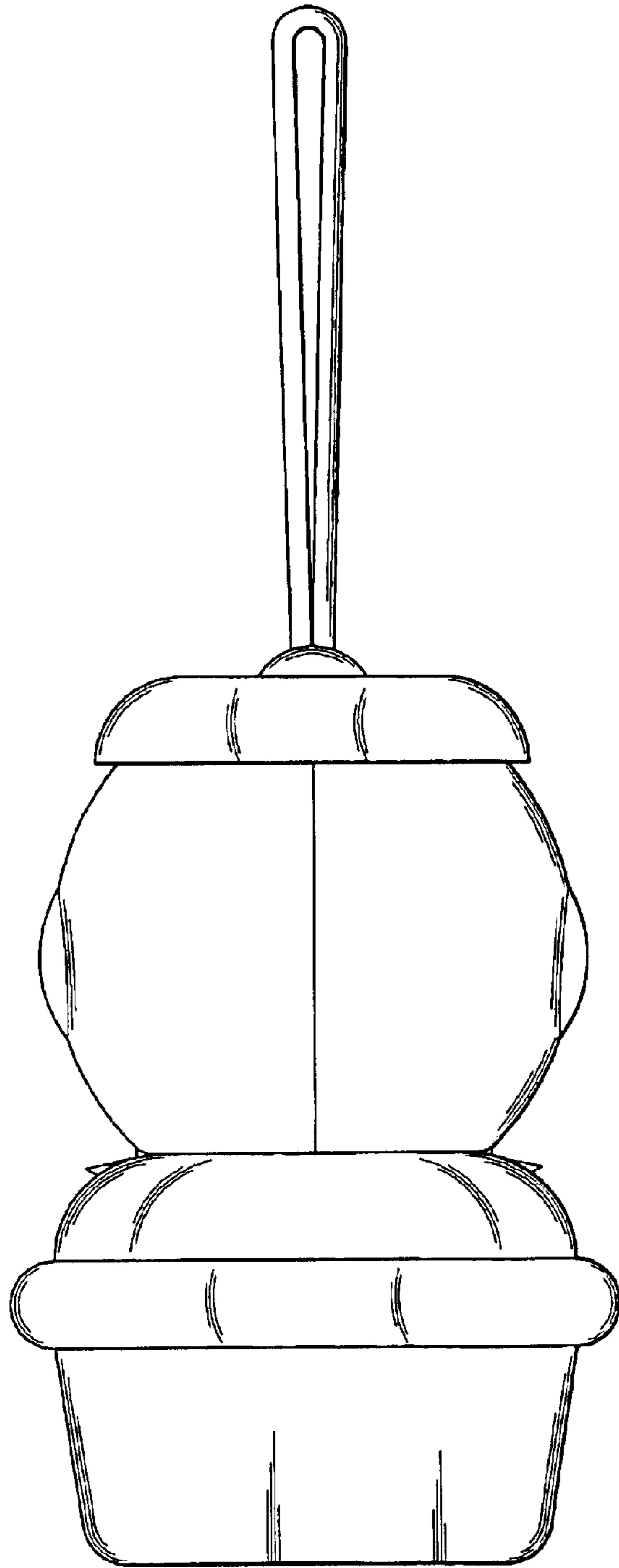

FIG. 3

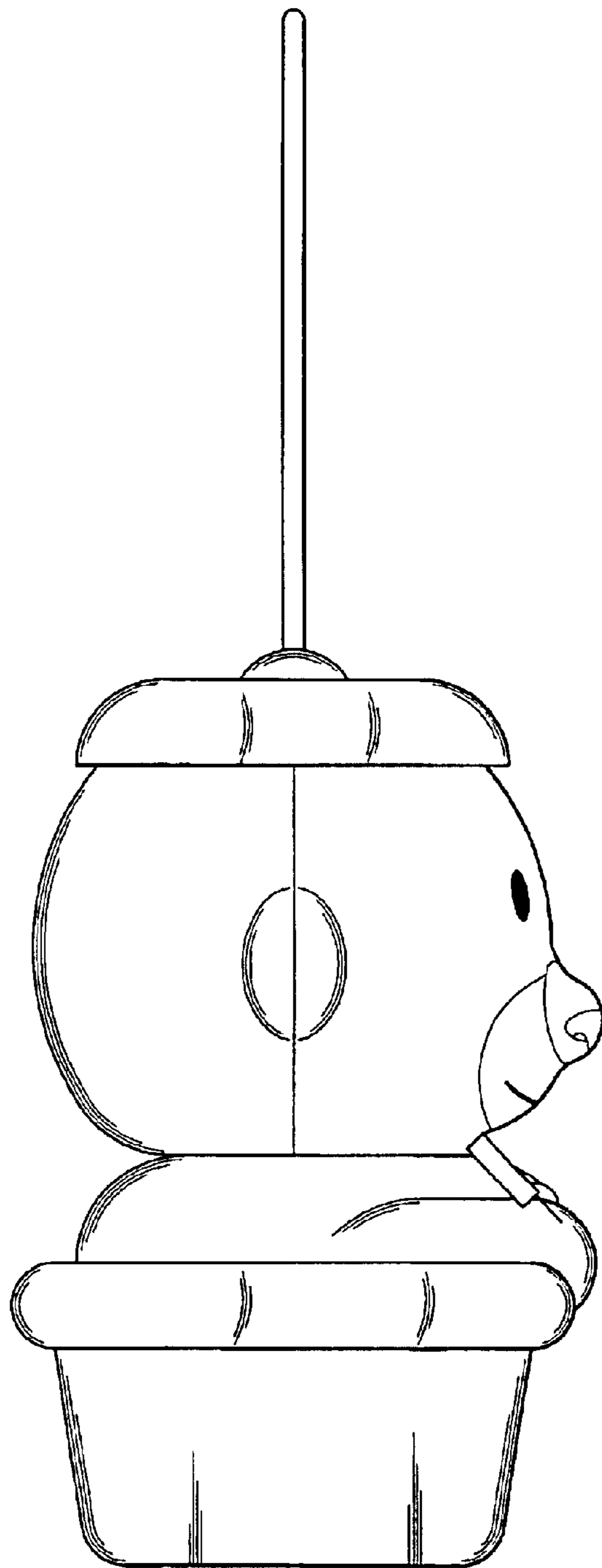

FIG. 4

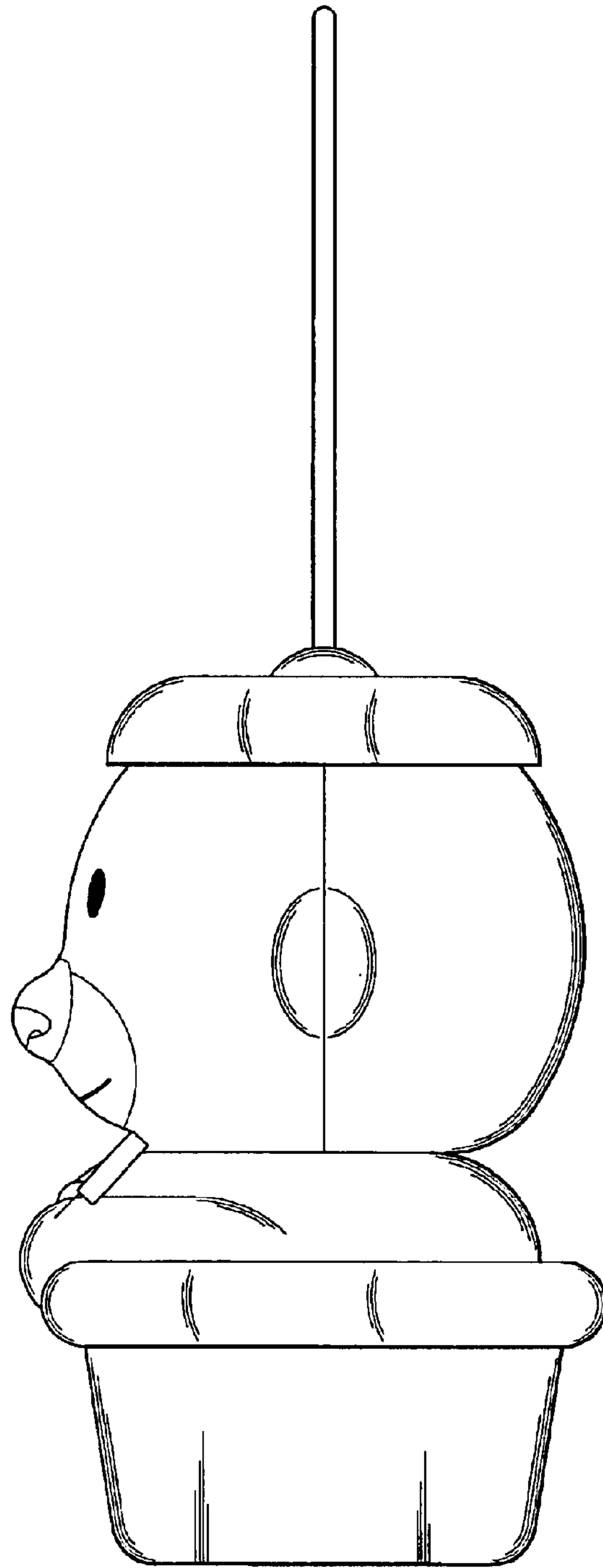

FIG. 5

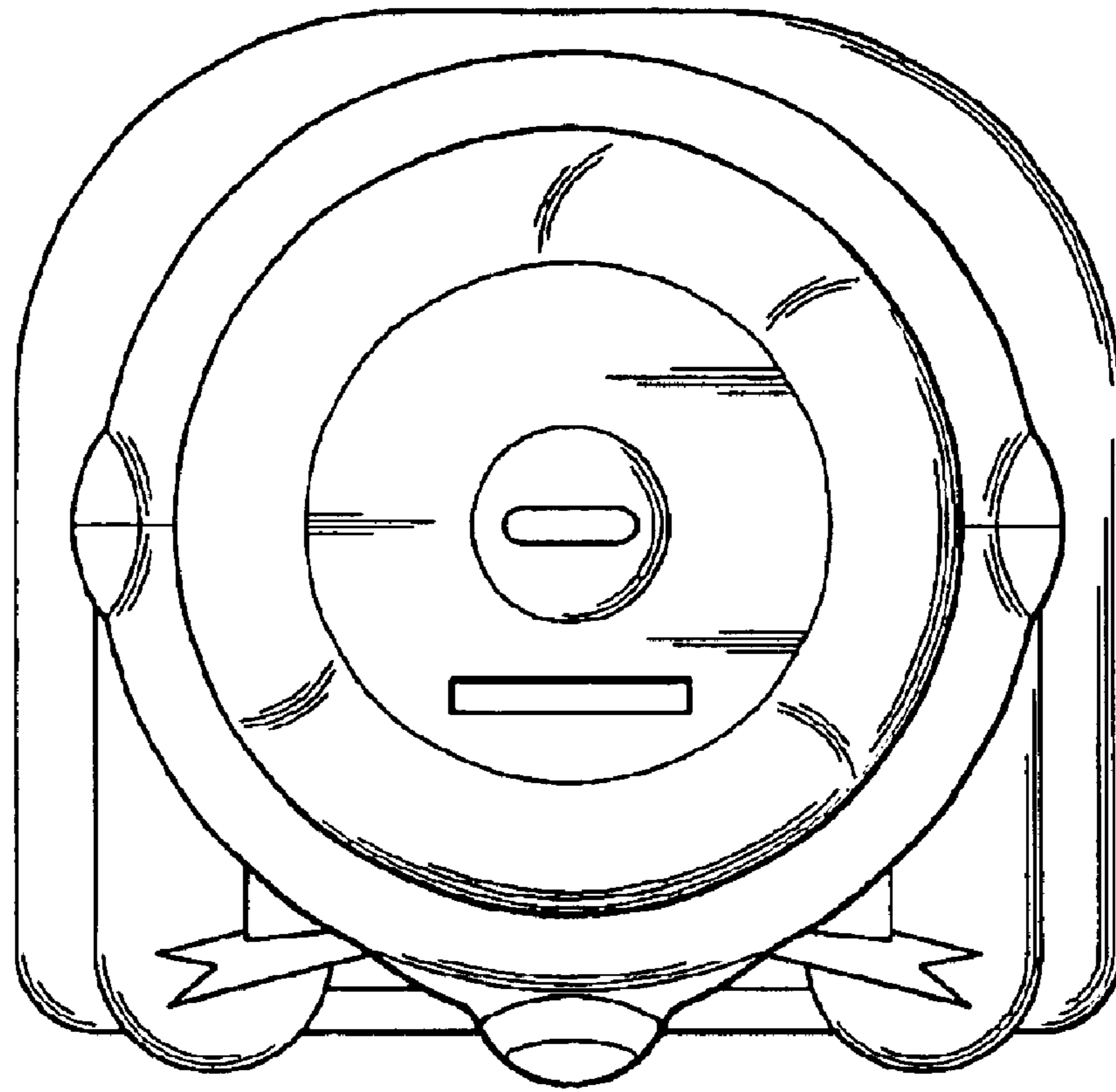

FIG. 6

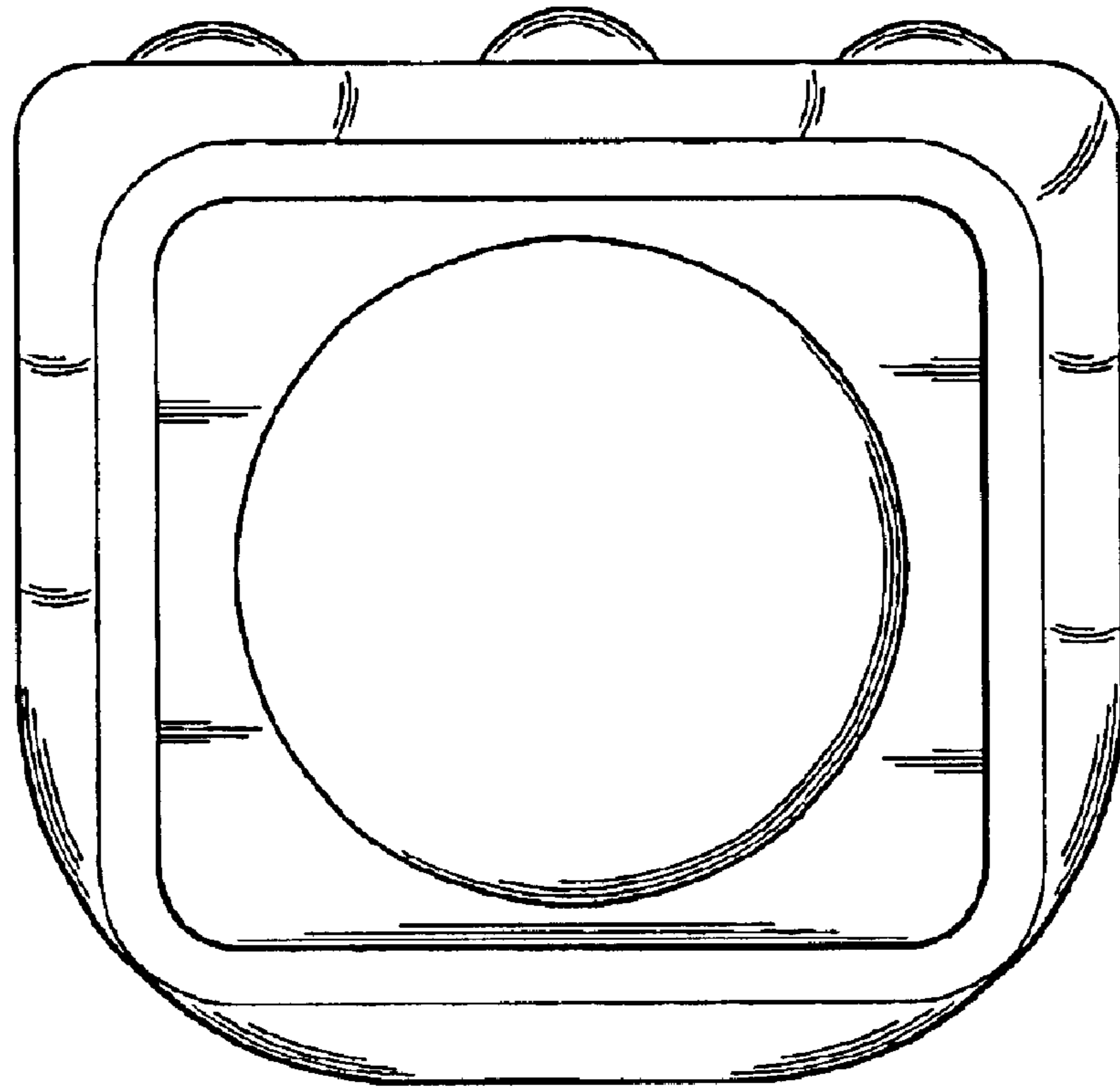

FIG. 7