



US00D504043S

(12) **United States Design Patent**  
**Kennard**

(10) **Patent No.:** **US D504,043 S**  
(45) **Date of Patent:** **\*\* Apr. 19, 2005**

- (54) **BATH ACCESSORY BASE**
- (75) Inventor: **Dan Kennard**, Norcross, GA (US)
- (73) Assignee: **Fusion Hardware Group, Inc.**,  
Norcross, GA (US)
- (\*\*) Term: **14 Years**
- (21) Appl. No.: **29/206,245**
- (22) Filed: **May 28, 2004**
- (51) **LOC (7) Cl.** ..... **23-02**
- (52) **U.S. Cl.** ..... **D6/550**
- (58) **Field of Search** ..... D6/546-550, 518-519,  
D6/522-524; D8/300, 303, 315-321; 108/28-29;  
211/13.1, 16, 60.1, 86.01, 87.01, 88.01,  
88.04, 100, 105.1-105.2, 123, 181.1, 182;  
248/175, 176.1, 251, 302; 16/110.1, 412,  
415; 242/570, 590, 595-598

(56) **References Cited**  
**U.S. PATENT DOCUMENTS**

D431,139 S	*	9/2000	Chen	.....	D6/524
D460,892 S	*	7/2002	Hoernig	.....	D6/546
D463,936 S	*	10/2002	Chen	.....	D6/550
D465,370 S	*	11/2002	Ouyoung	.....	D6/550
D467,109 S	*	12/2002	Yegyayan et al.	.....	D6/550
D470,701 S	*	2/2003	Kuo	.....	D6/550
D476,515 S	*	7/2003	Chen	.....	D6/524
D476,836 S	*	7/2003	Lai	.....	D6/524
D477,486 S	*	7/2003	Green	.....	D6/550
D477,736 S	*	7/2003	Hoernig	.....	D6/546

\* cited by examiner

*Primary Examiner*—Brian N Vinson  
(74) *Attorney, Agent, or Firm*—Troxell Law Office PLLC

(57) **CLAIM**

The ornamental design for bath accessory base, as show and described.

**DESCRIPTION**

FIG. 1 is a top, front, and left side perspective view of a bath accessory base showing my new design;  
 FIG. 2 is a left side elevational view thereof;  
 FIG. 3 is a right side elevational view thereof;  
 FIG. 4 is a rear elevational view thereof,  
 FIG. 5 is a front elevational view thereof;  
 FIG. 6 is a top plan view thereof;  
 FIG. 7 is a bottom plan view thereof;  
 FIG. 8 is a top, front, and left side perspective view thereof, showing a broken-line representation of an alternative mounting environment;  
 FIG. 9 is a reduced top, front, and left side perspective view thereof, showing a broken-line representation of another alternative mounting environment;  
 FIG. 10 is a reduced top, front, and left side perspective view thereof, showing a broken-line representation of another alternative mounting environment; and,  
 FIG. 11 is a reduced top, front, and left side perspective view of a second embodiment of a bath accessory base thereof.  
 The broken-line disclosure in the views is for illustrative purposes only and forms no part of the claimed design.

**1 Claim, 8 Drawing Sheets**

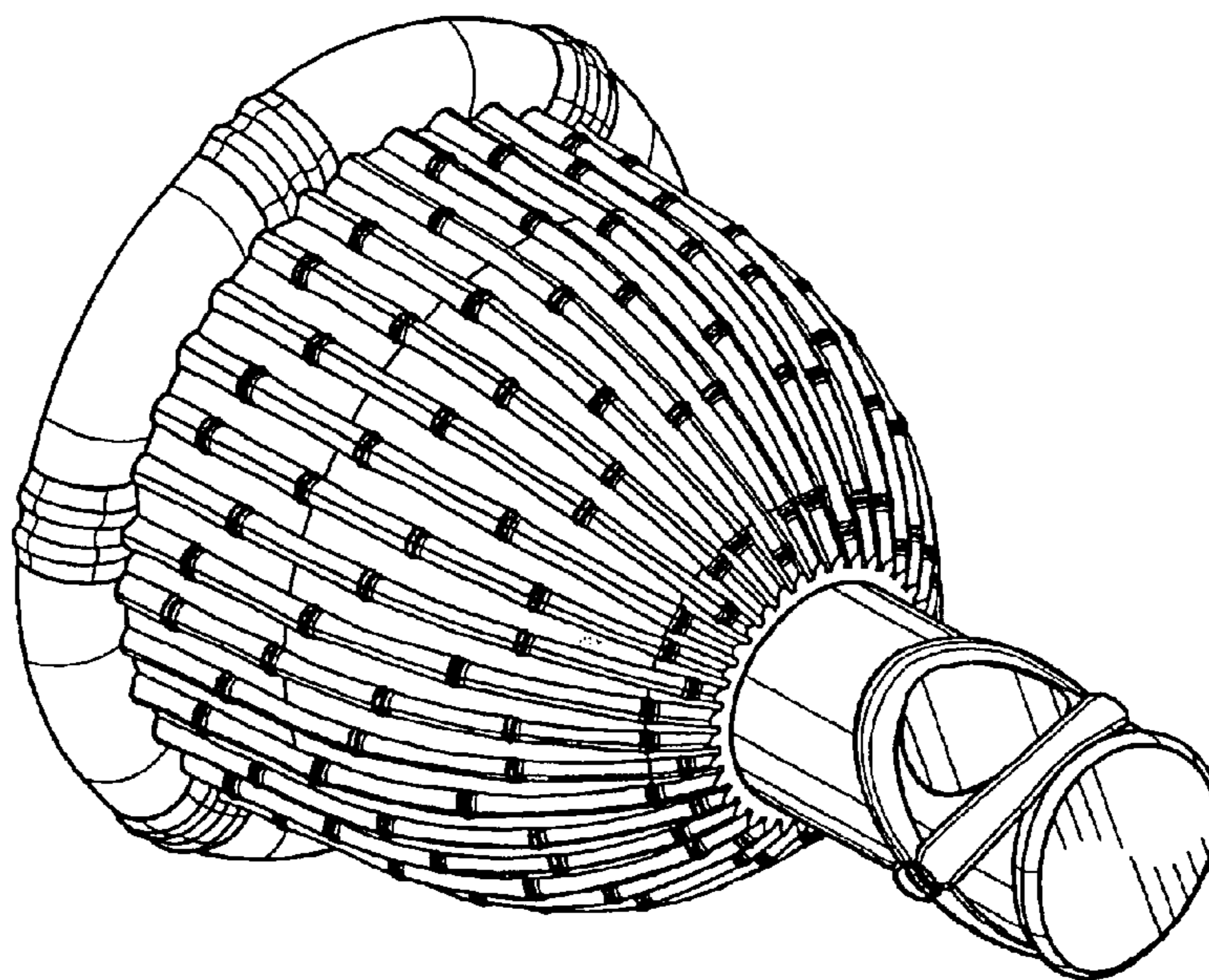

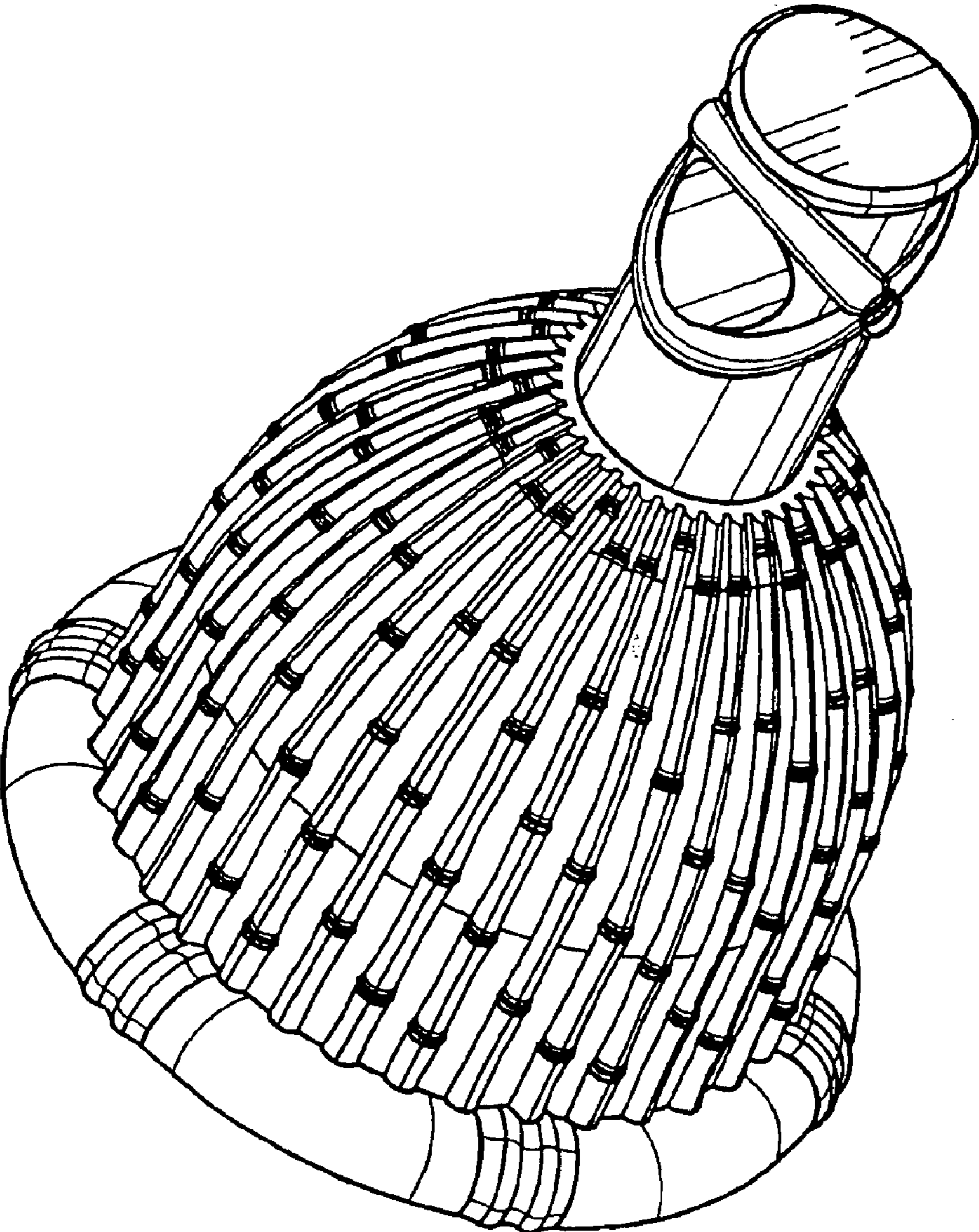

FIG. 1



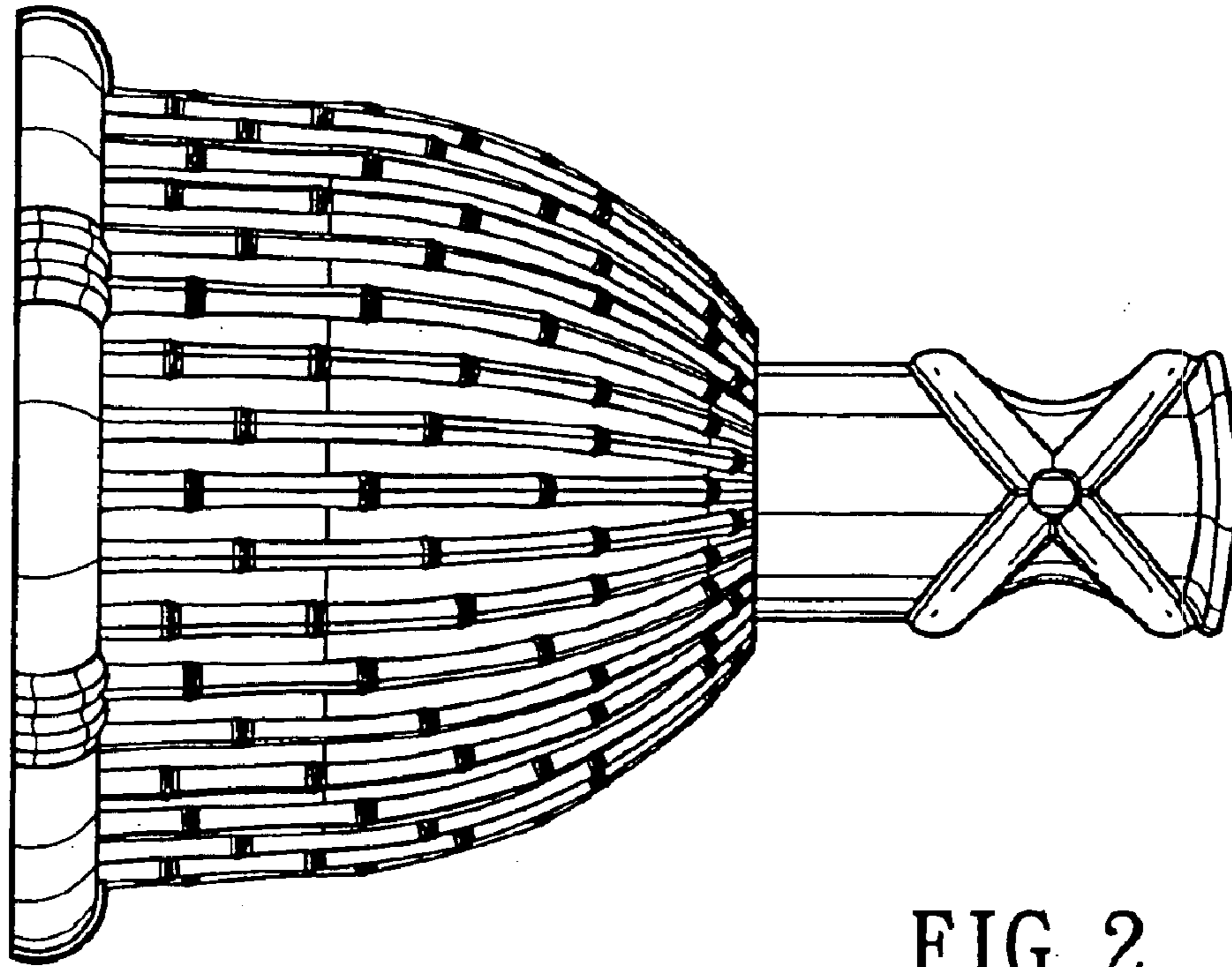

FIG. 2

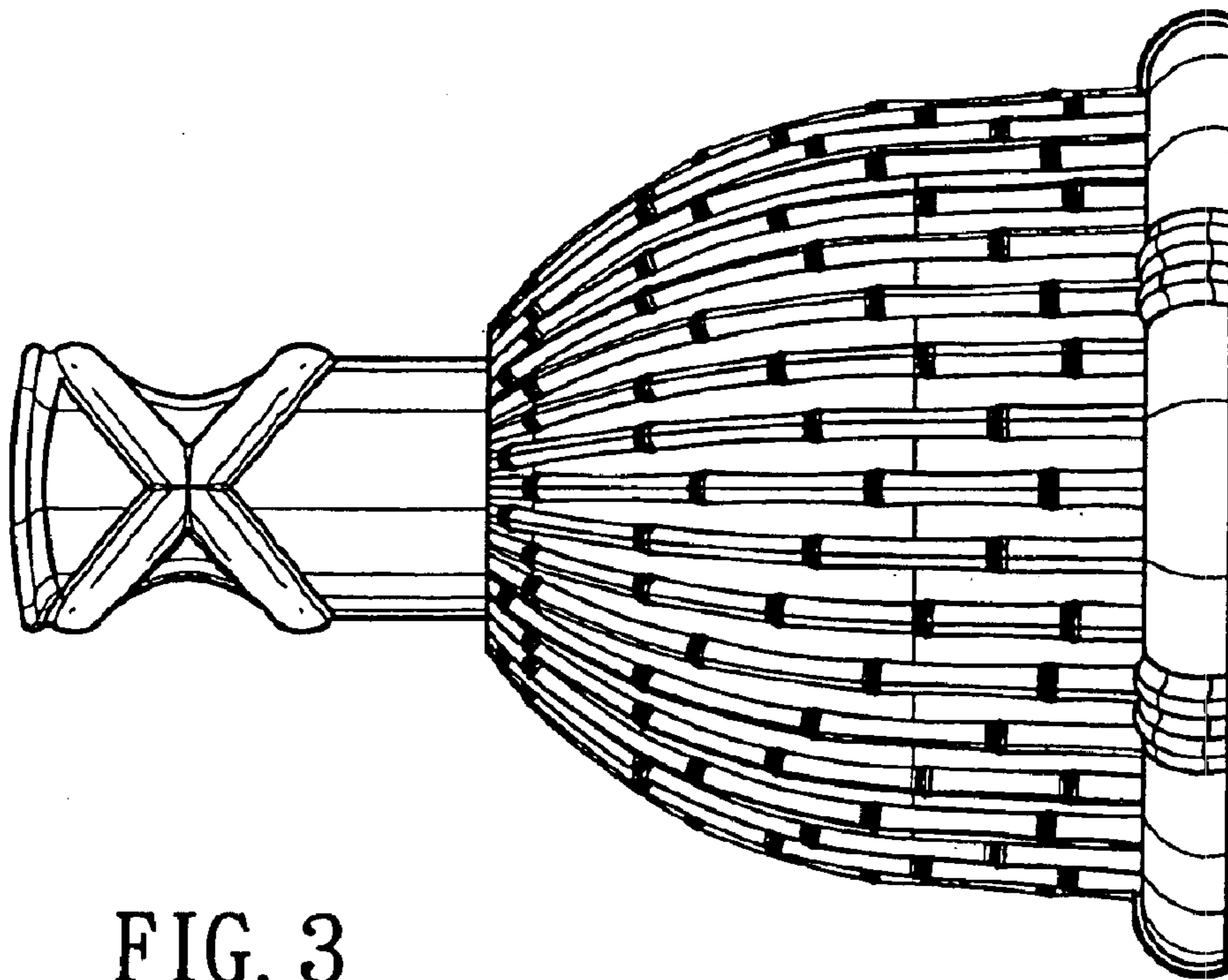

FIG. 3

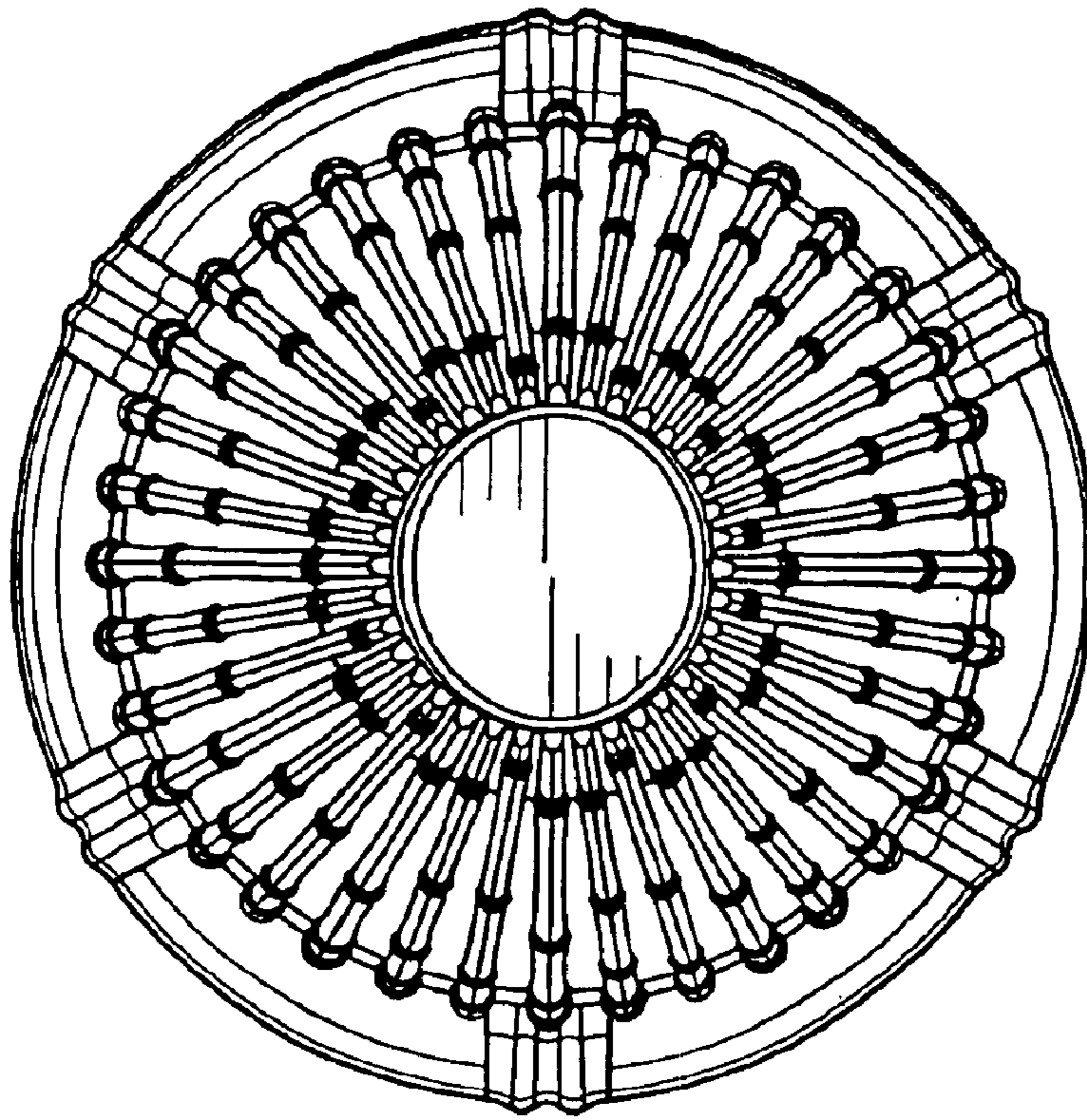

FIG. 5

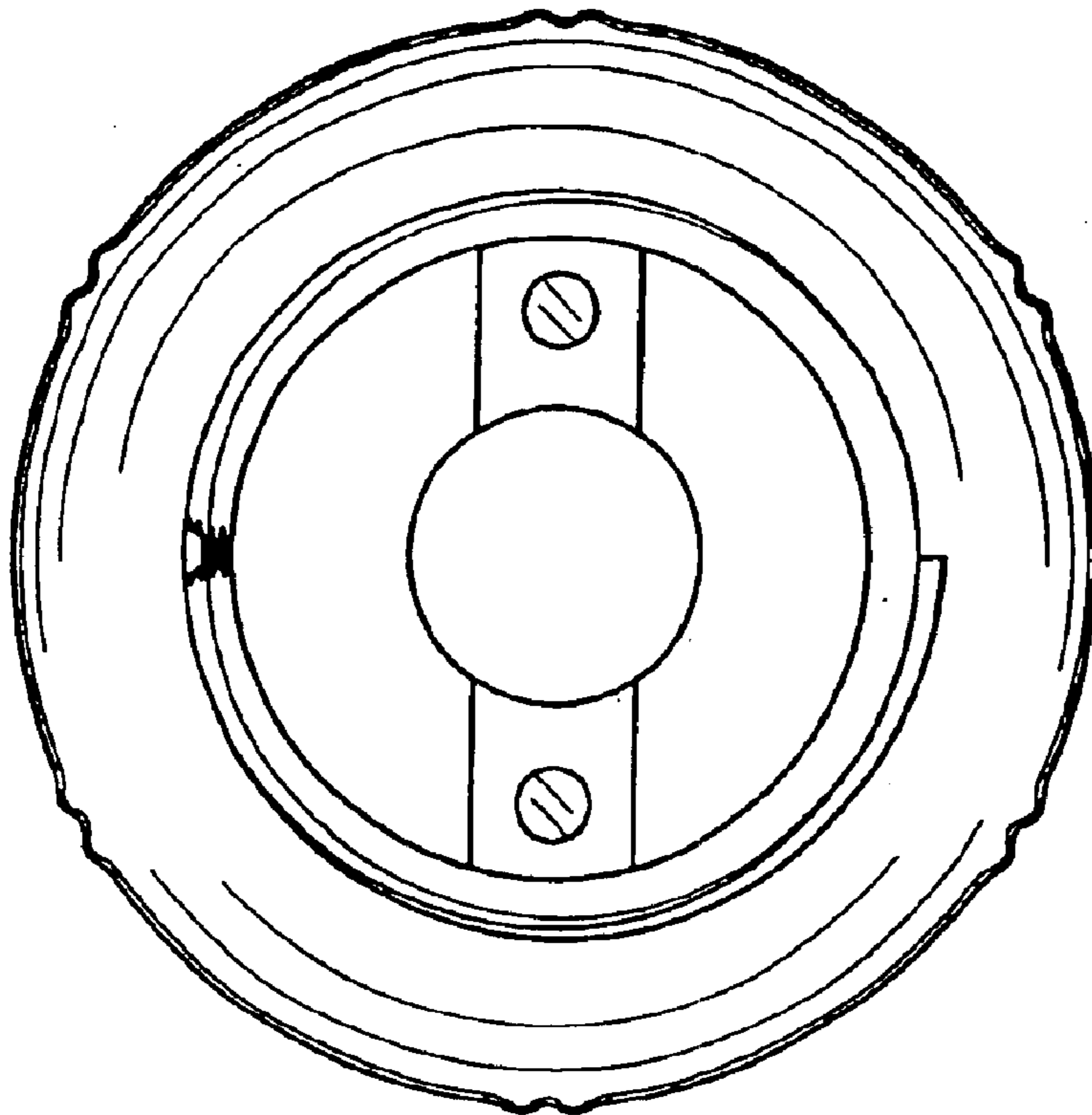

FIG. 4

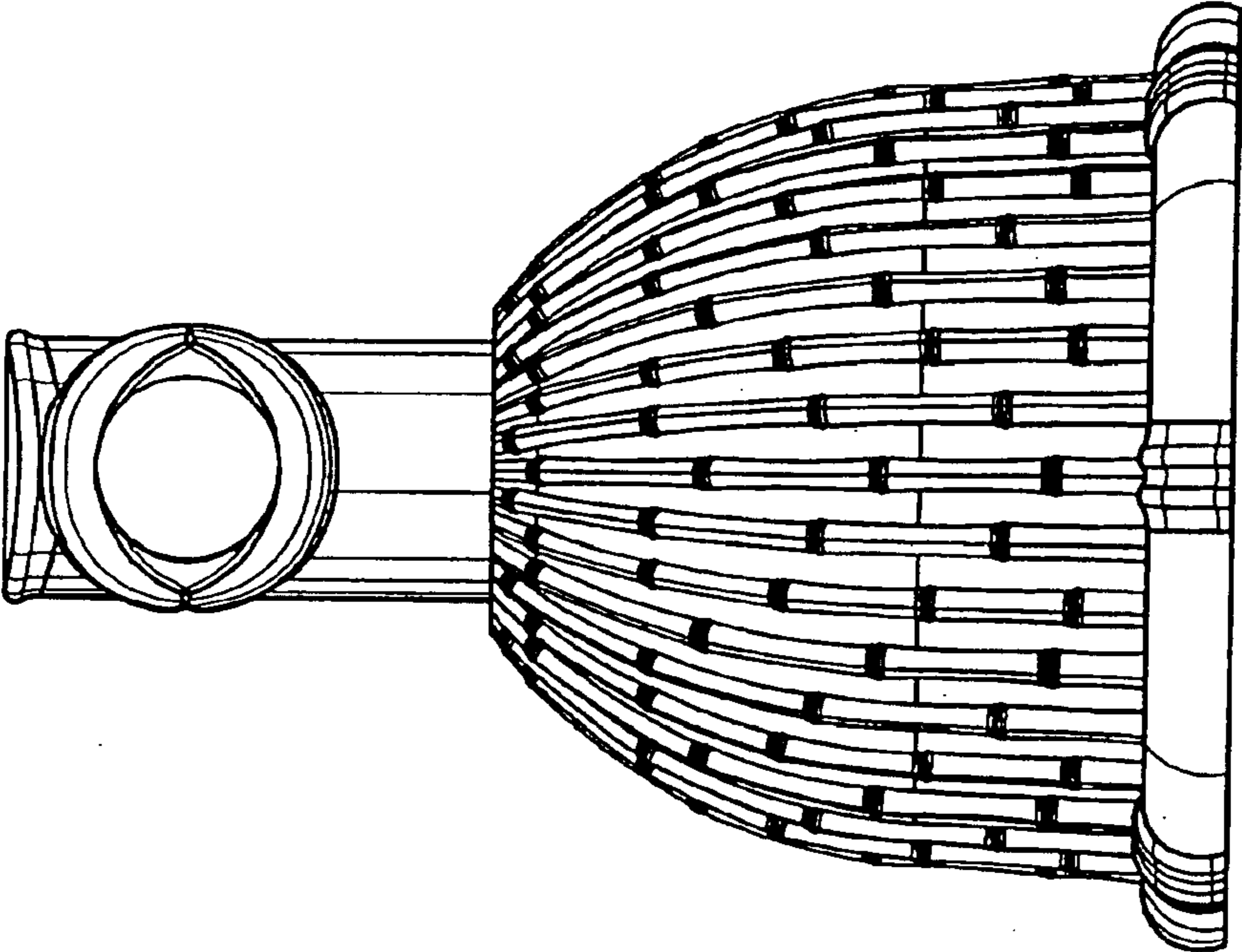

FIG. 7

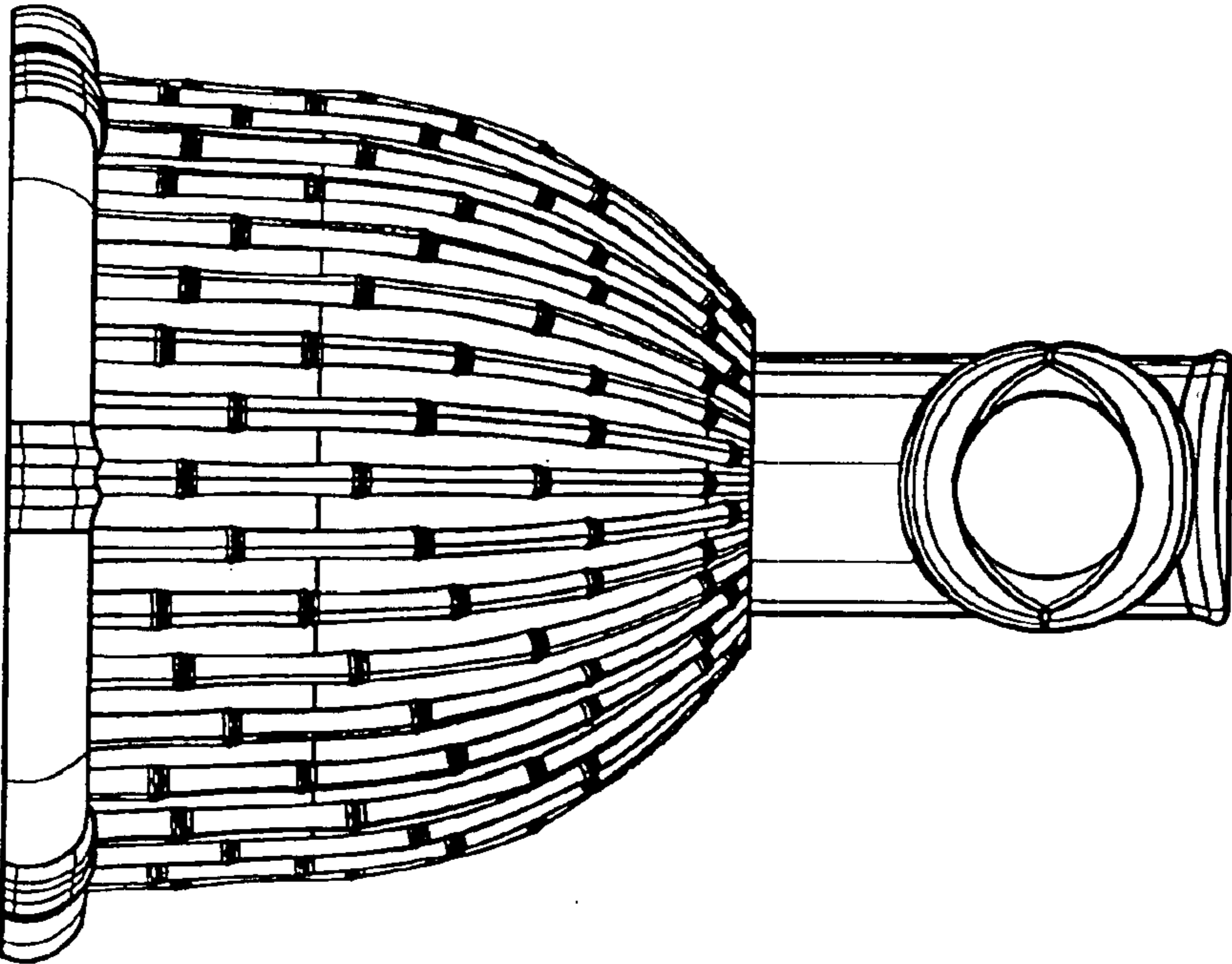

FIG. 6



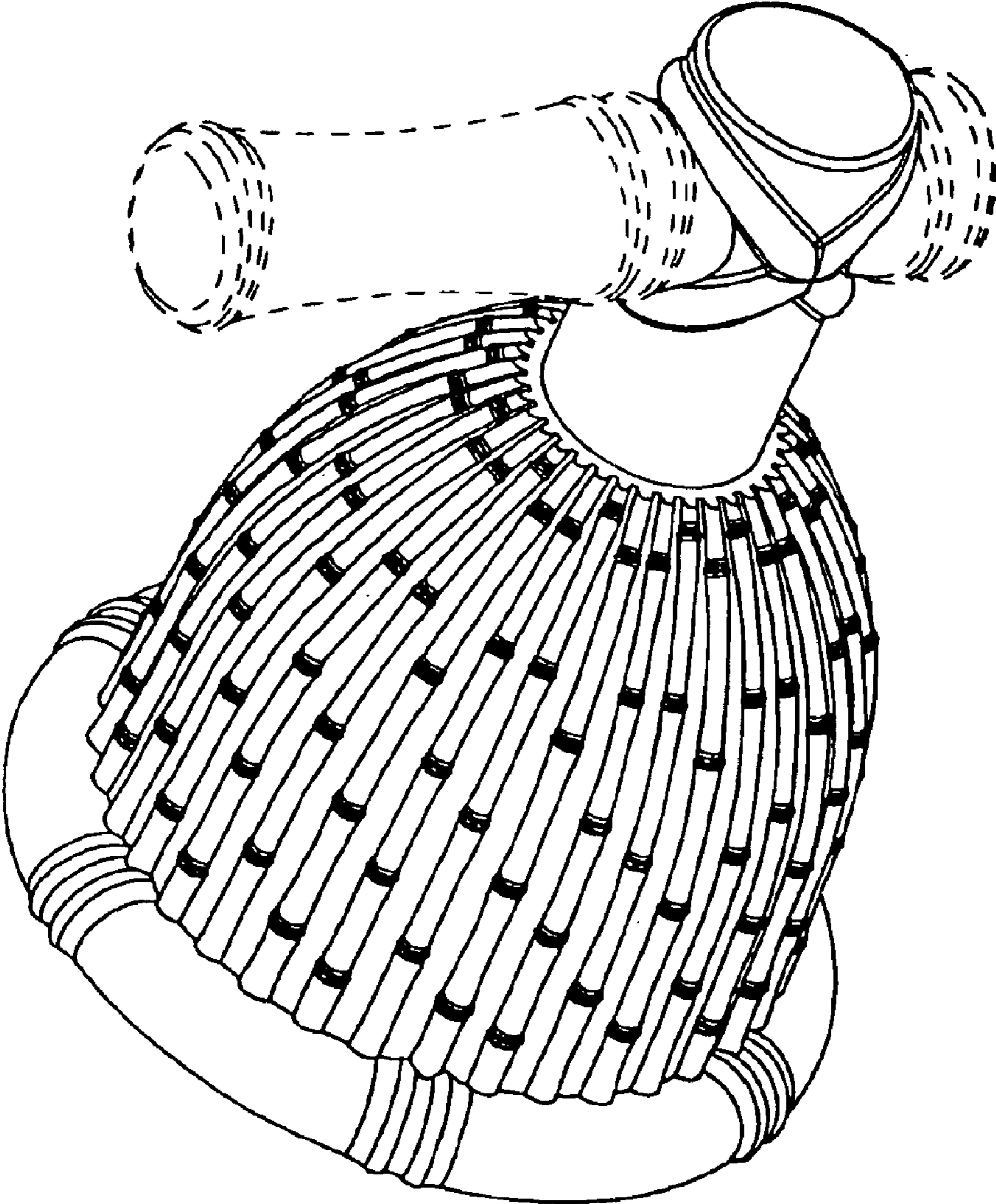

FIG. 8

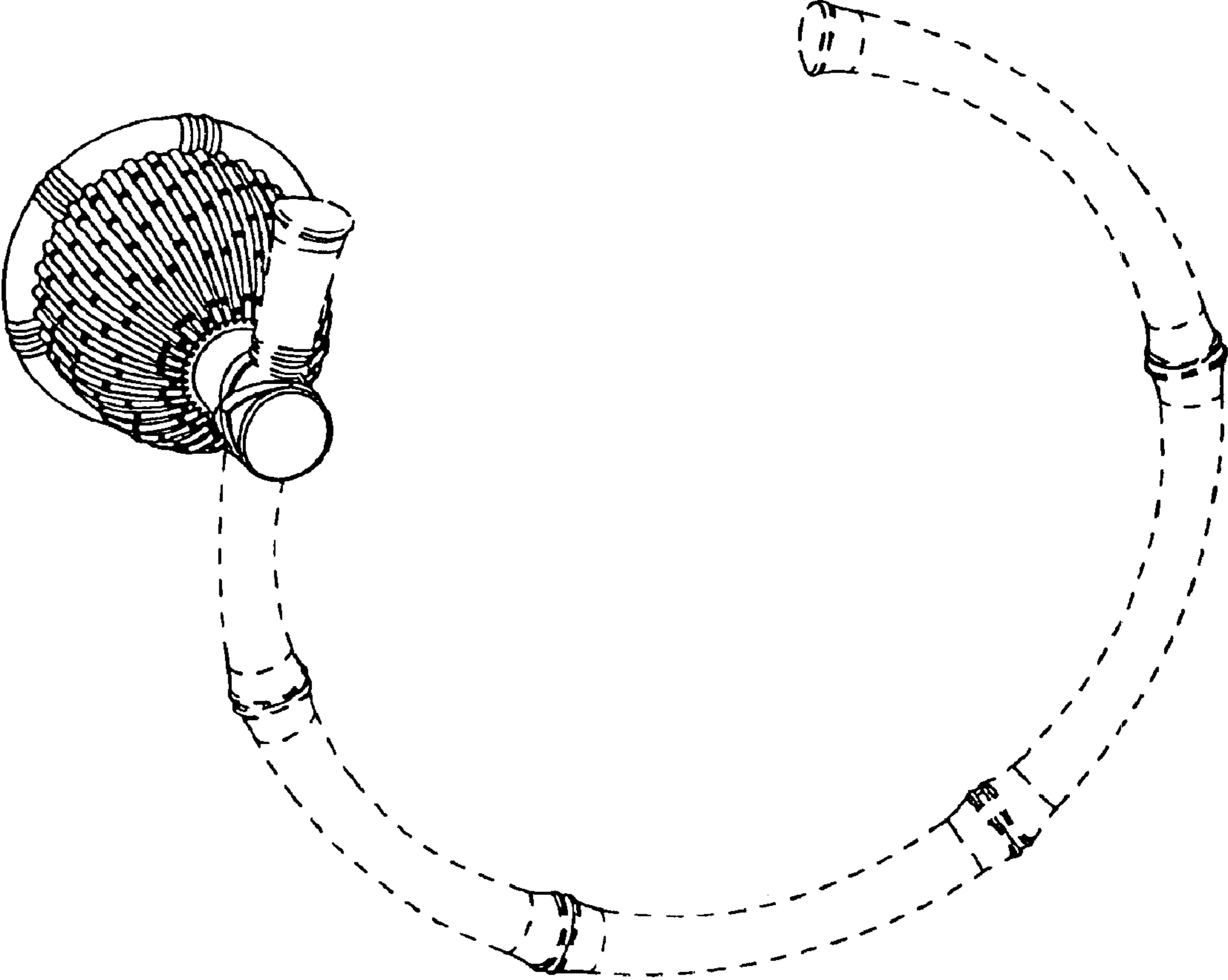

FIG. 9

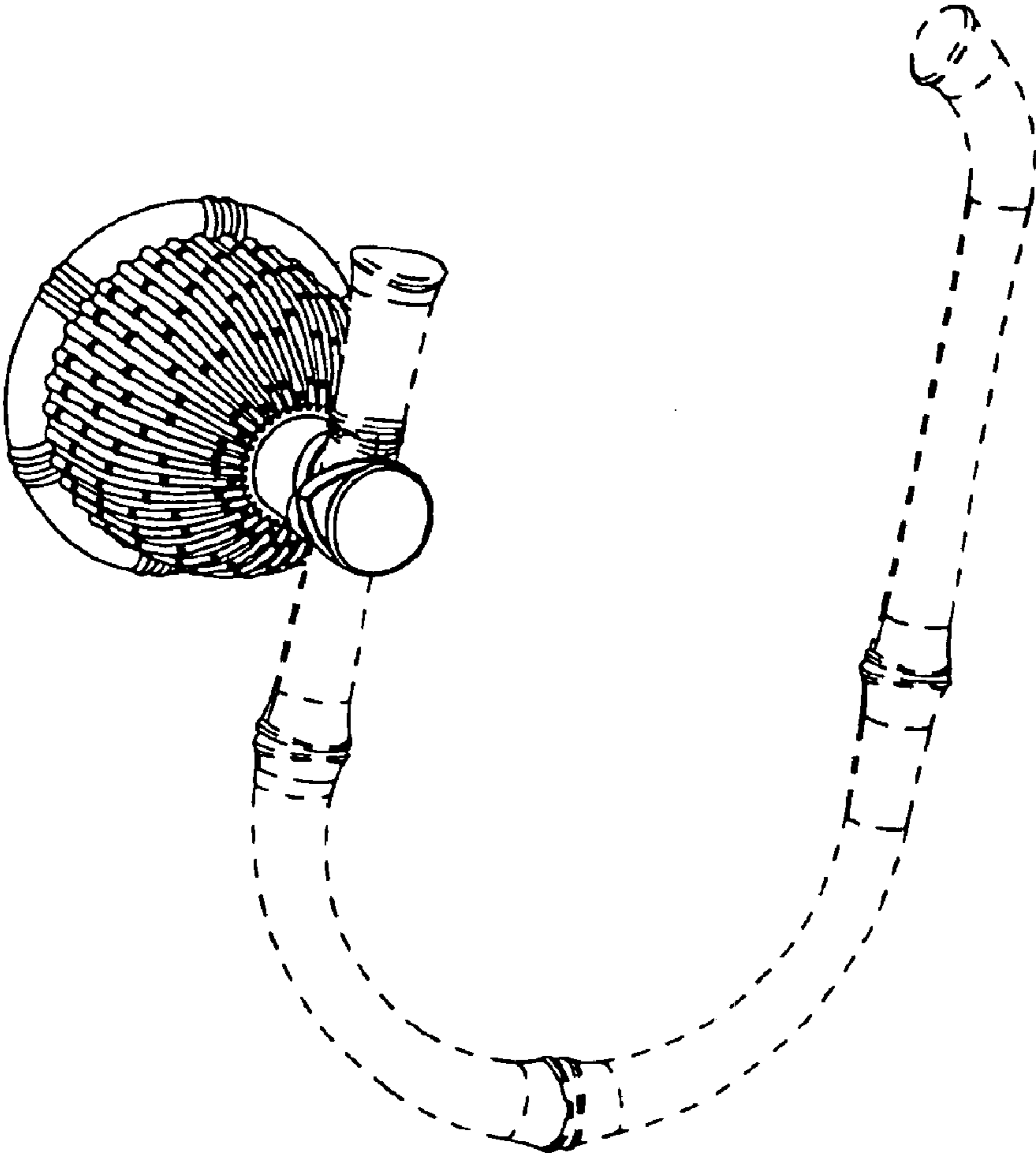

FIG. 10



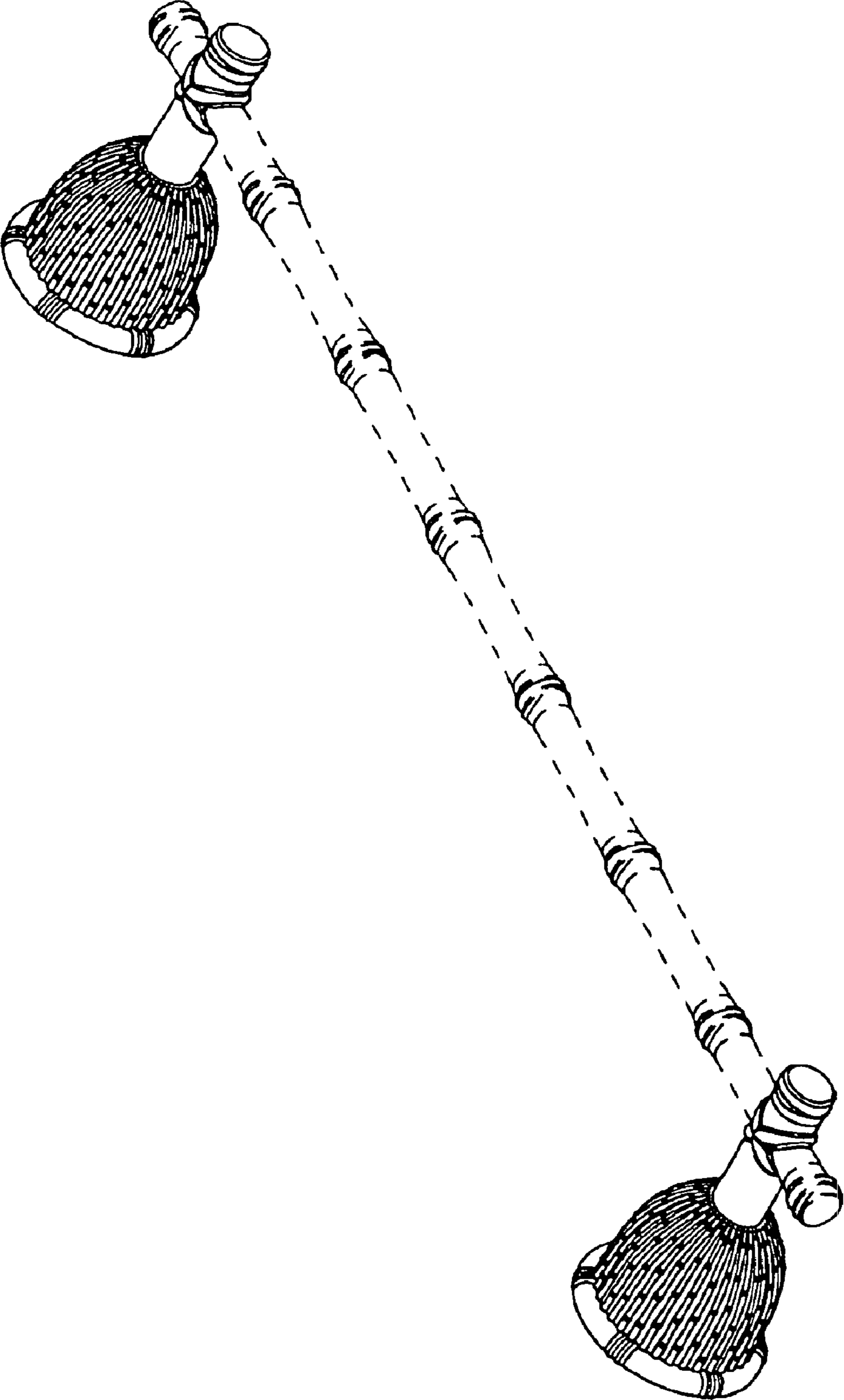

FIG. 11