

US00D503929S

(12) **United States Design Patent** (10) **Patent No.:** **US D503,929 S**
Akinrele et al. (45) **Date of Patent:** **** Apr. 12, 2005**

(54) **DIMMER CONTROL SYSTEM**

(75) Inventors: **Dylan Akinrele**, Leonia, NJ (US);
Benjamin Reed Dewinter, Brooklyn,
NY (US); **Richard Whitehall**, New
York, NY (US); **Erik Gouhl**, Islip, NY
(US)

(73) Assignee: **Cooper Wiring Devices, Inc.**,
Peachtree City, GA (US)

(**) Term: **14 Years**

(21) Appl. No.: **29/180,531**

(22) Filed: **Apr. 26, 2003**

(51) **LOC (7) Cl.** **13-03**

(52) **U.S. Cl.** **D13/171; D13/177**

(58) **Field of Search** D13/169, 170,
D13/174, 177; D8/350-353; 174/48, 52.1,
66, 55; 200/59, 5 R, 16 R, 42.01, 237,
241, 293, 296, 297, 308, 310, 313-314,
324, 329, 331, 341, 519, 547, 531, 536,
541, 550, 571; 315/129, 136, 291, 307,
312, 362; 361/622, 643

(56) **References Cited**

U.S. PATENT DOCUMENTS

4,649,323 A	3/1987	Pearlman et al.	
5,017,837 A	5/1991	Hanna et al.	
5,248,919 A	9/1993	Hanna et al.	
5,336,979 A	8/1994	Watson et al.	
5,399,940 A	3/1995	Hanna et al.	
D376,130 S	* 12/1996	Elwell et al. D13/158
5,637,930 A	6/1997	Rowen et al.	
5,895,888 A	* 4/1999	Arenas et al. 174/66
6,005,308 A	12/1999	Bryde et al.	
D477,575 S	* 7/2003	Mayo et al. D13/171
D482,007 S	* 11/2003	Mayo et al. D13/171

OTHER PUBLICATIONS

Lutron product brochure for “Maestro the High-Tech Multi-
Location Dimmer”, pp. 56-59.
Lutron product brochure for “FAEDRA Smart Dimmer—
For Standard Wallplate”, Lutron Electronics Co., Inc. (2002).

Lutron Ordering Guide for “FAEDRA Smart Dimmer—For
Standard Wallplate”, Lutron Electronics Co., Inc. (2002).
Product Specification Sheets for Onset Low-Wattage Incan-
descent Dimmer, Lightoller Controls (1997).
Ordering Guide for Onset digital dimmers and controls, pp.
10-11, Lightolier Control (1997).
Product Specification Sheet for Onset Channel Remote,
Lightolier Controls (1997).
Product Brochure for The Mural Collection, Leviton Manu-
facturing Co., Inc. (2000).
Product Specifications for Mural Lighting Controls, Leviton
Manufacturing Co., Inc. (1999).
Product Specifications for Mural Level Set (L/S) Lighting
Controls, Leviton Manufacturing Co., Inc. (2000).

* cited by examiner

Primary Examiner—Philip S. Hyder
Assistant Examiner—Selina Sikder
(74) *Attorney, Agent, or Firm*—Ostrager Chong Flaherty &
Broitman P.C.

(57) **CLAIM**

The ornamental design for a dimmer control system, as
shown and described.

DESCRIPTION

FIG. 1 is a front and right side perspective view of the
design.
FIG. 2 is a front view thereof.
FIG. 3 is a right side view thereof.
FIG. 4 is a top plan view thereof (the bottom being a mirror
image thereof).
FIG. 5 is a left side view thereof.
FIG. 6 is a front and right side perspective view of another
embodiment of the design.
FIG. 7 is a front view thereof.
FIG. 8 is a right side view thereof.
FIG. 9 is a top plan view thereof (the bottom being a mirror
image thereof); and,
FIG. 10 is a left side view thereof.
In all of the views, the dotted lines are for environmental
purposes only and form no part of the claimed design. The
rear is not part of the claimed design.

1 Claim, 6 Drawing Sheets

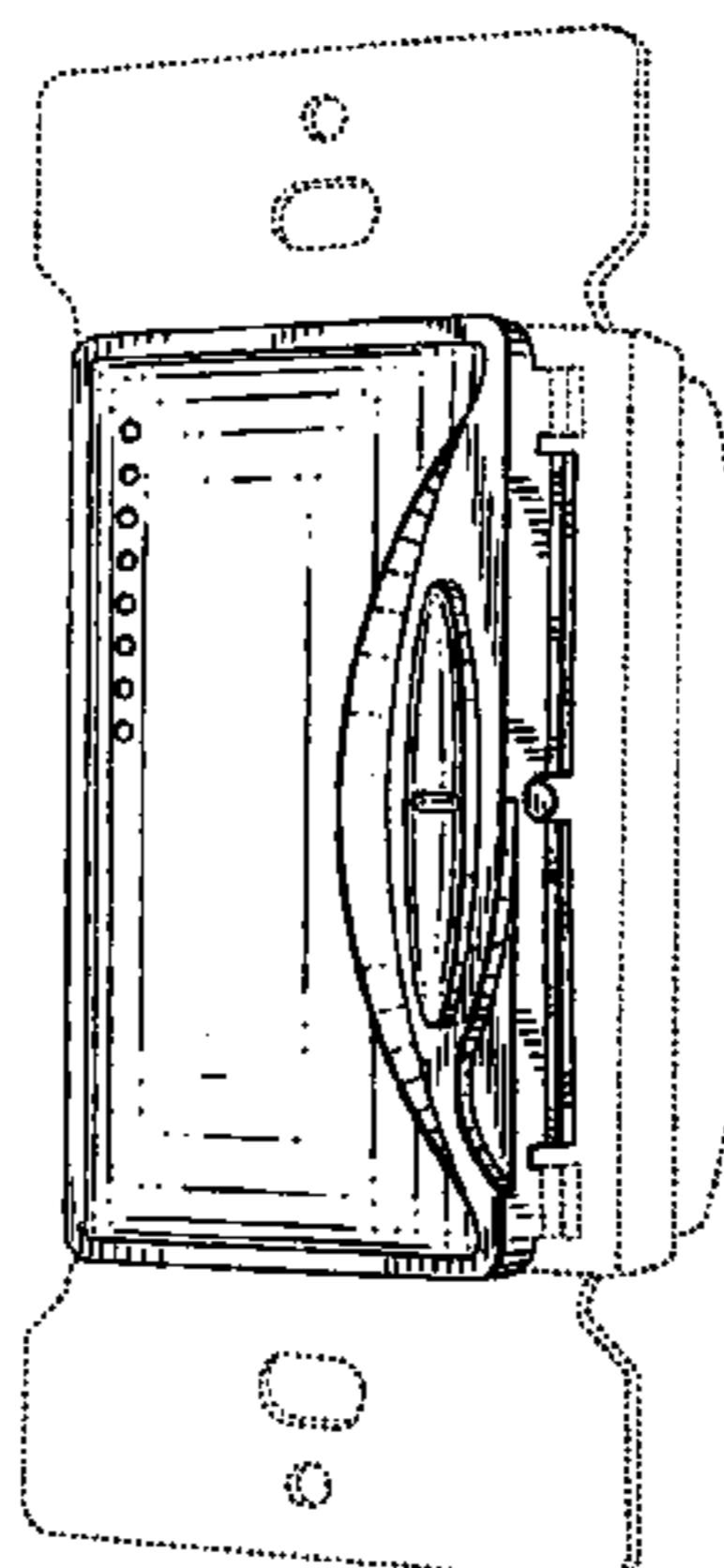

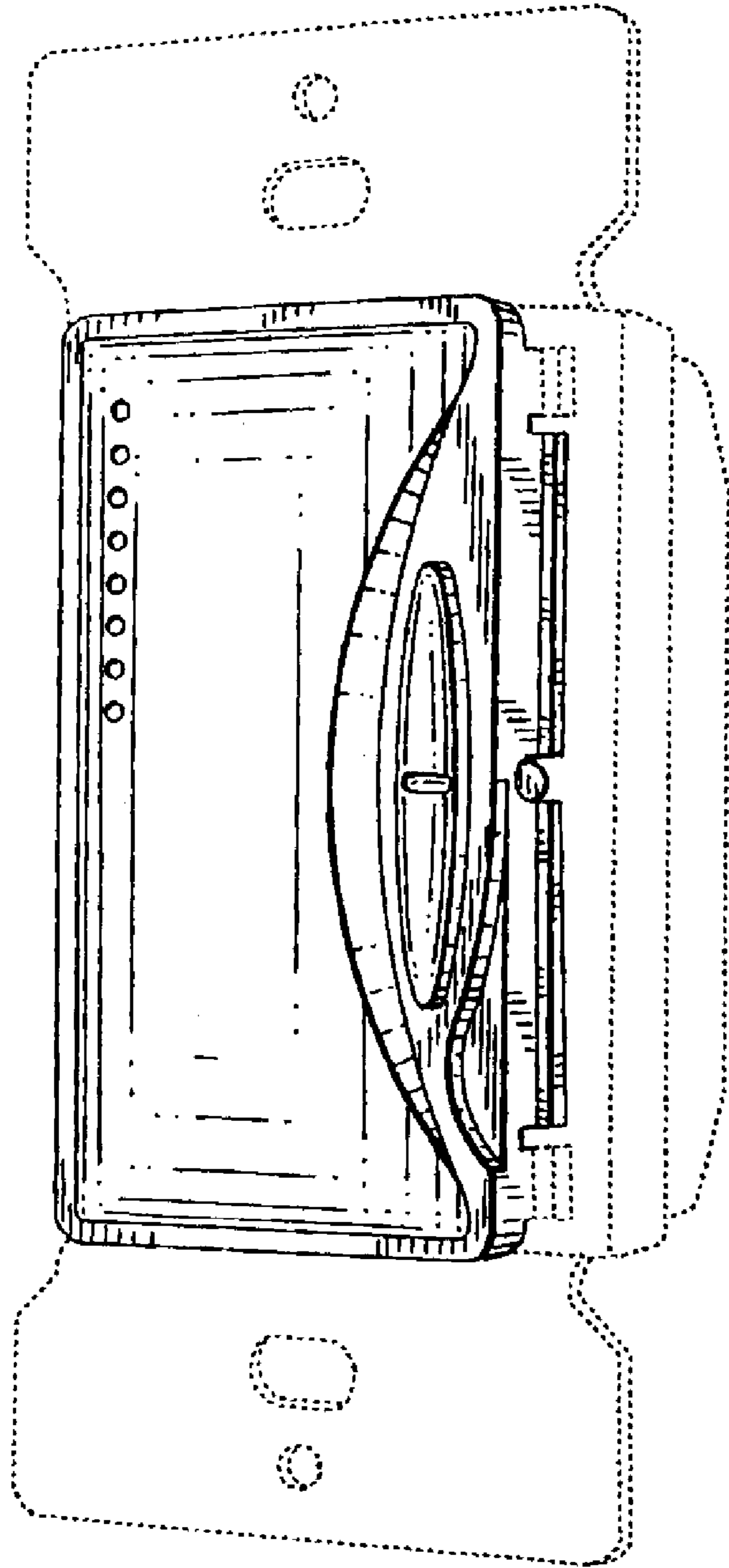

FIG. 1

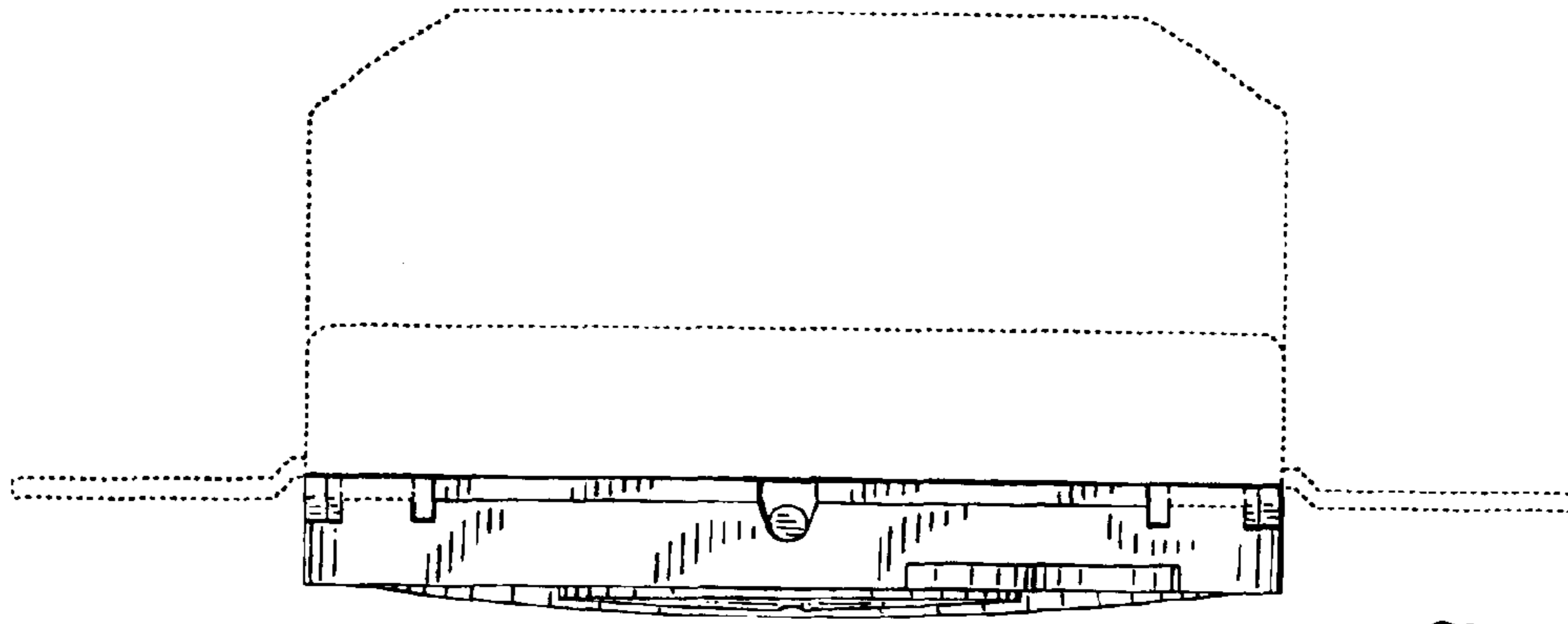

FIG. 3

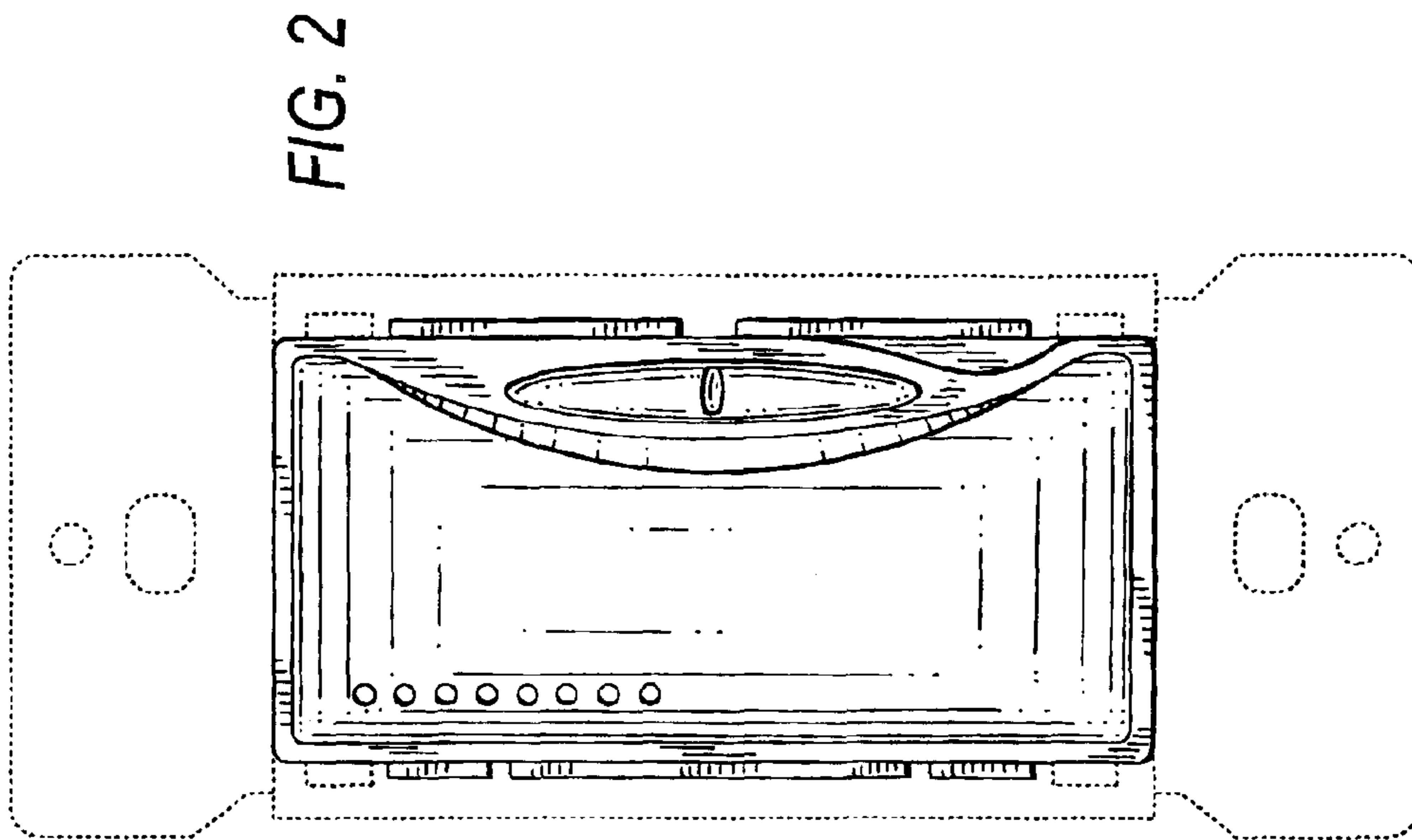

FIG. 2

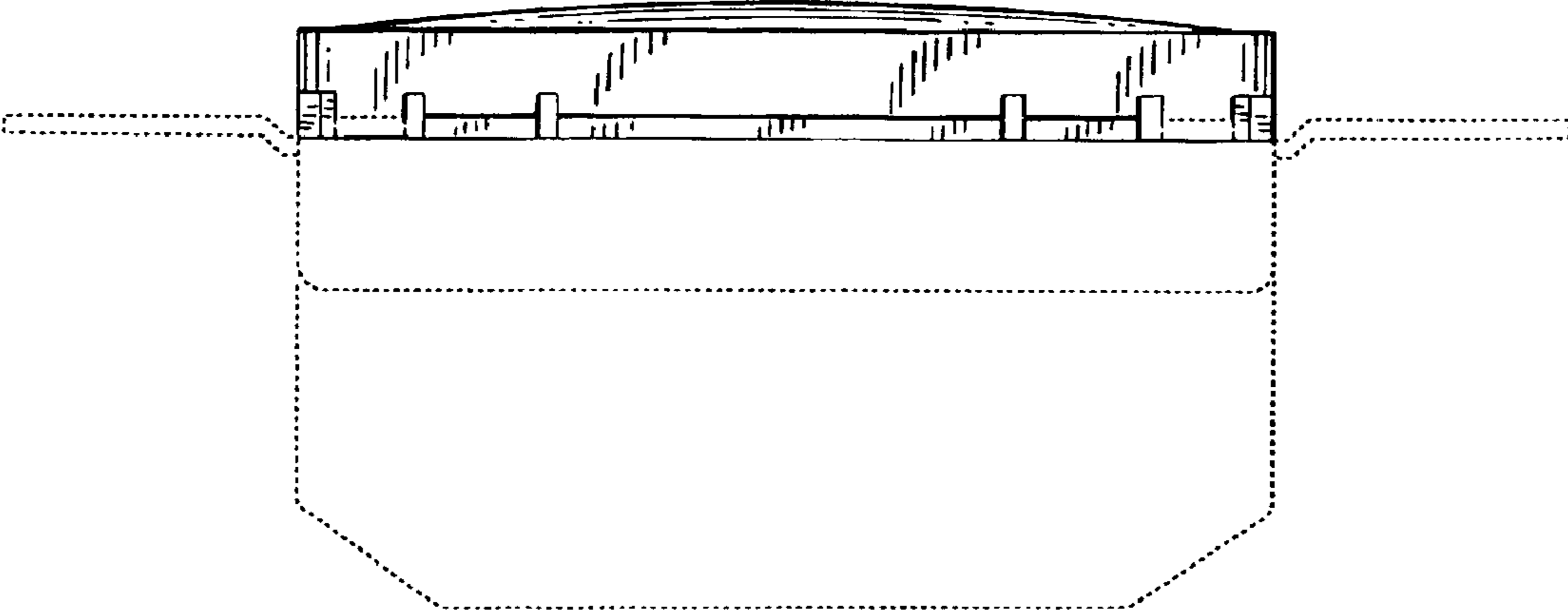

FIG. 5

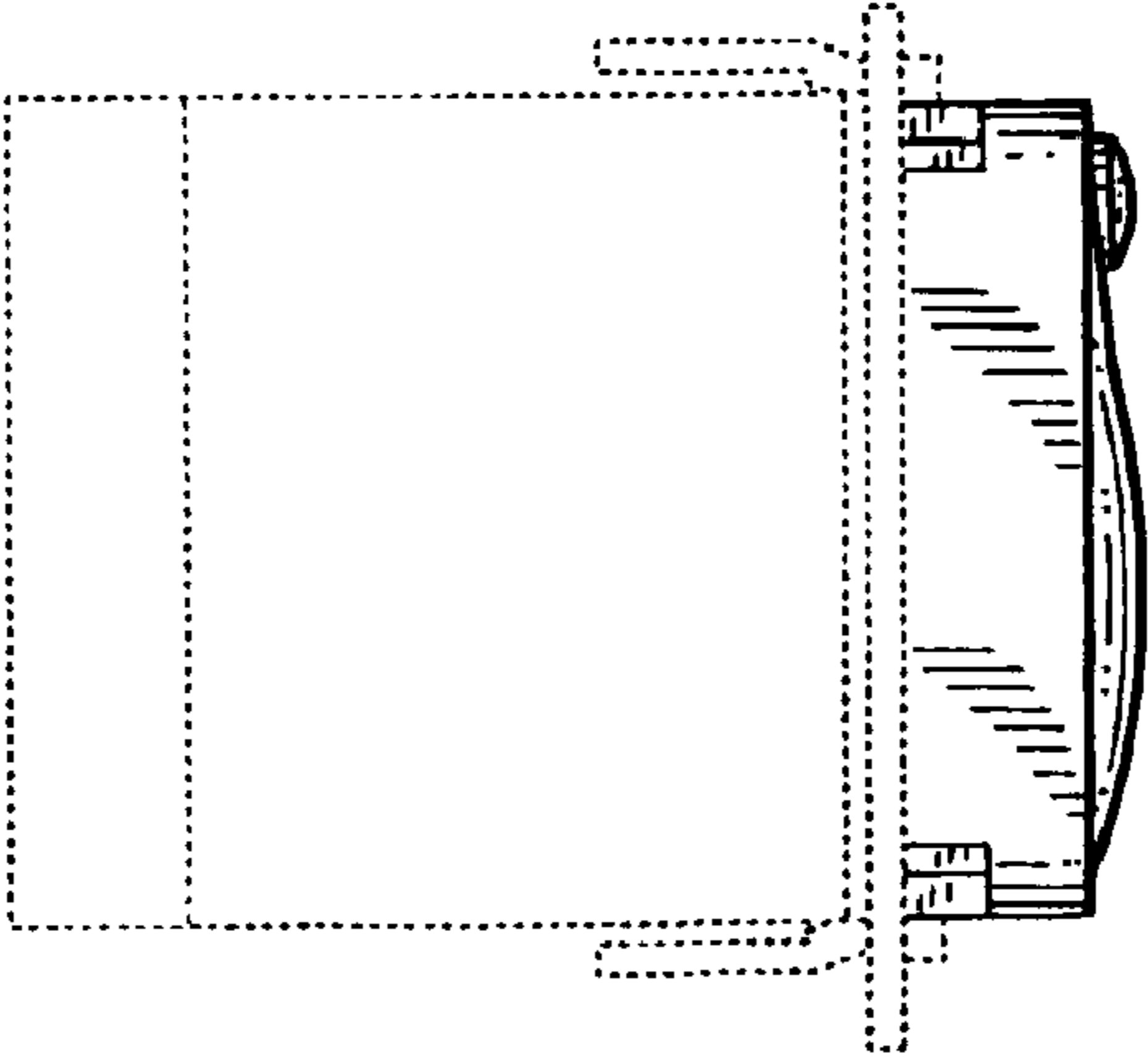

FIG. 4

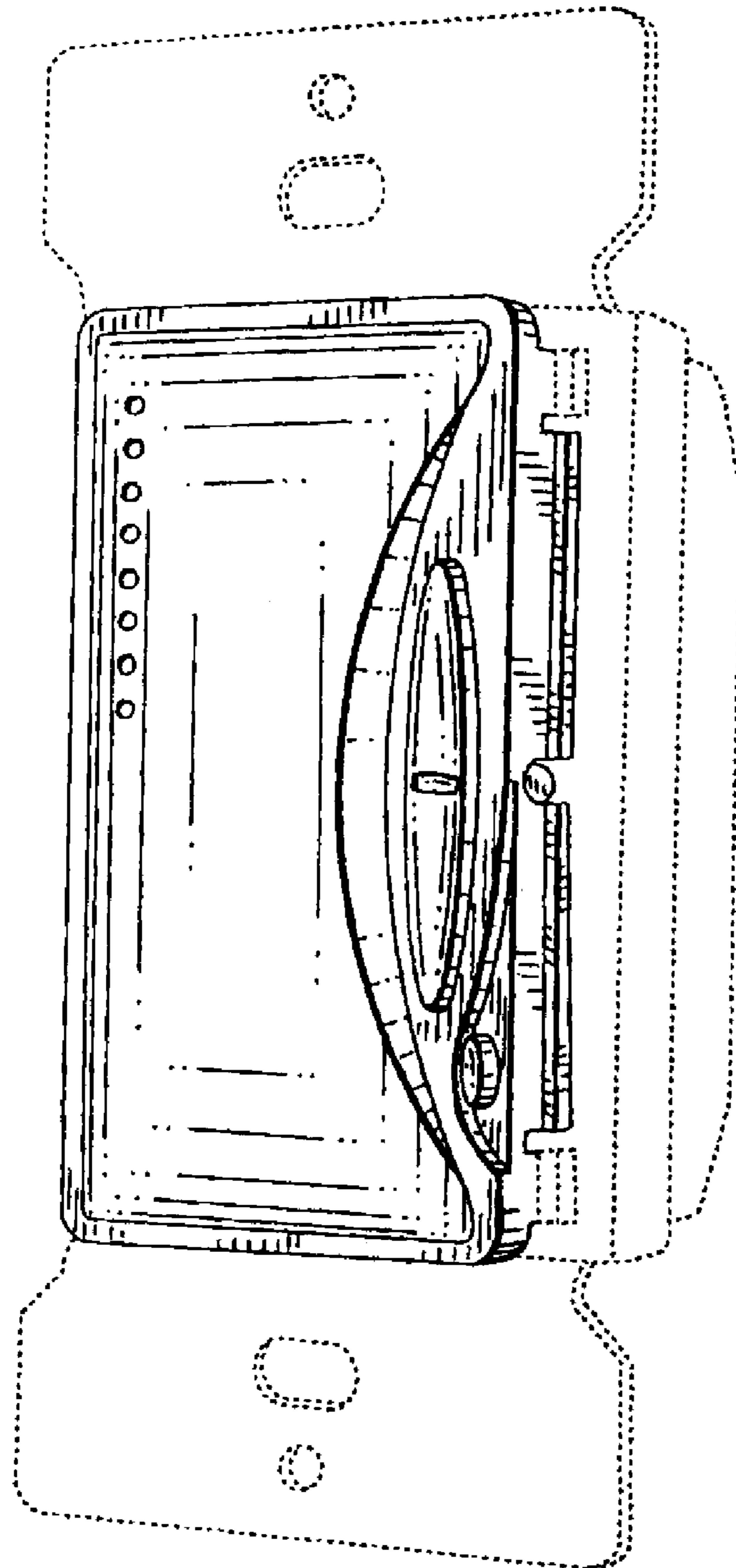

FIG. 6

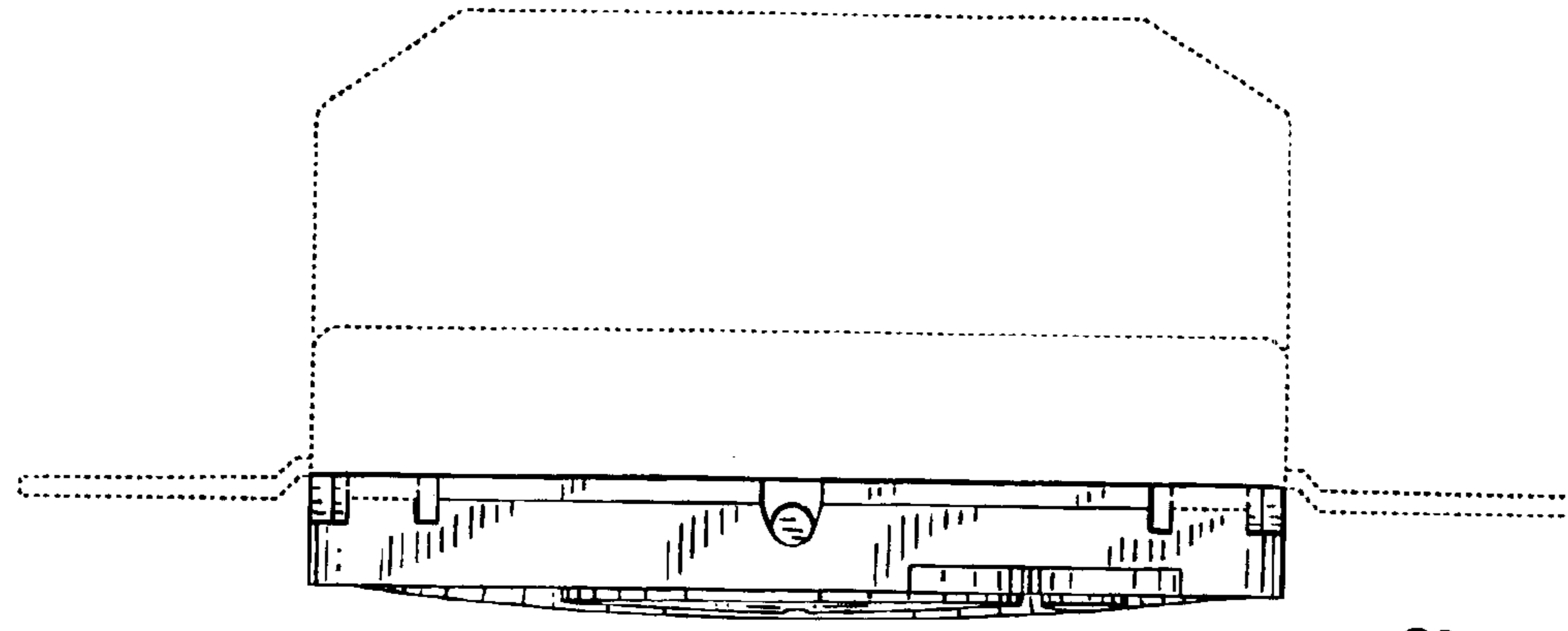

FIG. 8

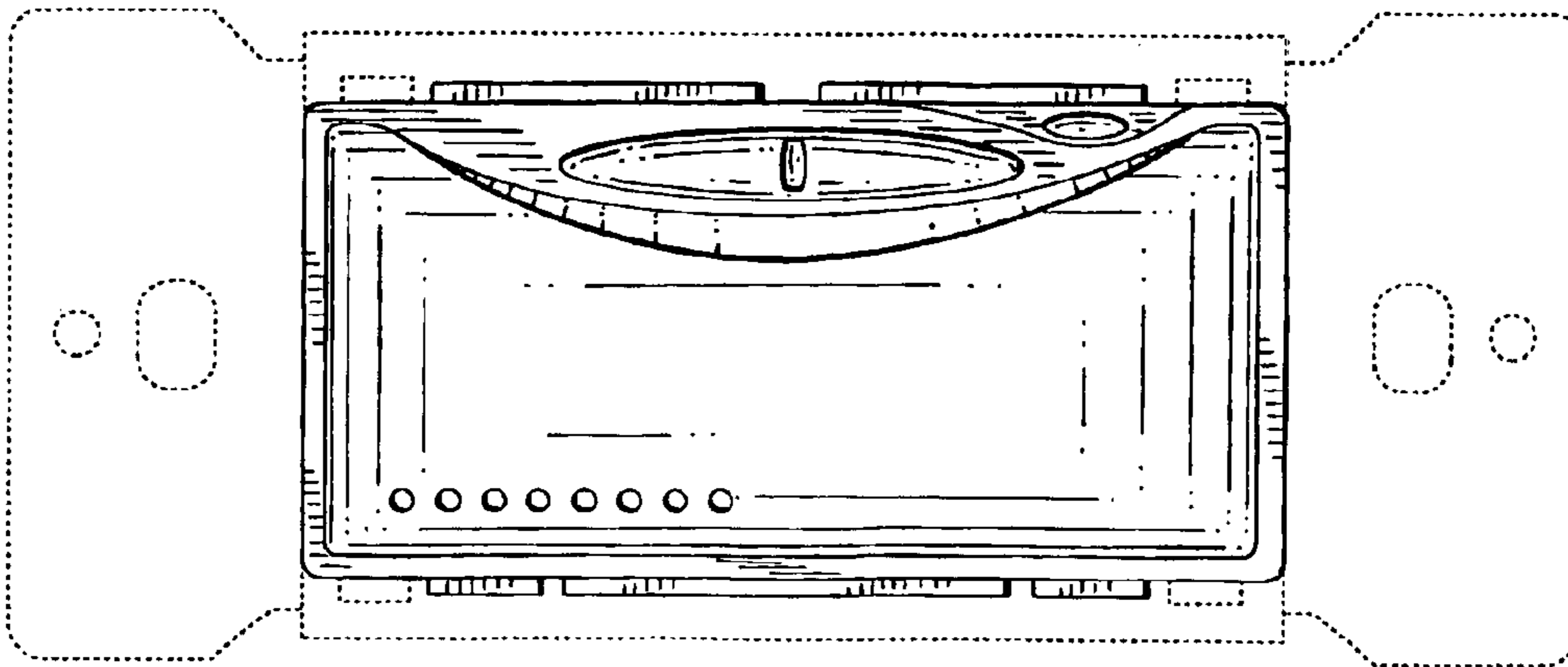

FIG. 7

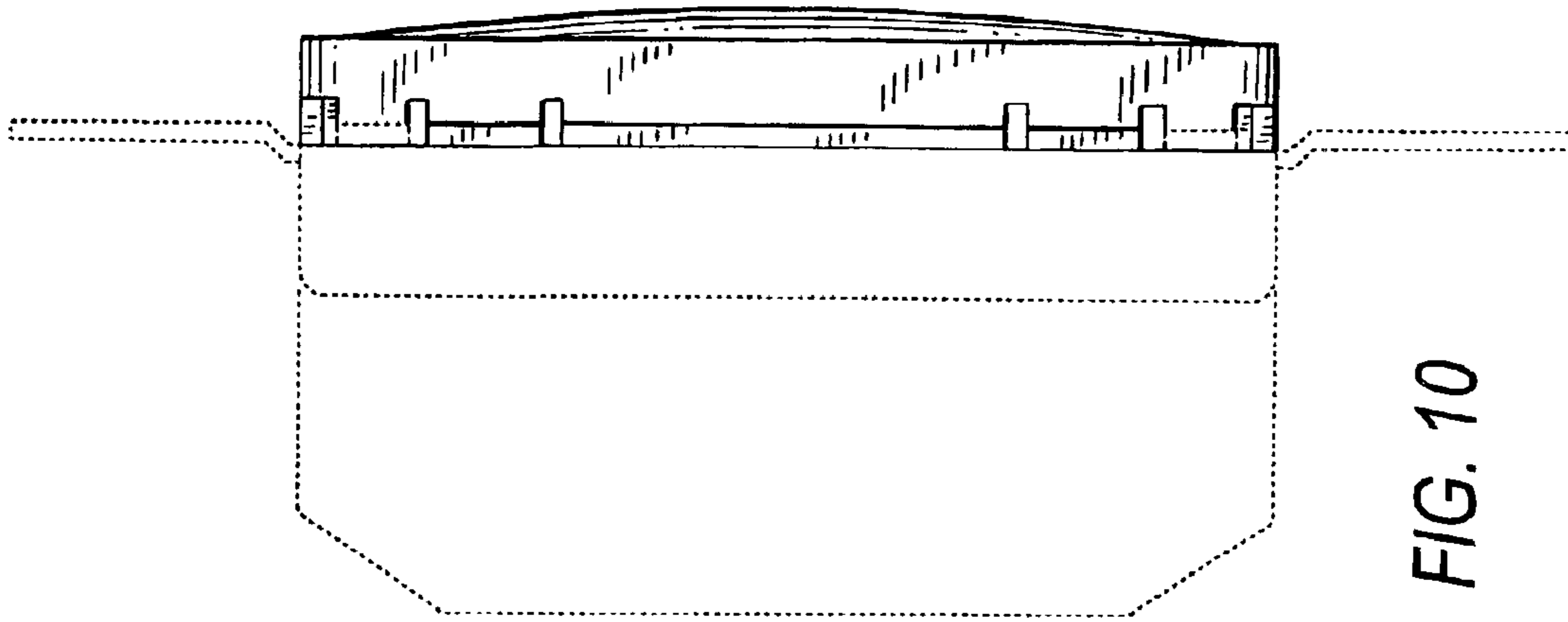

FIG. 10

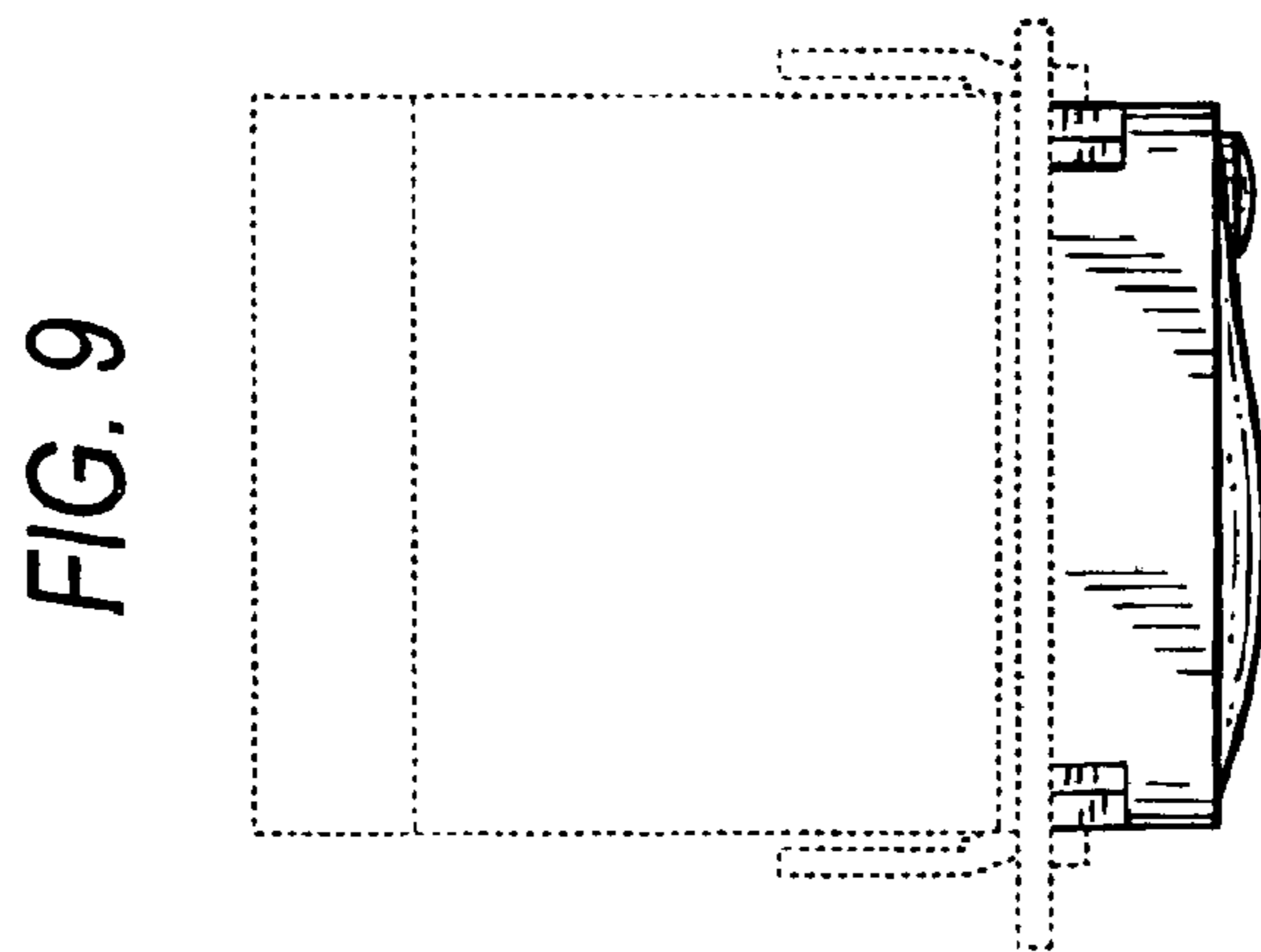

FIG. 9