

US00D503907S

(12) **United States Design Patent**  
**Beggio**

(10) **Patent No.:** **US D503,907 S**  
(45) **Date of Patent:** **\*\* Apr. 12, 2005**

(54) **MOTOSCOOTER**

(75) Inventor: **Ivano Beggio**, Venice (IT)

(73) Assignee: **Aprilia SpA**, Venice (IT)

(\*\*) Term: **14 Years**

(21) Appl. No.: **29/191,403**

(22) Filed: **Oct. 7, 2003**

(30) **Foreign Application Priority Data**

Jun. 19, 2003 (EM) ..... 42916

(51) **LOC (7) Cl.** ..... **12-11**

(52) **U.S. Cl.** ..... **D12/110**

(58) **Field of Search** ..... D12/110; 180/219,  
180/220, 225, 229

(56) **References Cited**

**U.S. PATENT DOCUMENTS**

- D399,174 S \* 10/1998 Takeshita et al. .... D12/110
- D427,944 S \* 7/2000 Sakuma et al. .... D12/110
- D443,232 S \* 6/2001 Chen ..... D12/110

\* cited by examiner

*Primary Examiner*—Alan P. Douglas

*Assistant Examiner*—Linda Brooks

(74) *Attorney, Agent, or Firm*—Katten Muchin Zavis  
Rosenman

(57) **CLAIM**

The ornamental design for a motoscooter, as shown and described.

**DESCRIPTION**

FIG. 1 is a front perspective view of a motoscooter showing my new design, as viewed from the right side;

FIG. 2 is a rear perspective view thereof as viewed from the right side;

FIG. 3 is a front view thereof;

FIG. 4 is a rear view thereof;

FIG. 5 is a left side elevation view thereof;

FIG. 6 is a right side elevation view thereof; and,

FIG. 7 is a top view thereof.

The bottom view of the motoscooter is not shown in the drawings and its ornamental design is not part of the claimed design.

**1 Claim, 7 Drawing Sheets**

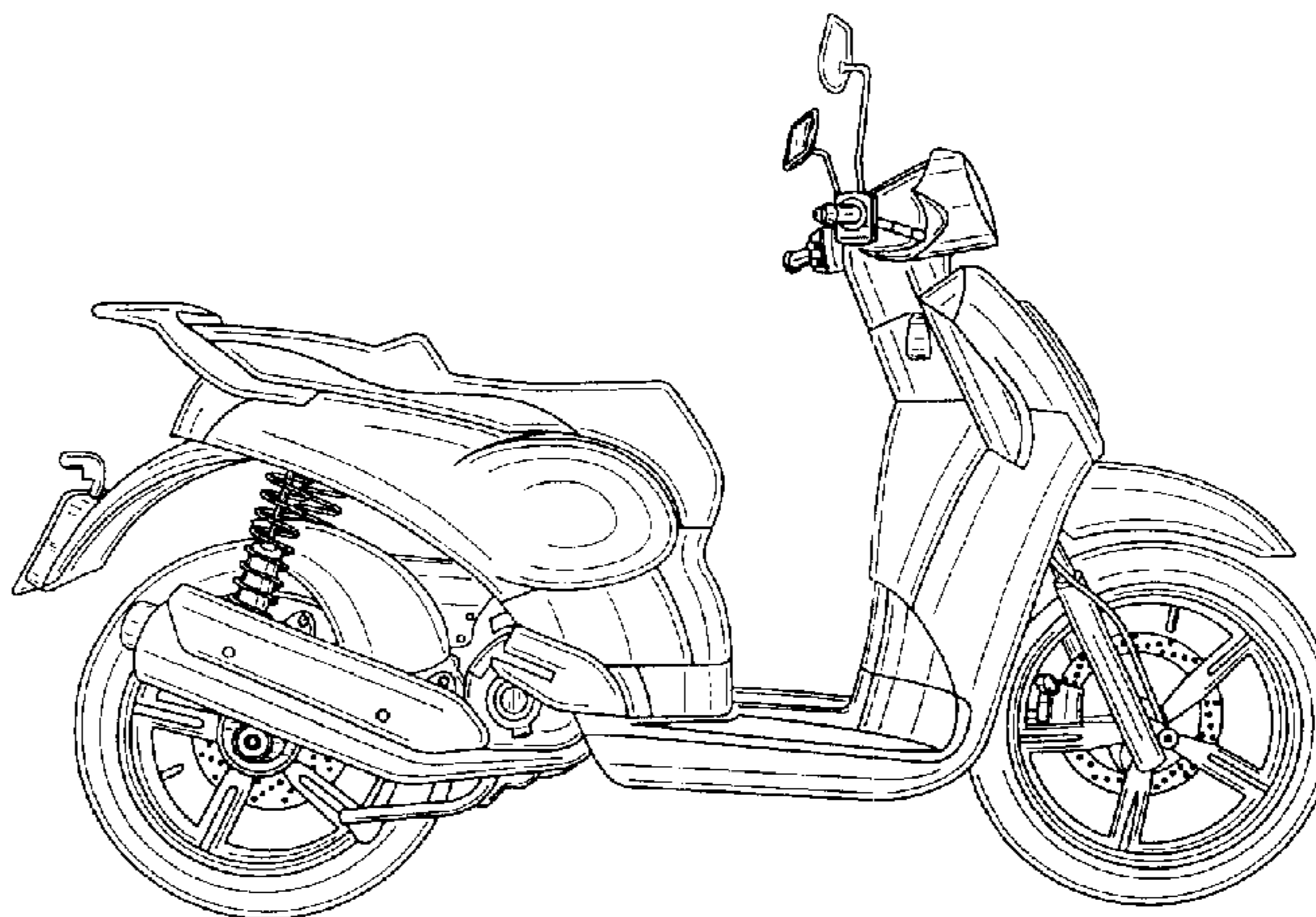
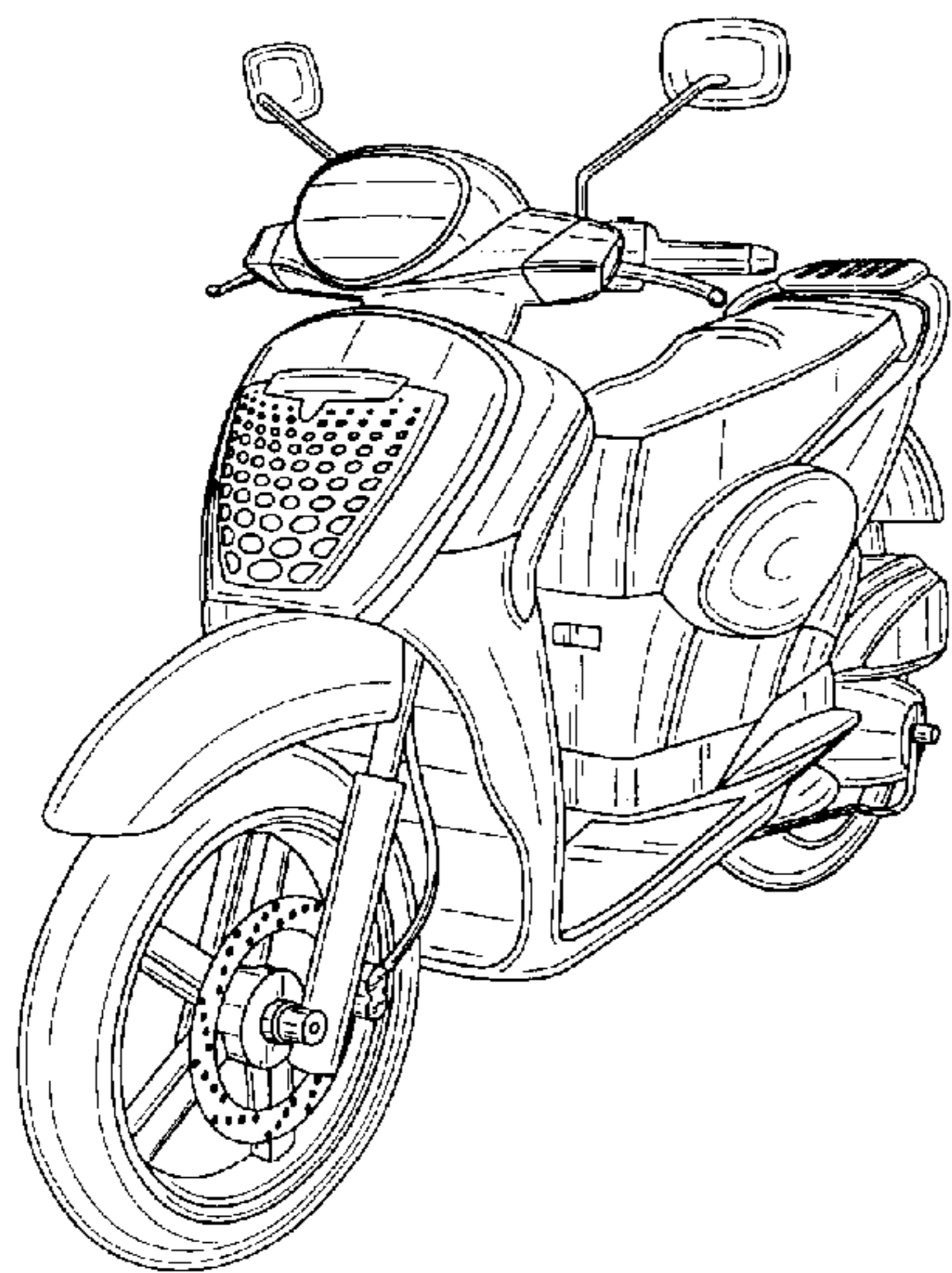

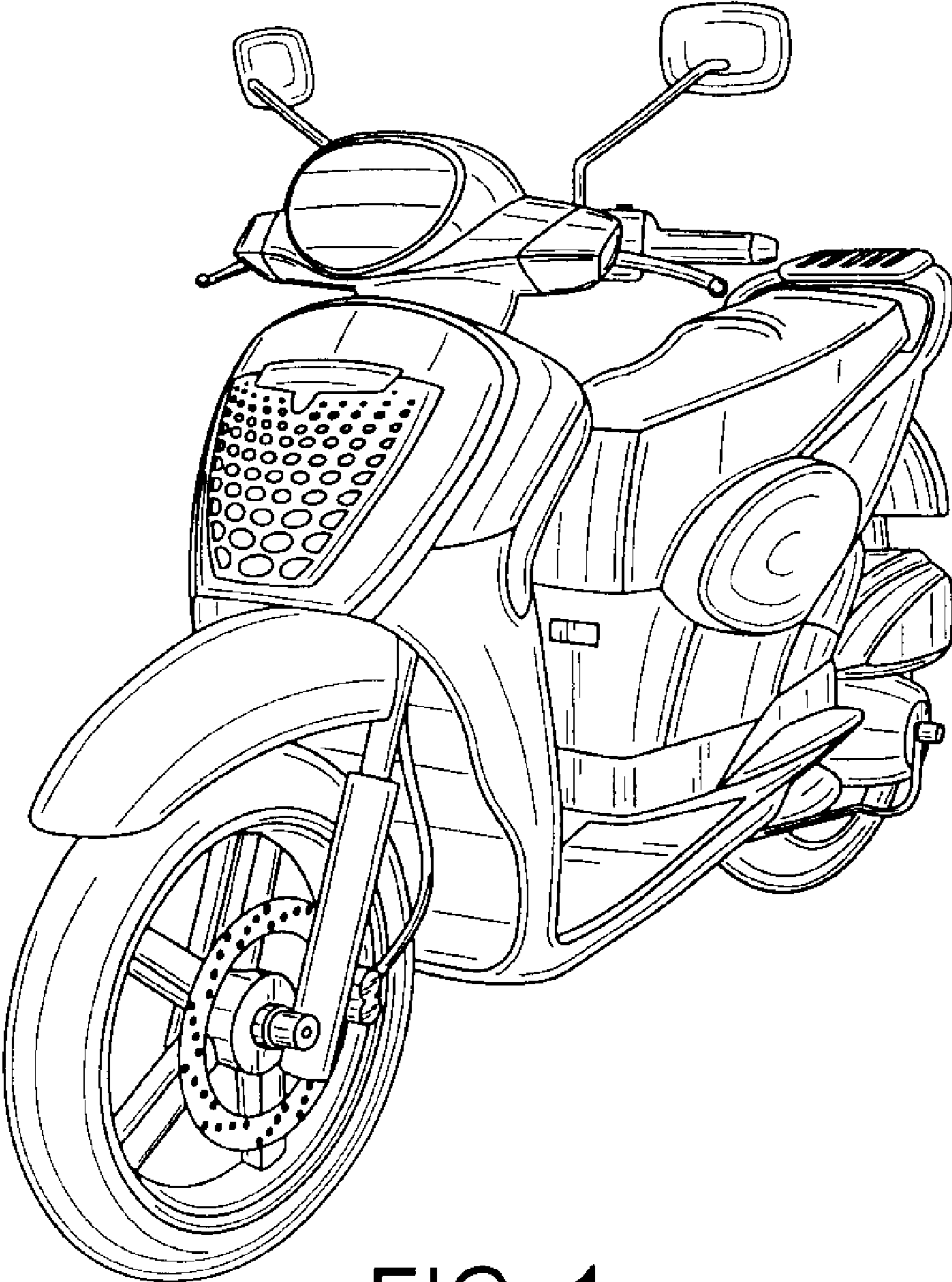

FIG. 1

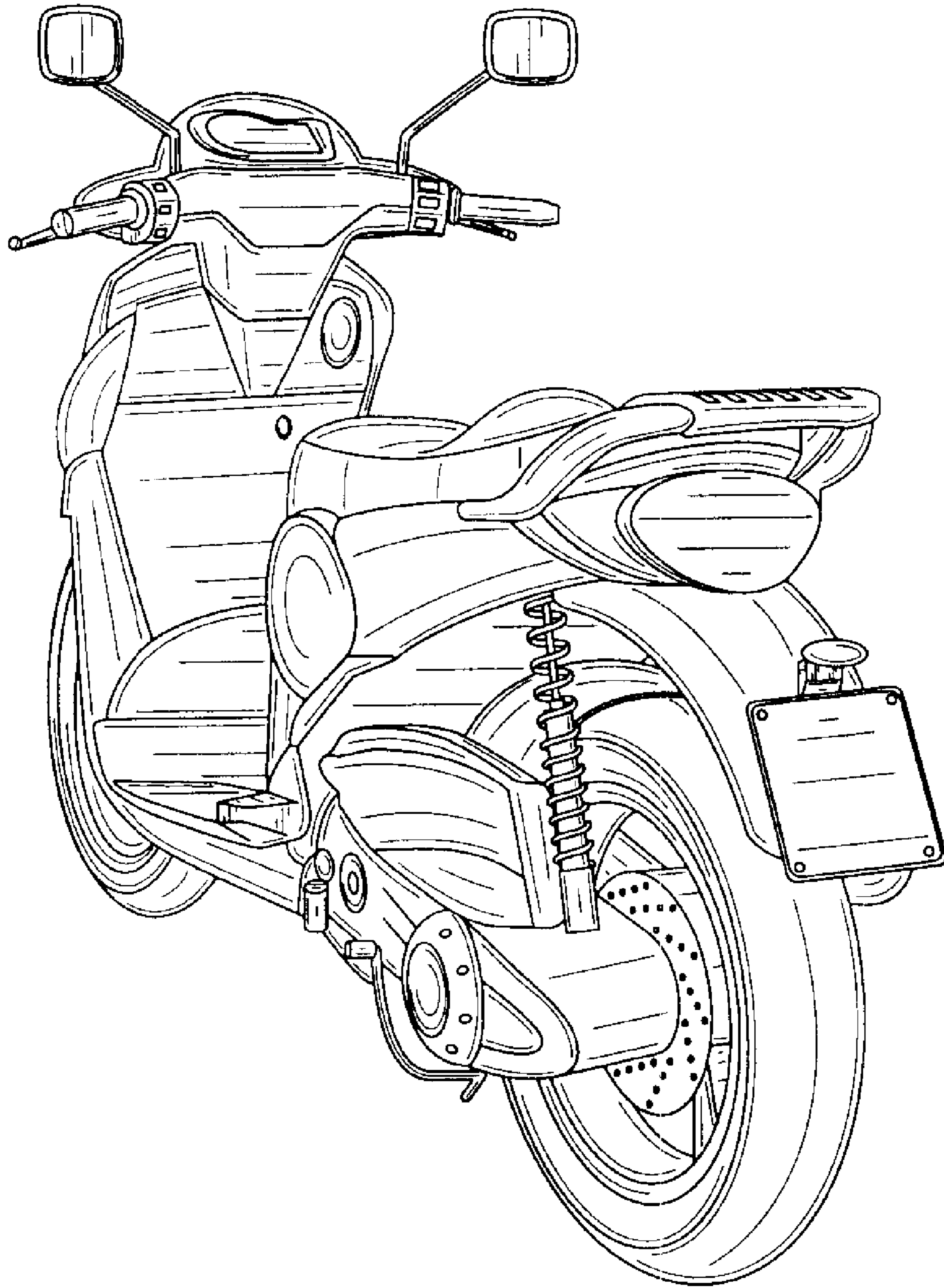

FIG. 2

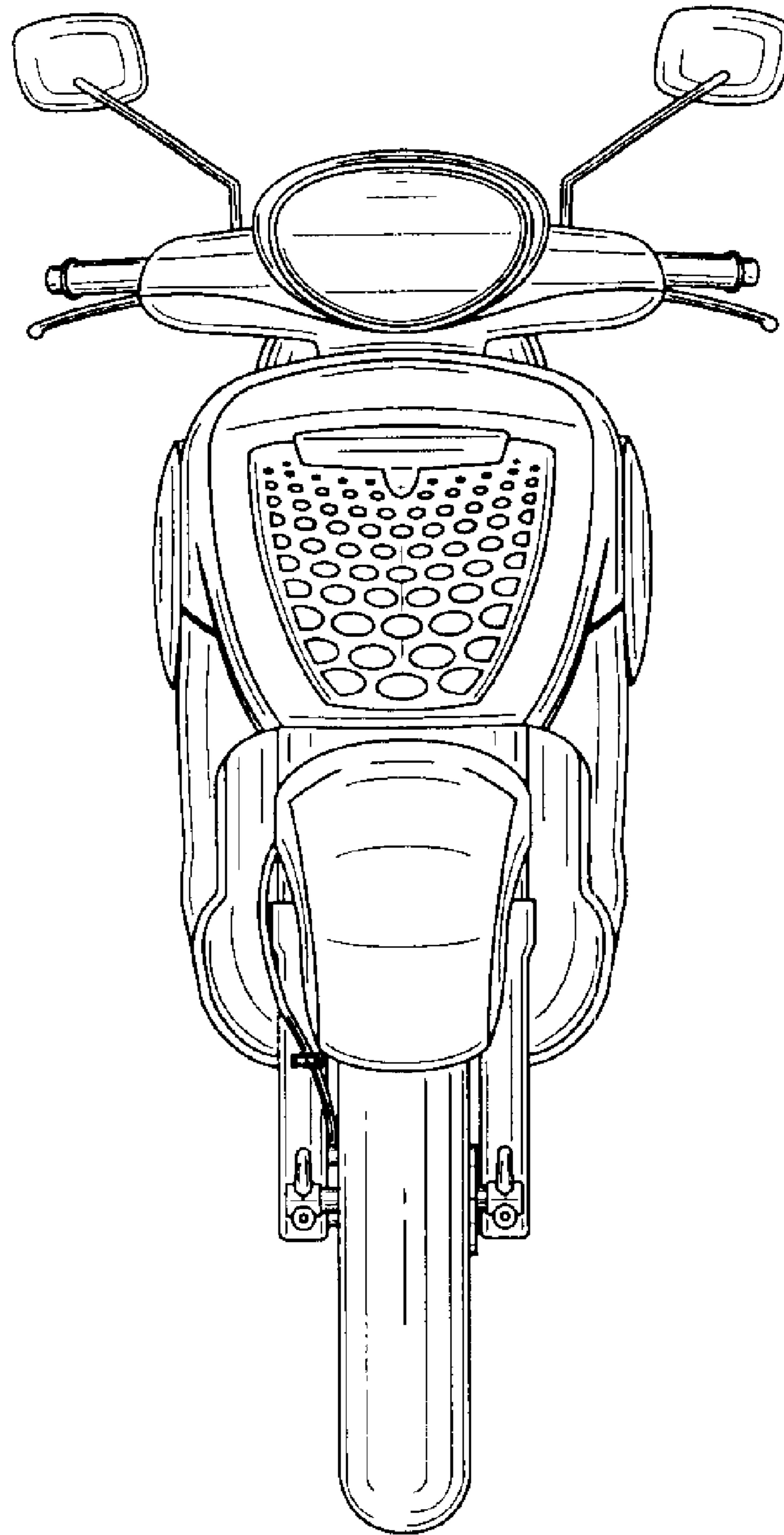

FIG. 3

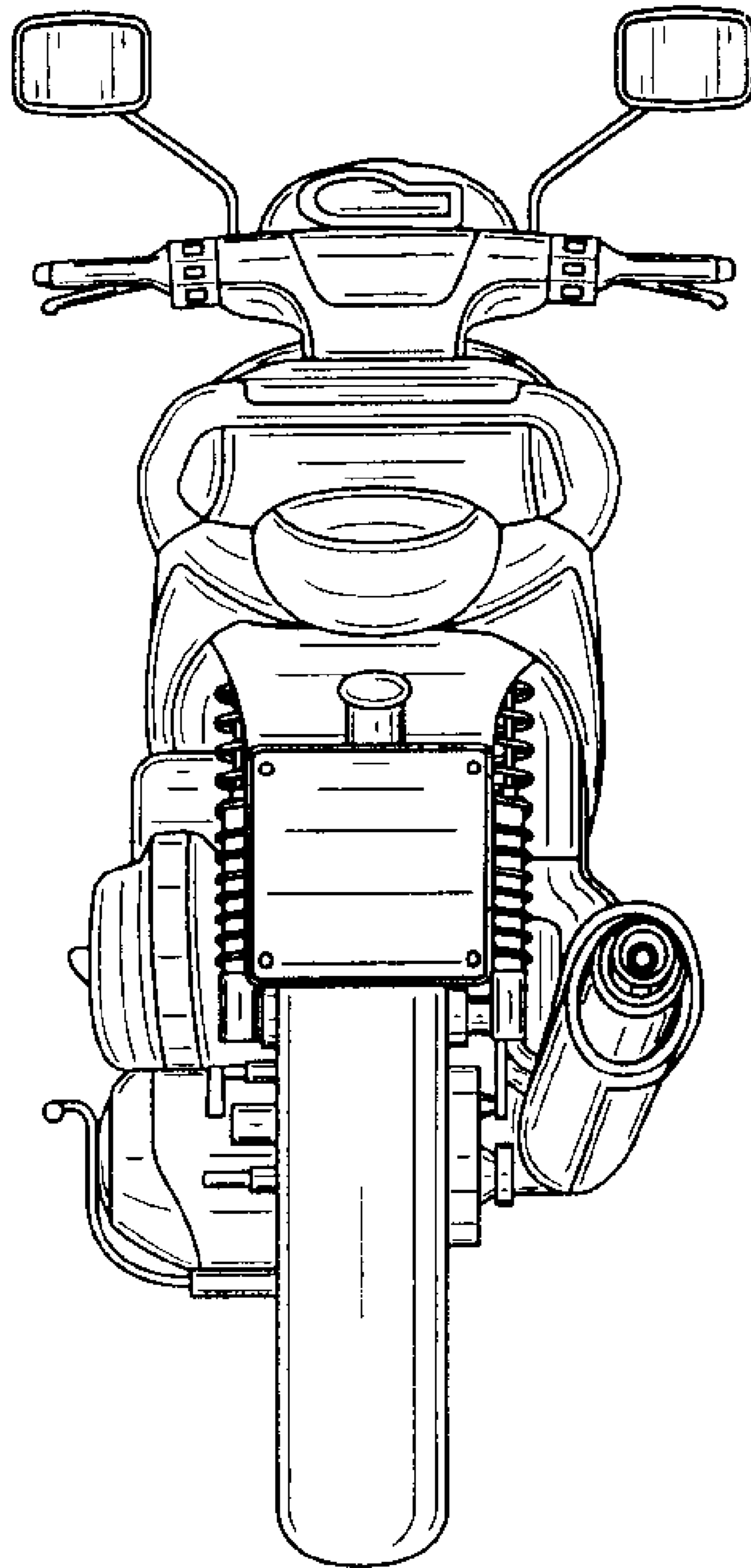

FIG. 4

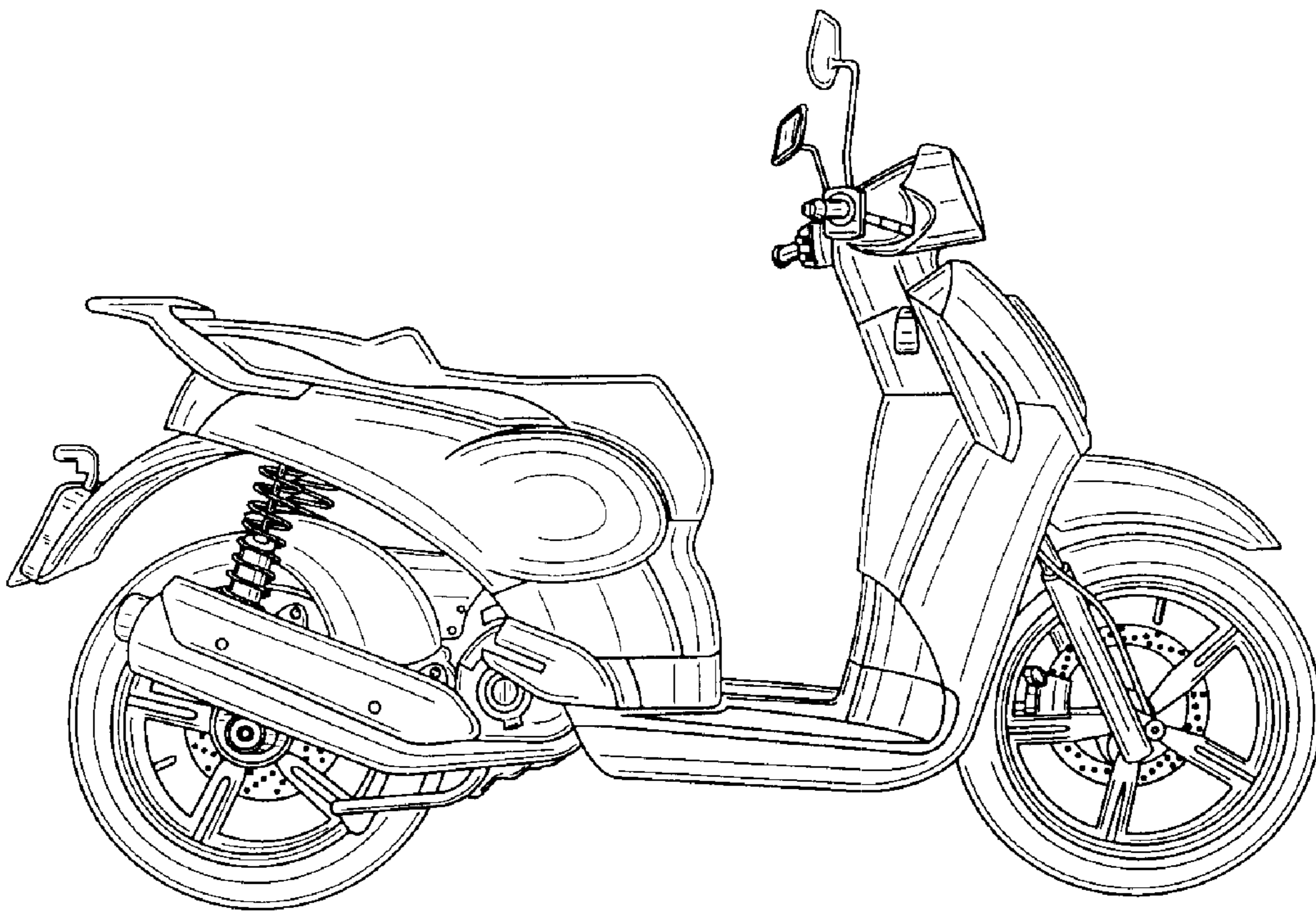

FIG. 5

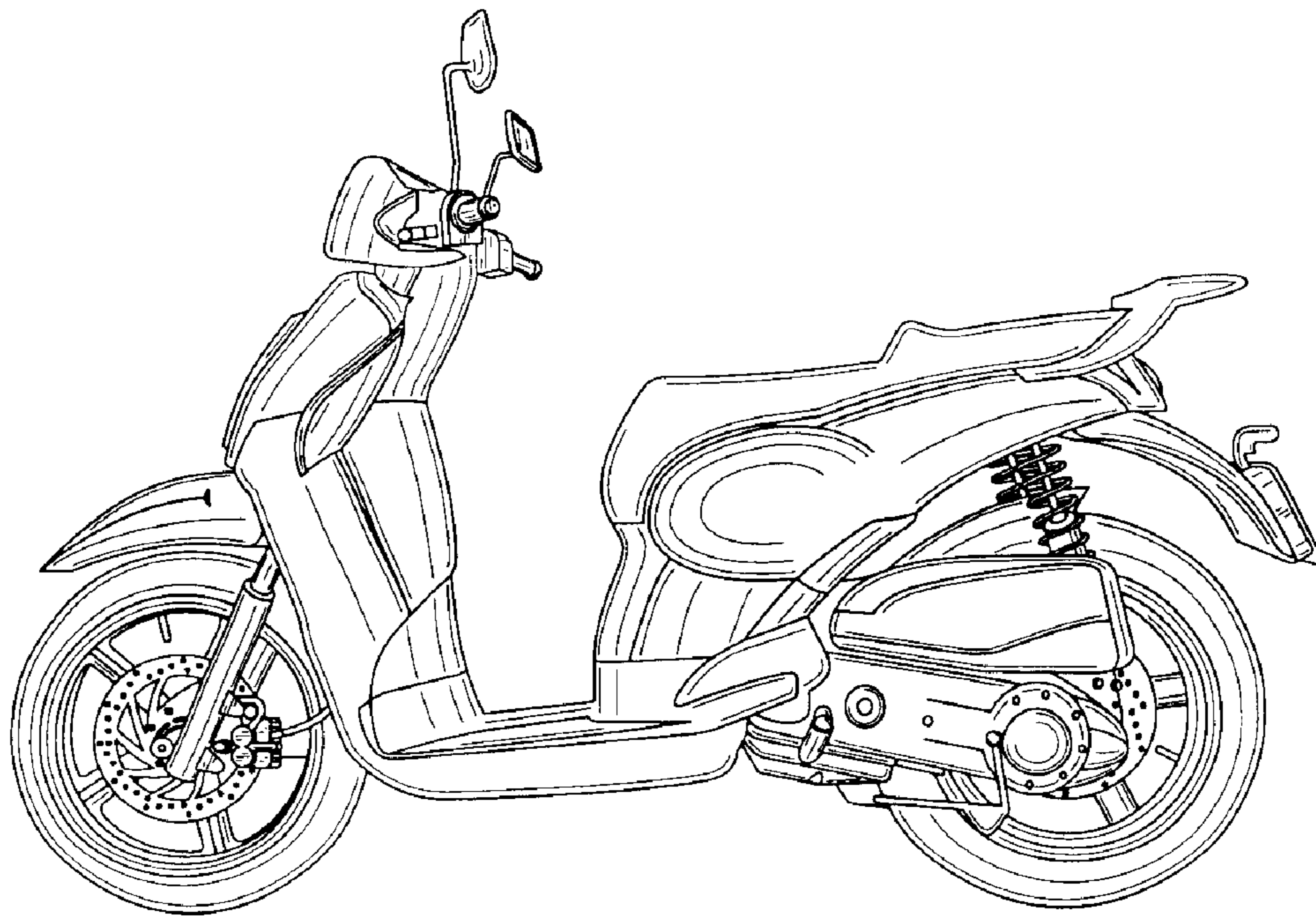

FIG. 6

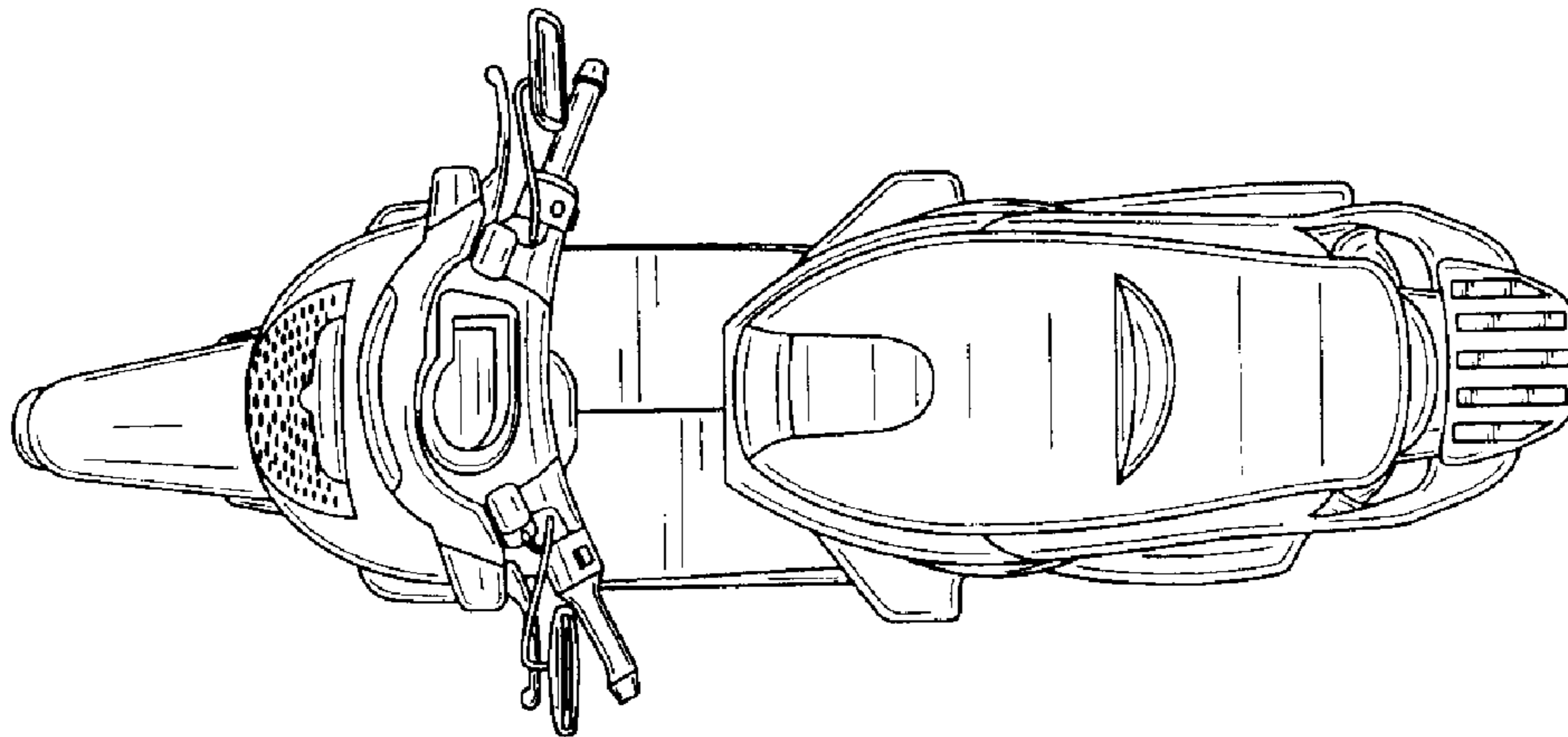

FIG. 7