

US00D503873S

(12) **United States Design Patent**
Bodum

(10) **Patent No.:** **US D503,873 S**
(45) **Date of Patent:** **** Apr. 12, 2005**

(54) **KNIFE**

D483,625 S * 12/2003 Chien D7/649

(75) **Inventor:** **Jørgen Bodum**, St. Niklausen (CH)

* cited by examiner

(73) **Assignee:** **PI-Design AG**, Triengen (CH)

Primary Examiner—Caron D. Veynar

(**) **Term:** **14 Years**

(74) *Attorney, Agent, or Firm*—Nath & Associates PLLC

(21) **Appl. No.:** **29/189,025**

(57) **CLAIM**

(22) **Filed:** **Aug. 28, 2003**

The ornamental design for a knife, as shown and described.

(30) **Foreign Application Priority Data**

DESCRIPTION

Mar. 3, 2003 (DK) DA 2003 00161

(51) **LOC (7) Cl.** **07-03**

(52) **U.S. Cl.** **D7/649; D7/401.2**

(58) **Field of Search** D7/642-652, 401.2;
D8/98, 99, 107; D22/117, 118; 16/110.1,
430, 431; 30/147-150, 155-163, 329, 340,
342-345

FIG. 1 is an oblique perspective view of the knife;

FIG. 2 is a front view of the knife, as shown in FIG. 1;

FIG. 3 is a back side view of the knife;

FIG. 4 is a right side view of the knife;

FIG. 5 is a left side view of the knife;

FIG. 6 is a top view of the knife; and,

FIG. 7 is a bottom view of the knife.

(56) **References Cited**

U.S. PATENT DOCUMENTS

D462,582 S * 9/2002 Parlowski D7/649

1 Claim, 7 Drawing Sheets

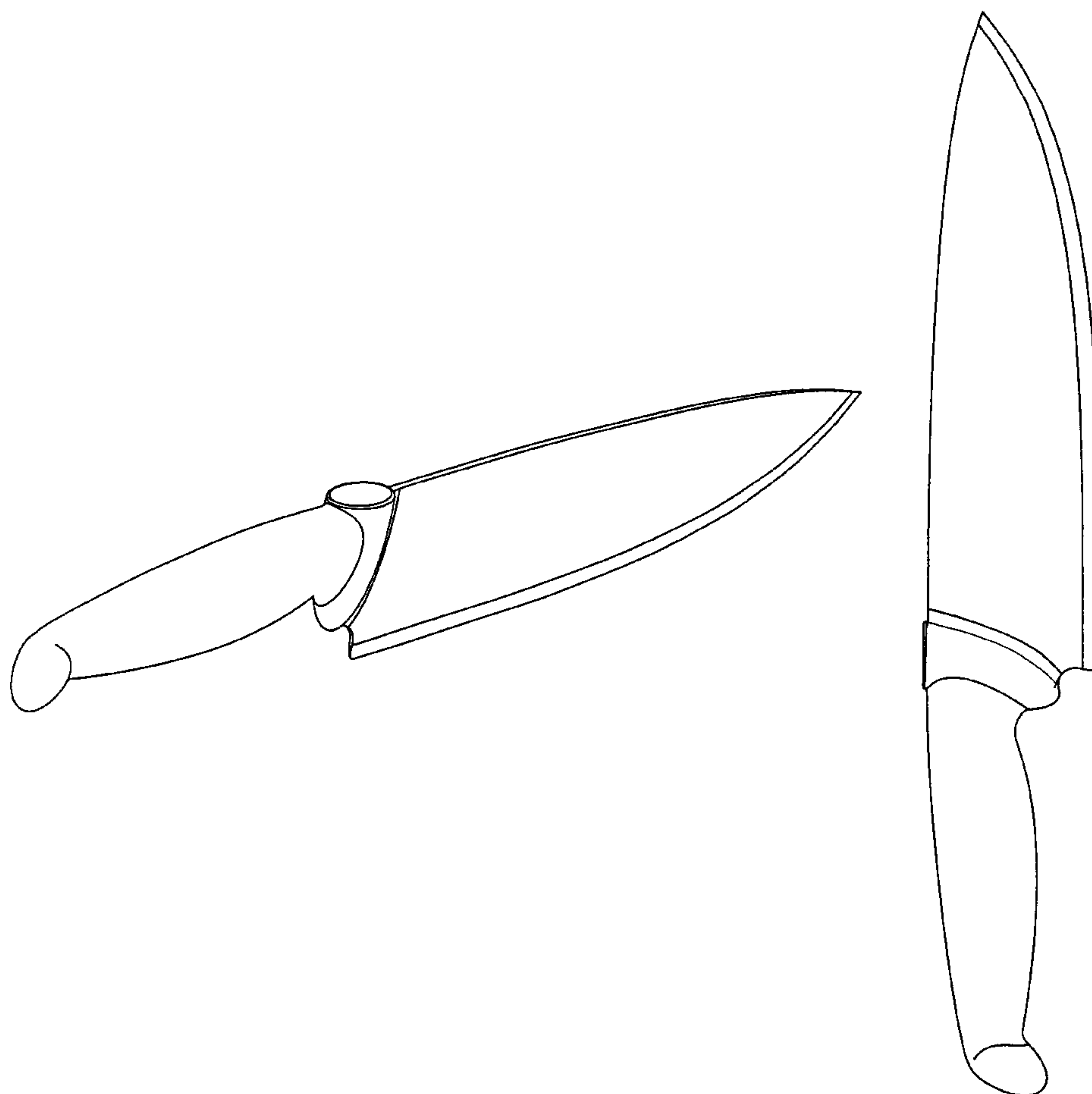

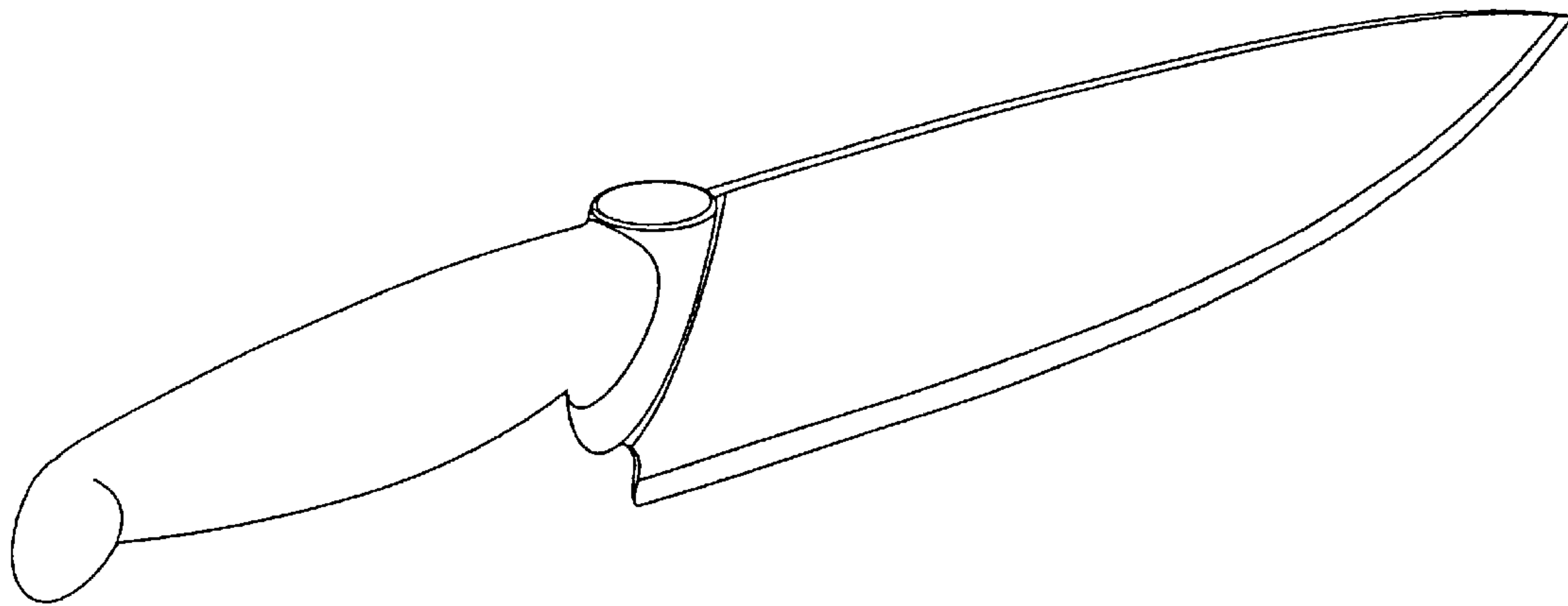

Fig. 1

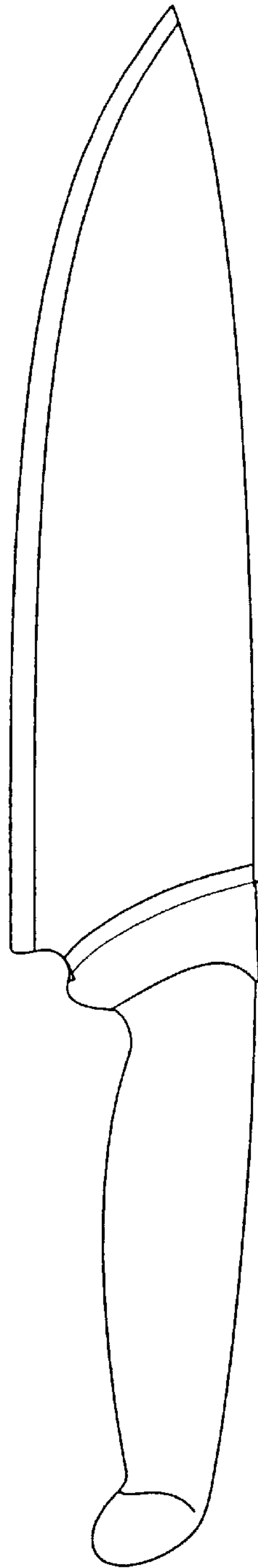

Fig. 2

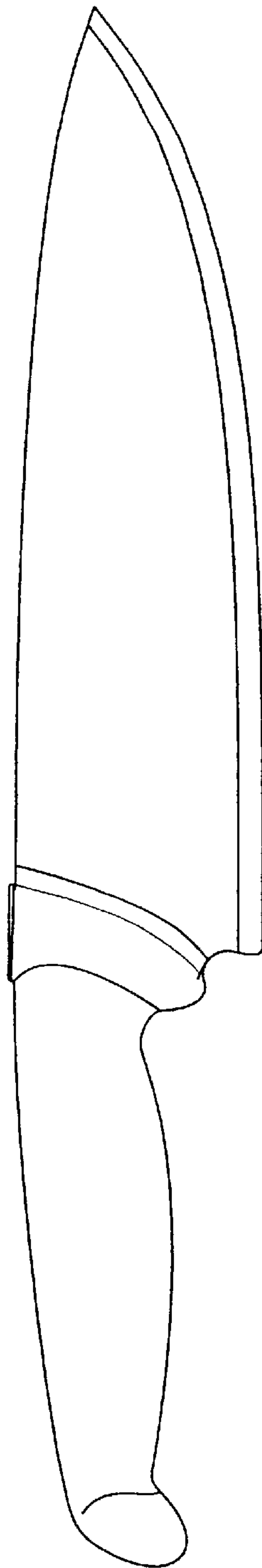

Fig. 3

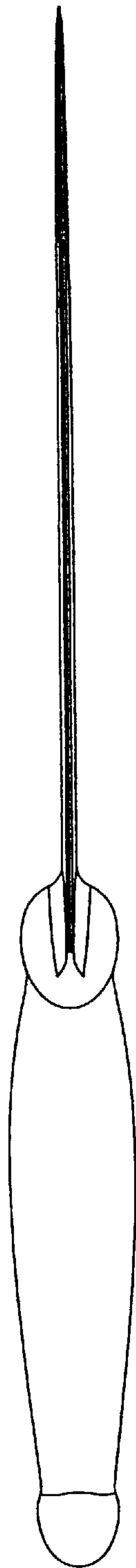

Fig. 4

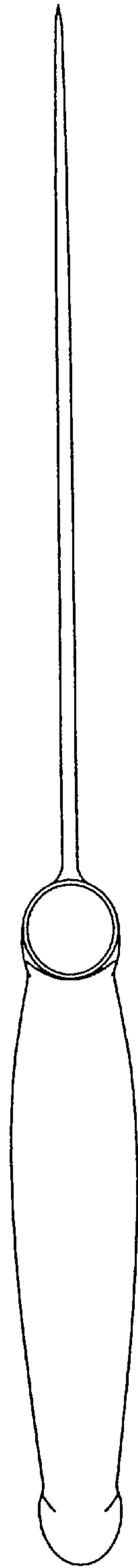

Fig. 5

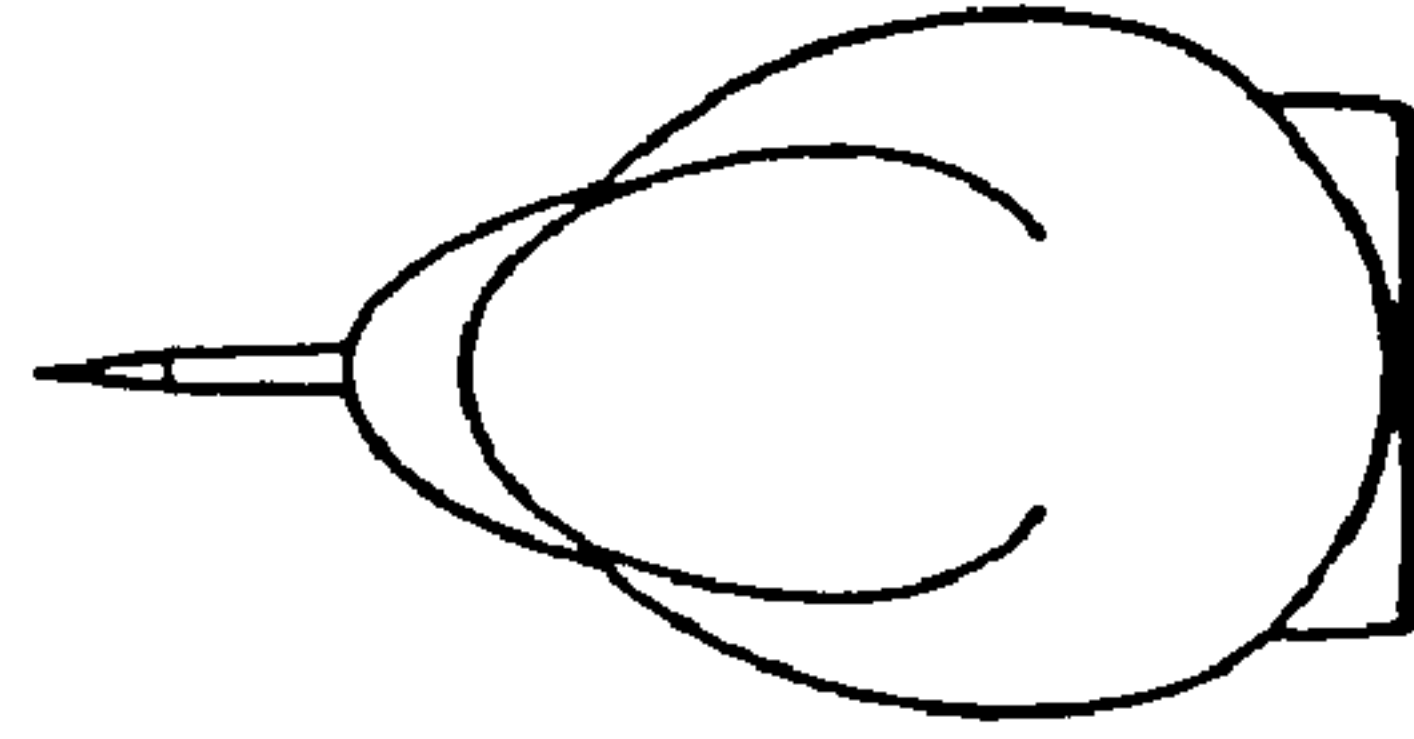

Fig. 6

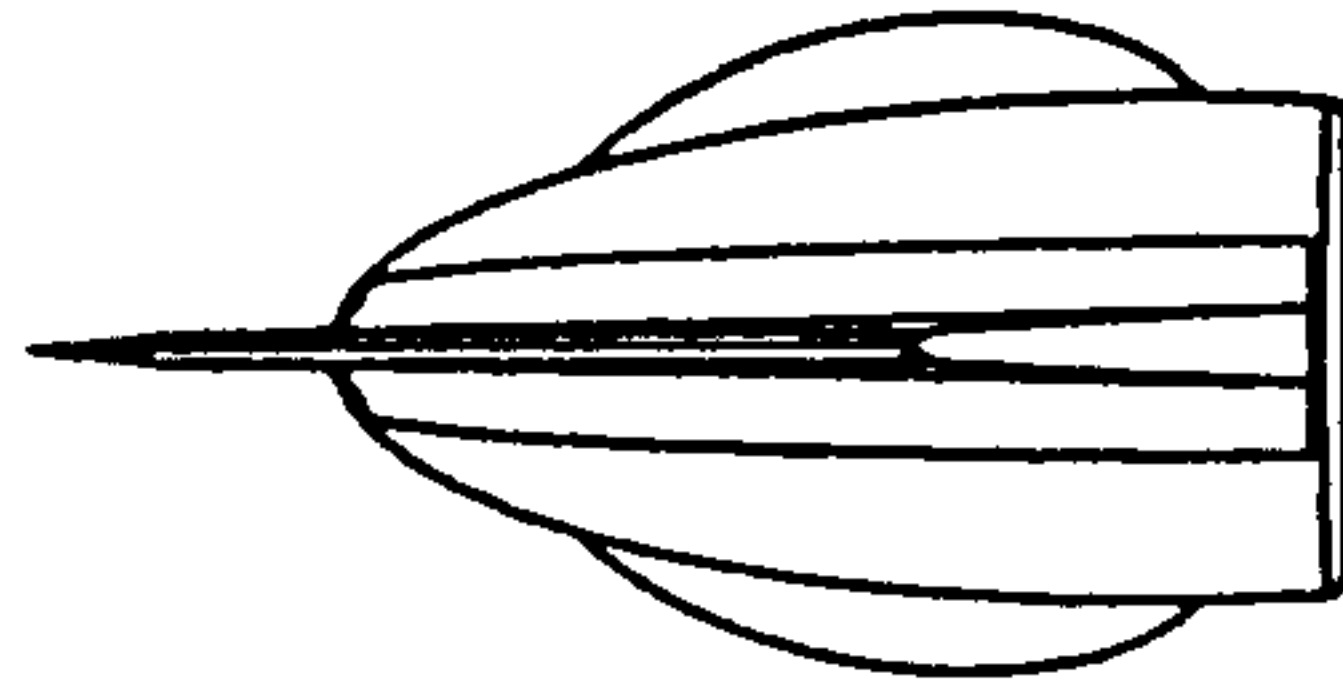

Fig. 7