



US00D503832S

(12) **United States Design Patent**
Kennon

(10) **Patent No.:** **US D503,832 S**

(45) **Date of Patent:** **** Apr. 5, 2005**

(54) **FIRE EXTINGUISHER HOUSING AND STAND**

(76) **Inventor:** **Add T. Kennon**, 6 Sandy Beach, Vallejo, CA (US) 94590

(**) **Term:** **14 Years**

(21) **Appl. No.:** **29/190,848**

(22) **Filed:** **Sep. 26, 2003**

(51) **LOC (7) Cl.** **29-01**

(52) **U.S. Cl.** **D29/130; D6/448**

(58) **Field of Search** D29/130, 125; D10/113, 109; D6/573, 559, 515, 421, 561, 509, 448, 432; 312/296, 248, 249.2, 245; 220/344; 169/51, 48

(56) **References Cited**

U.S. PATENT DOCUMENTS

3,175,873	A	*	3/1965	Blomquist	312/296
D232,223	S	*	7/1974	Bartley	D6/421
4,017,133	A	*	4/1977	Sigler	220/265
4,046,439	A	*	9/1977	Lee	312/139.2
D250,377	S	*	11/1978	Dooley et al.	D6/559
D252,121	S	*	6/1979	Rutherford	D6/573
4,246,451	A	*	1/1981	Nix	248/553
4,449,588	A	*	5/1984	Benlolo et al.	169/48
4,998,587	A	*	3/1991	Thomas	169/51
5,184,684	A	*	2/1993	Kohlman	169/51
5,195,595	A	*	3/1993	Nakagawa	169/51
D390,490	S	*	2/1998	Ruderick	D10/109
5,722,557	A	*	3/1998	Smith	220/476
D412,131	S	*	7/1999	Bent et al.	D10/113

5,975,475	A	*	11/1999	Chaplin	248/311.2
D427,467	S	*	7/2000	Akoto	D6/515
D458,485	S	*	6/2002	Tramontina	D6/515
D459,035	S	*	6/2002	Baskinger et al.	D29/125
D462,286	S	*	9/2002	Perelli	D10/113
D463,183	S	*	9/2002	Tramontina	D6/515

* cited by examiner

Primary Examiner—Jeffrey Asch

Assistant Examiner—Austin Murphy

(74) *Attorney, Agent, or Firm*—Goldstein Law Offices, P.C.

(57) **CLAIM**

The ornamental design for a fire extinguisher housing and stand, as shown and described.

DESCRIPTION

FIG. 1 is a perspective view of a fire extinguisher housing and stand.

FIG. 2 is a front elevational view thereof.

FIG. 3 is a rear elevational view thereof.

FIG. 4 is a right side elevational view thereof.

FIG. 5 is a left side elevational view thereof.

FIG. 6 is a top plan view of the fire extinguisher housing and stand.

FIG. 7 is a bottom plan view thereof; and,

FIG. 8 is a perspective view of the housing and stand, illustrating the housing in an open position having a fire extinguisher stored therein, the extinguisher shown in broken lines representing environmental association matter being for illustrative purposes only and forming no part of the claimed invention.

1 Claim, 5 Drawing Sheets

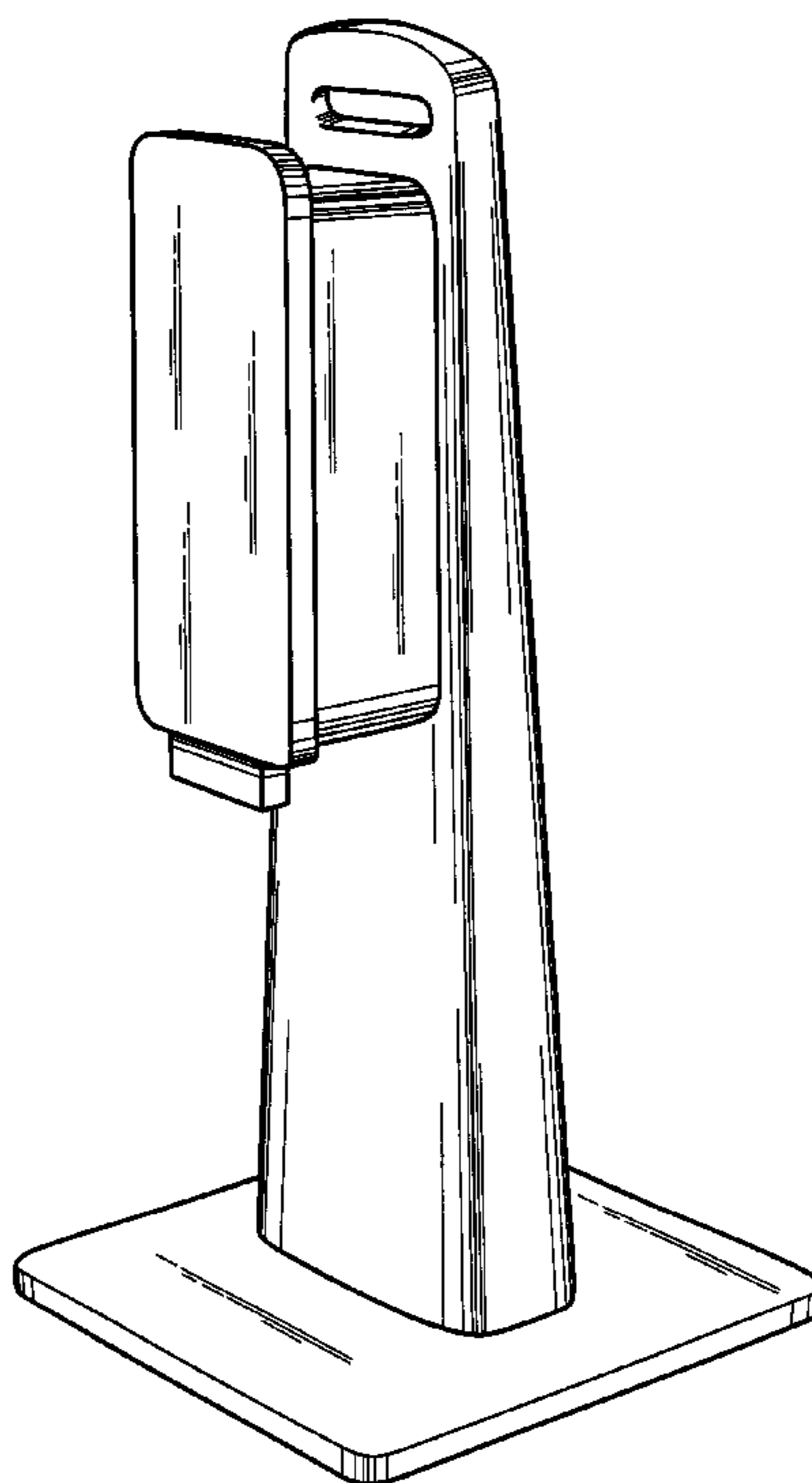

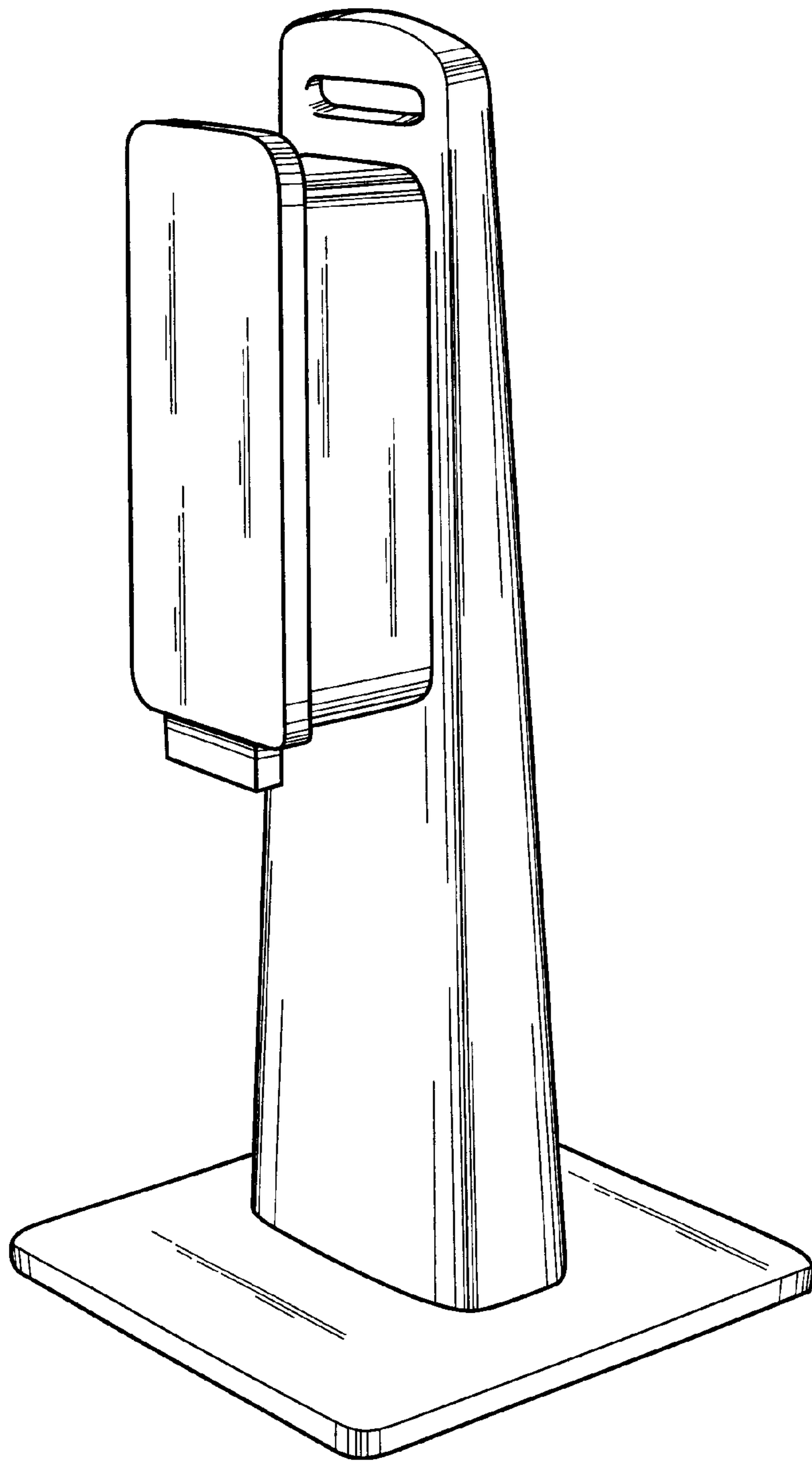

FIG. 1

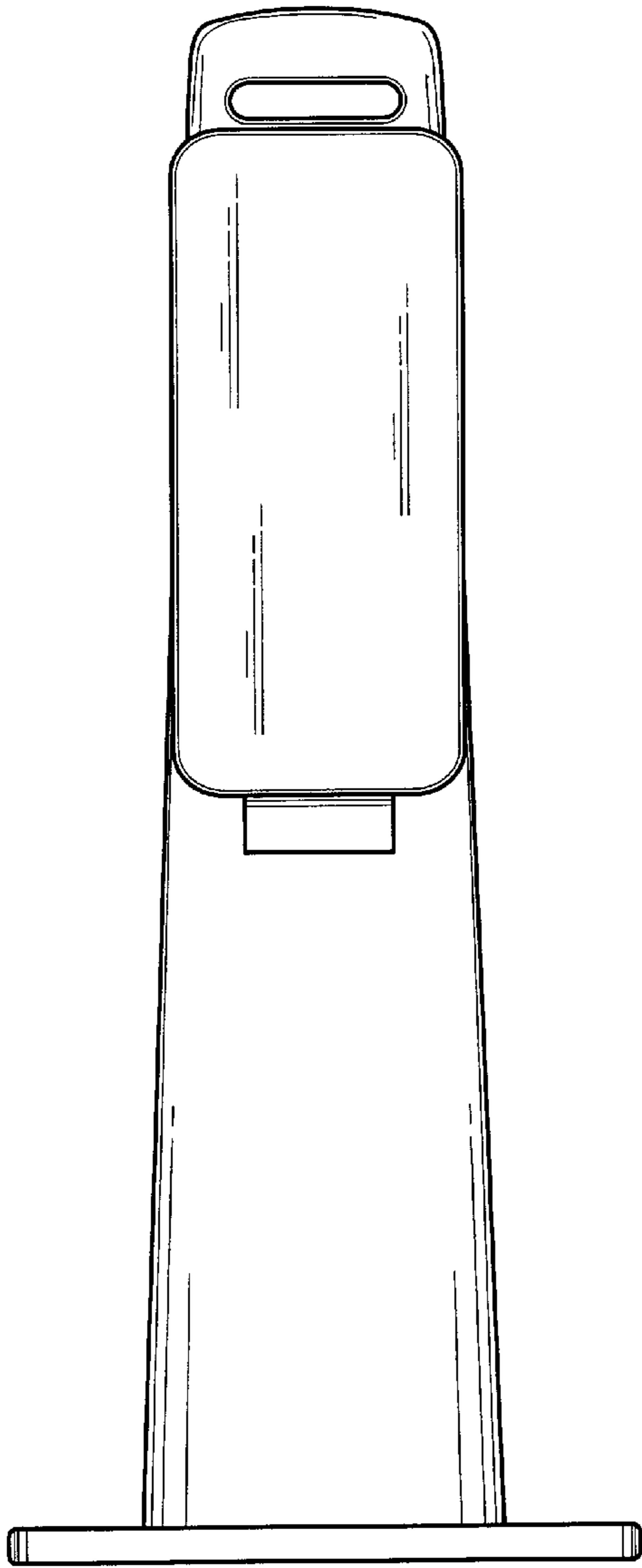

FIG. 2

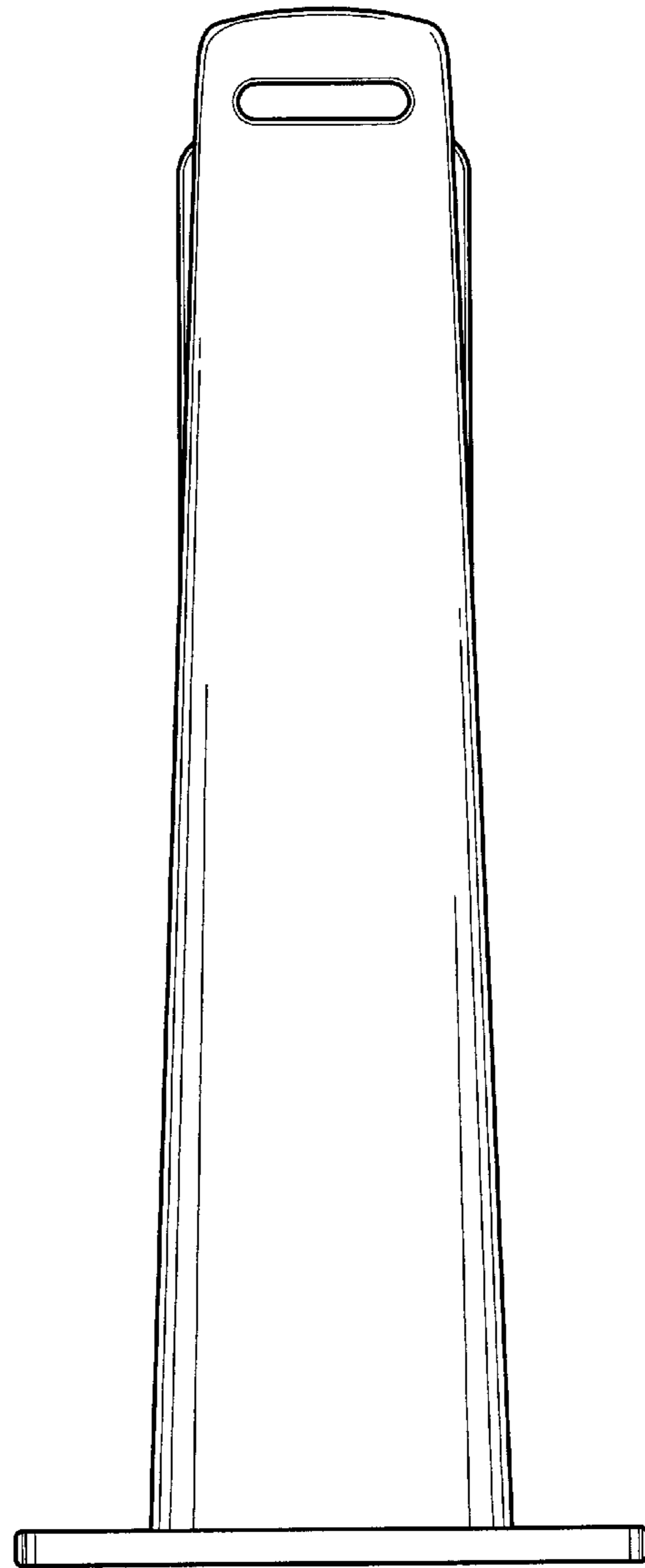

FIG. 3

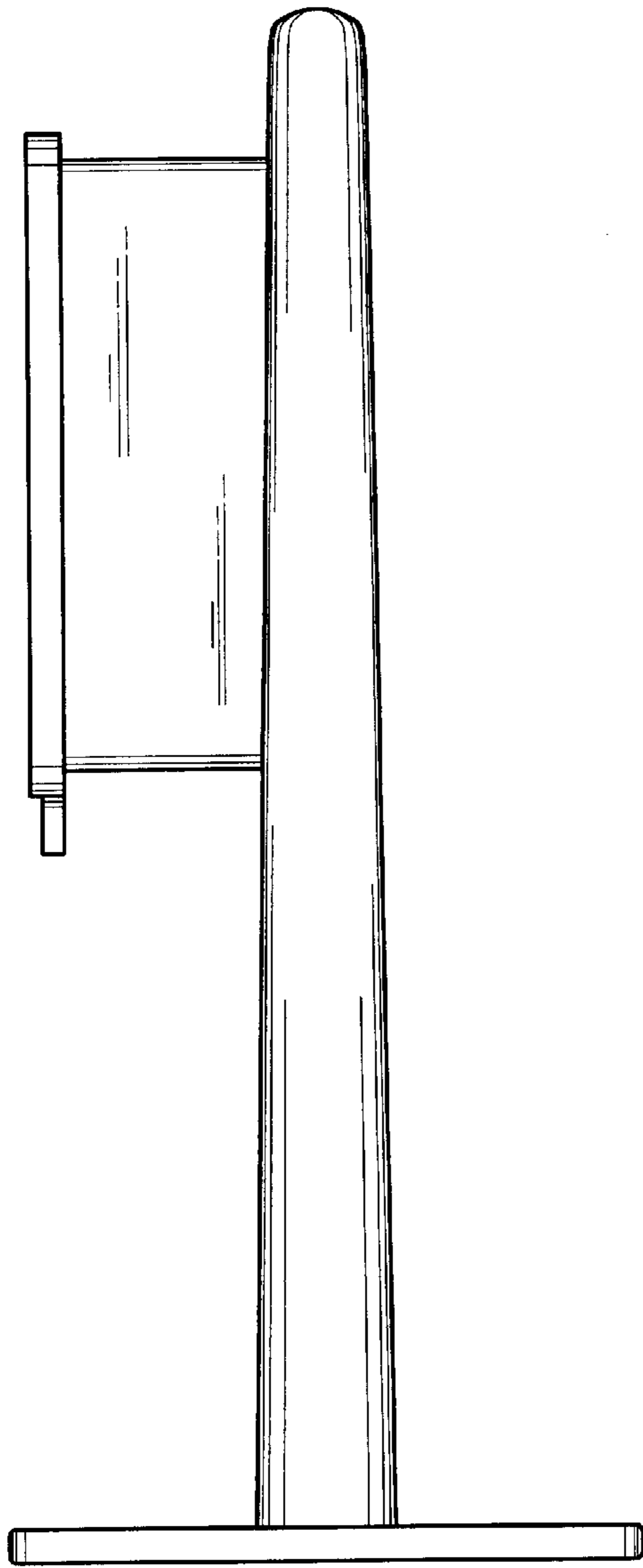

FIG. 4

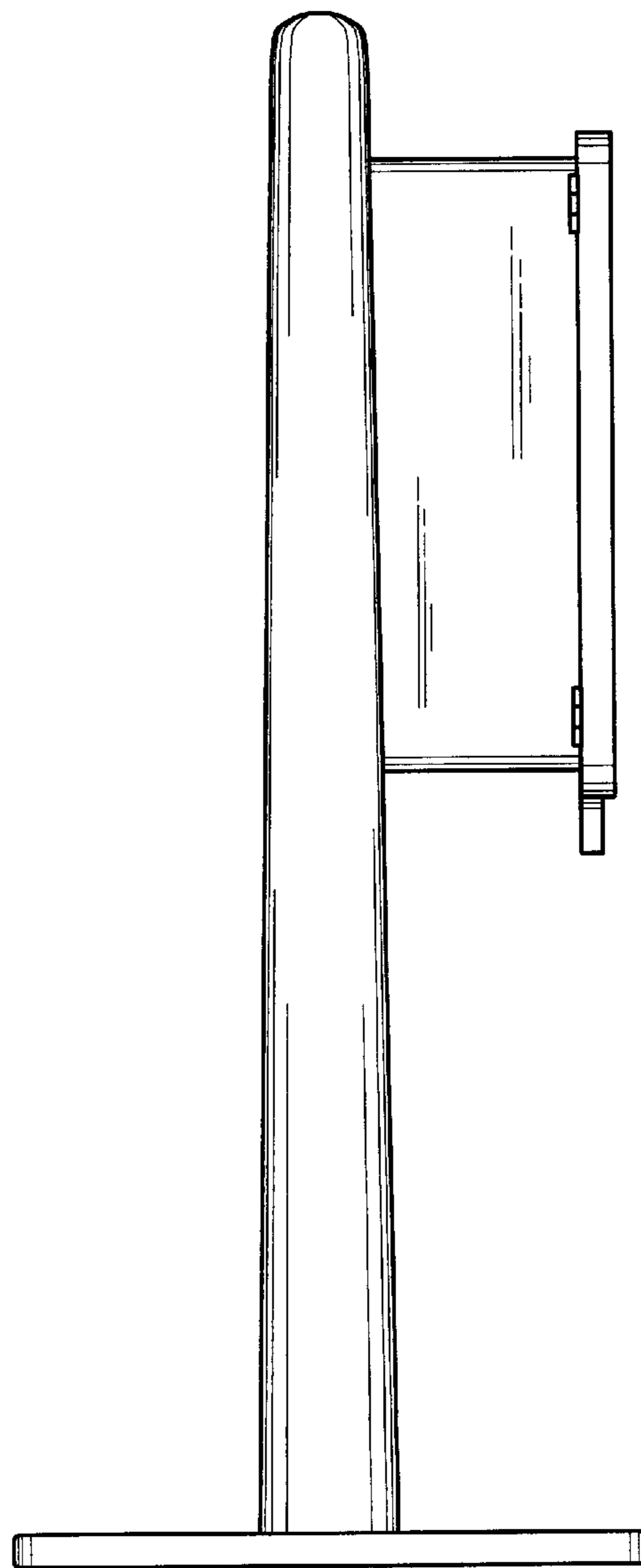

FIG. 5

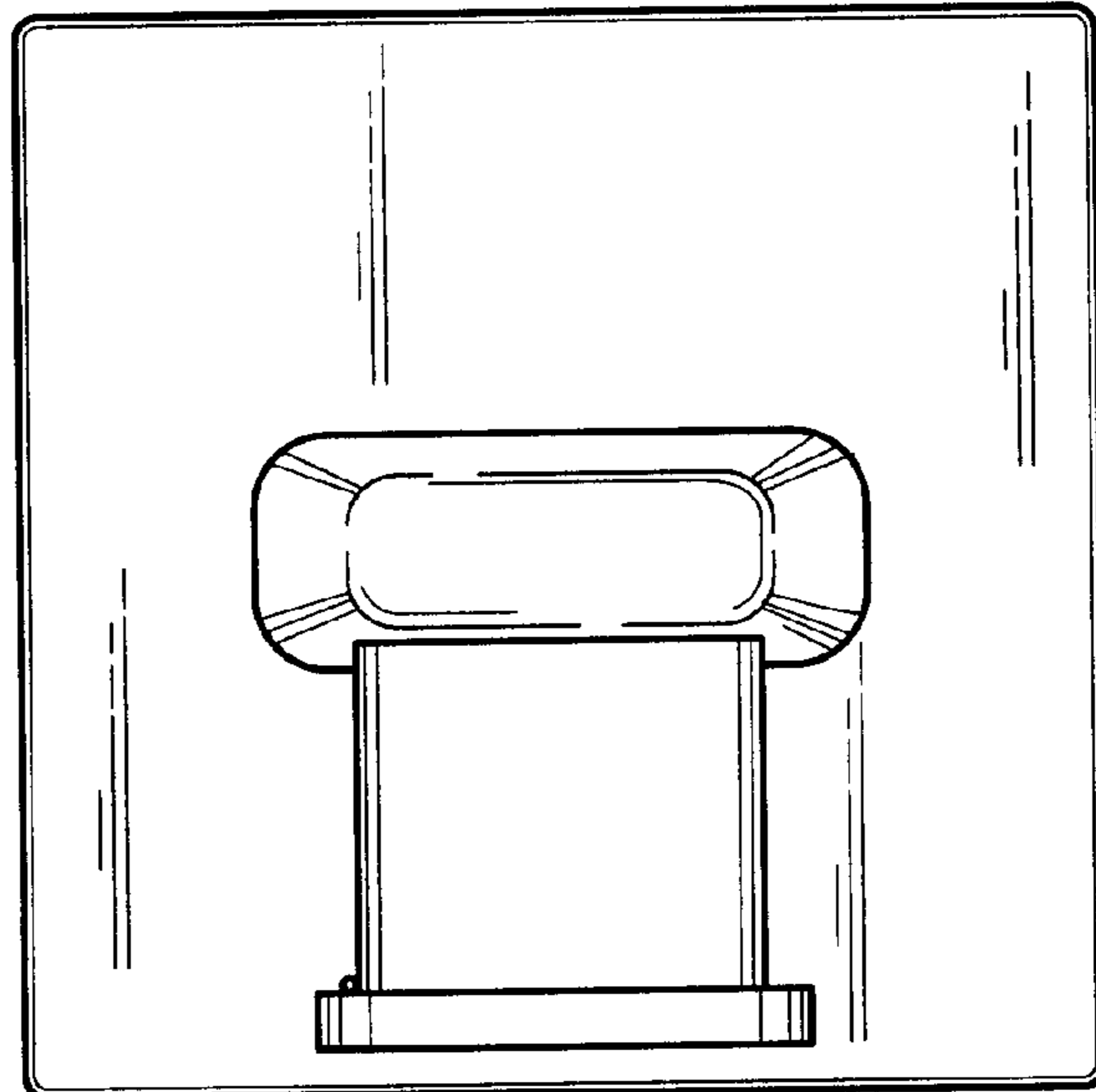

FIG. 6

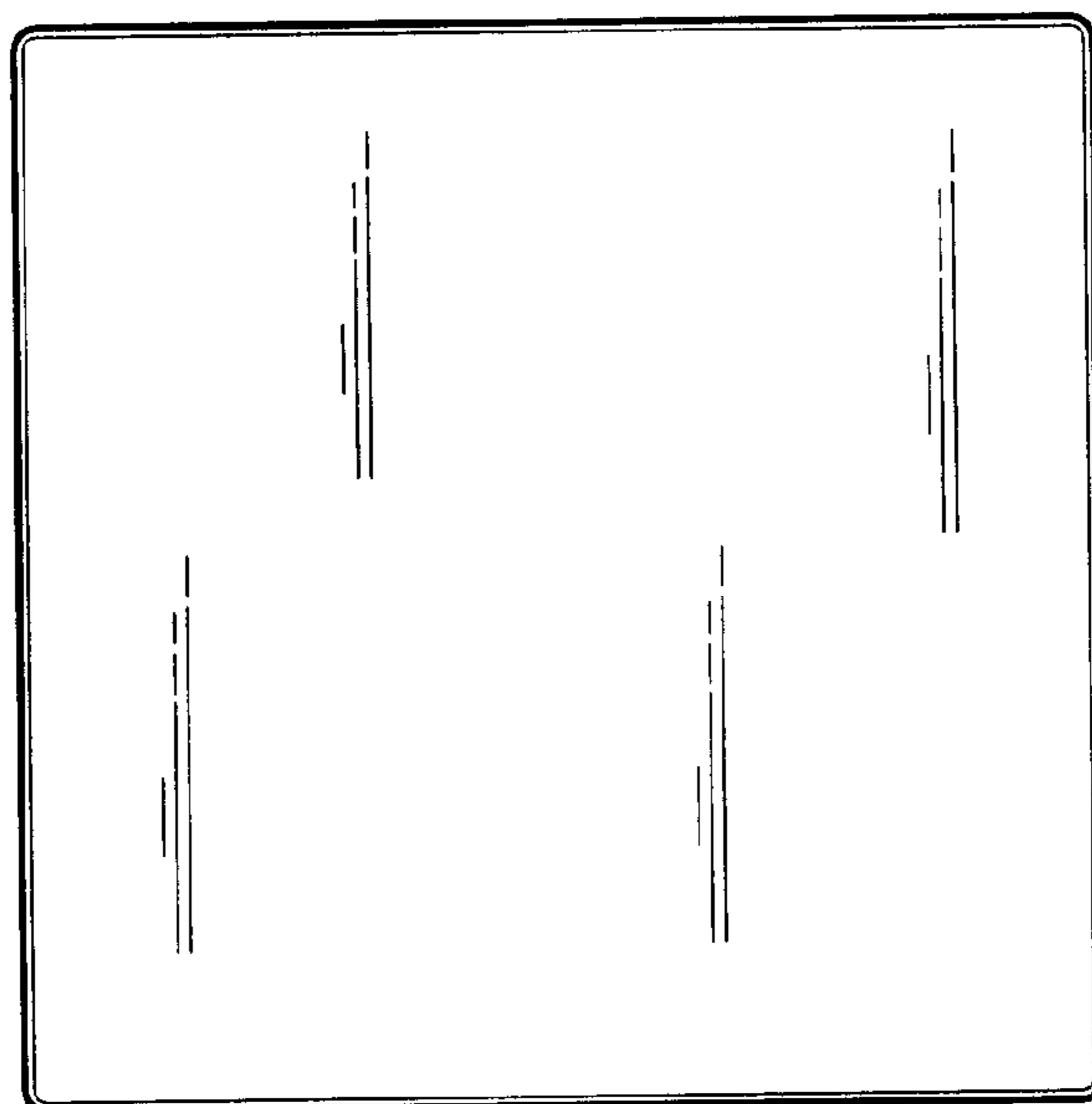

FIG. 7

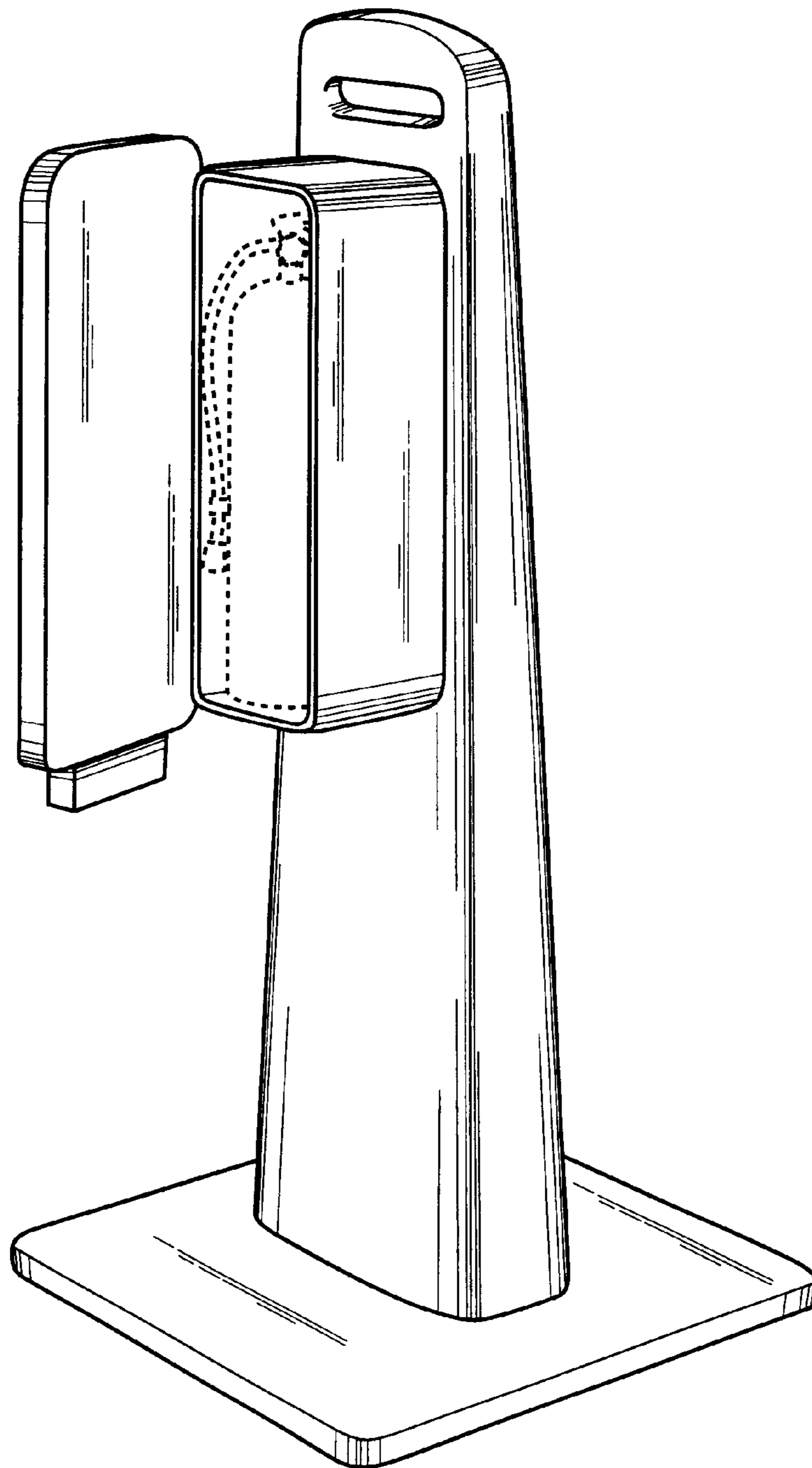

FIG. 8