

US00D503829S

(12) **United States Design Patent**
Tanii et al.

(10) **Patent No.:** **US D503,829 S**
(45) **Date of Patent:** **** Apr. 5, 2005**

(54) **COSMETIC CONTAINER**

(75) Inventors: **Keiko Tanii, Kobe (JP); Satoshi Yamane, Ashiya (JP)**

(73) Assignee: **The Procter & Gamble Company, Cincinnati, OH (US)**

(**) Term: **14 Years**

(21) Appl. No.: **29/193,812**

(22) Filed: **Nov. 14, 2003**

(30) **Foreign Application Priority Data**

May 16, 2003 (GB) 3012763

(51) **LOC (7) Cl.** **28-02**

(52) **U.S. Cl.** **D28/76**

(58) **Field of Search** D28/73, 76-84,
D28/91; 132/293-307, 313-318, 320; 206/581,
823; D9/529

(56) **References Cited**

U.S. PATENT DOCUMENTS

D210,057 S * 1/1968 Pfrommer D28/76

D420,466 S * 2/2000 Coates et al. D28/76
D471,321 S * 3/2003 Lai D28/82
6,659,109 B2 * 12/2003 Noa 132/317
D485,017 S * 1/2004 Noh D28/76

* cited by examiner

Primary Examiner—Jennifer Rivard

(74) *Attorney, Agent, or Firm*—Vladimir Vitenberg

(57) **CLAIM**

The ornamental design for a cosmetic container, as shown and described.

DESCRIPTION

FIG. 1 is a perspective view of the container embodying the new design;

FIG. 2 is a front view thereof;

FIG. 3 is back view thereof;

FIG. 4 is a top plan view thereof;

FIG. 5 is a bottom view thereof;

FIG. 6 is a left view thereof;

FIG. 7 is a right view thereof; and,

FIG. 8 is an exploded view with the cover shown in an open position.

1 Claim, 3 Drawing Sheets

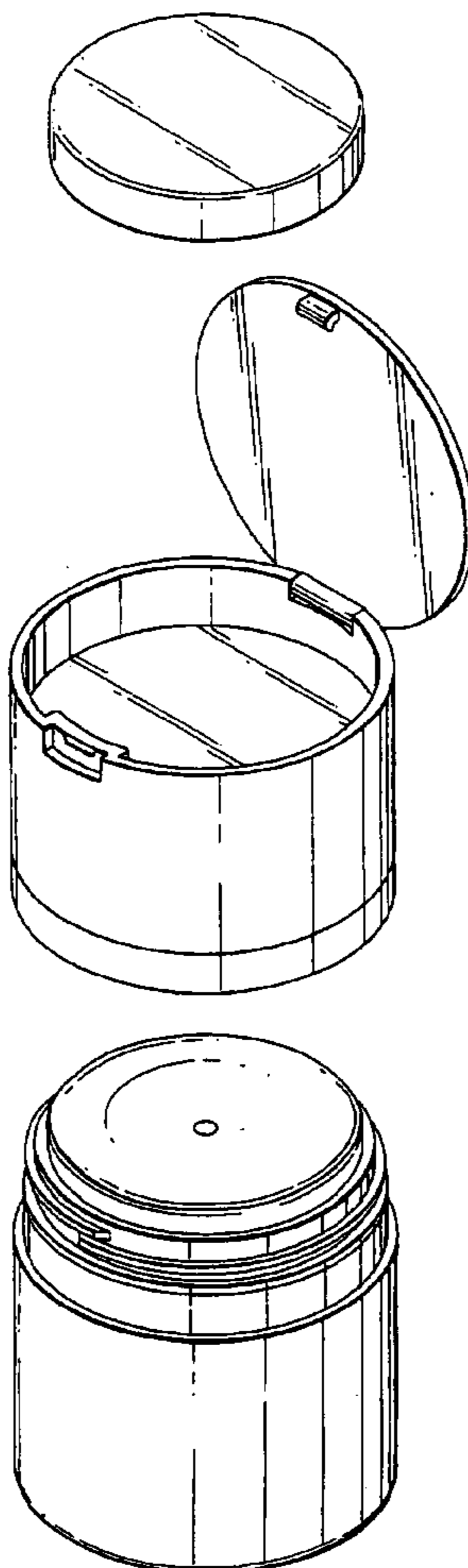

Fig. 1

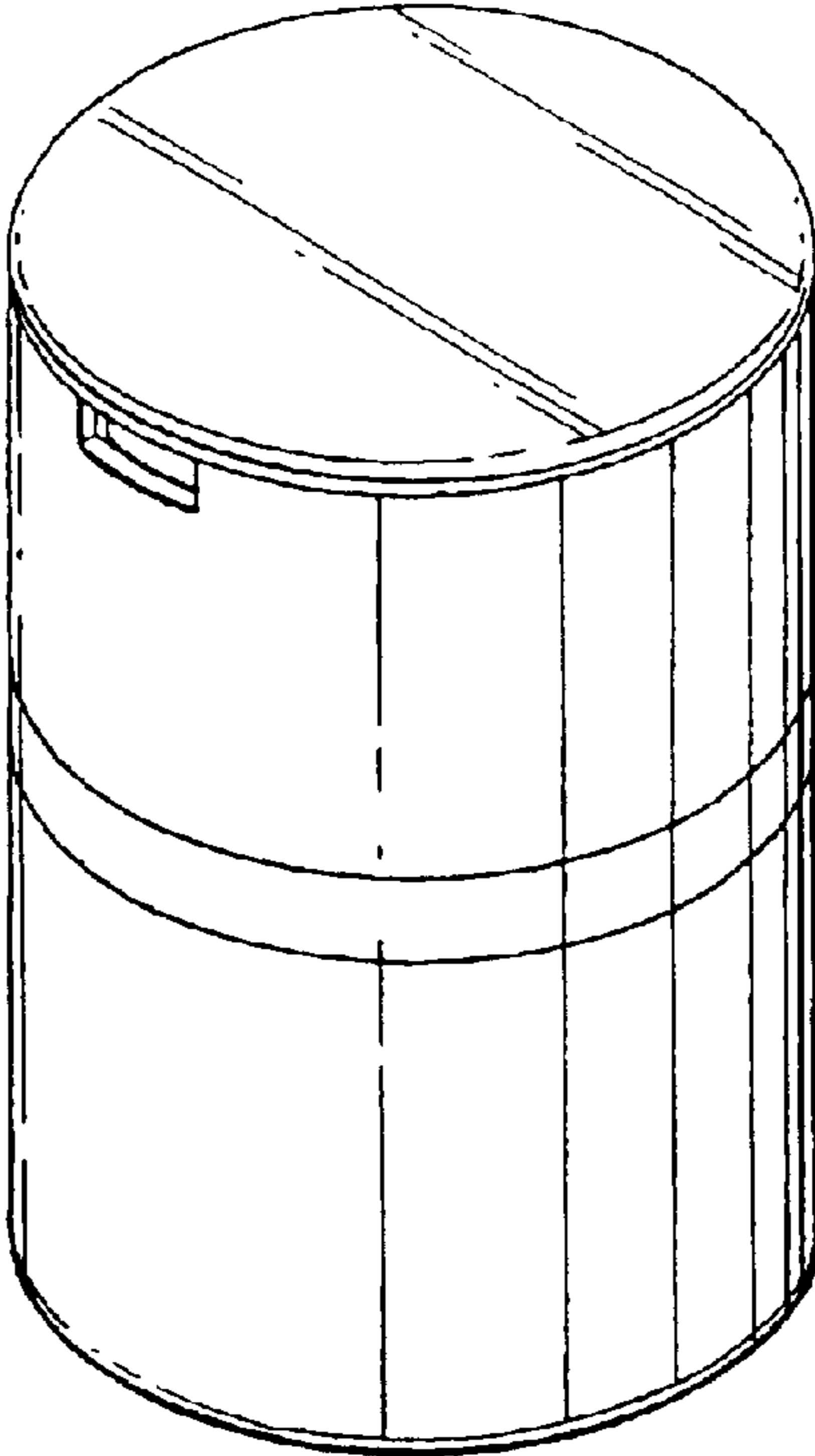

Fig. 2

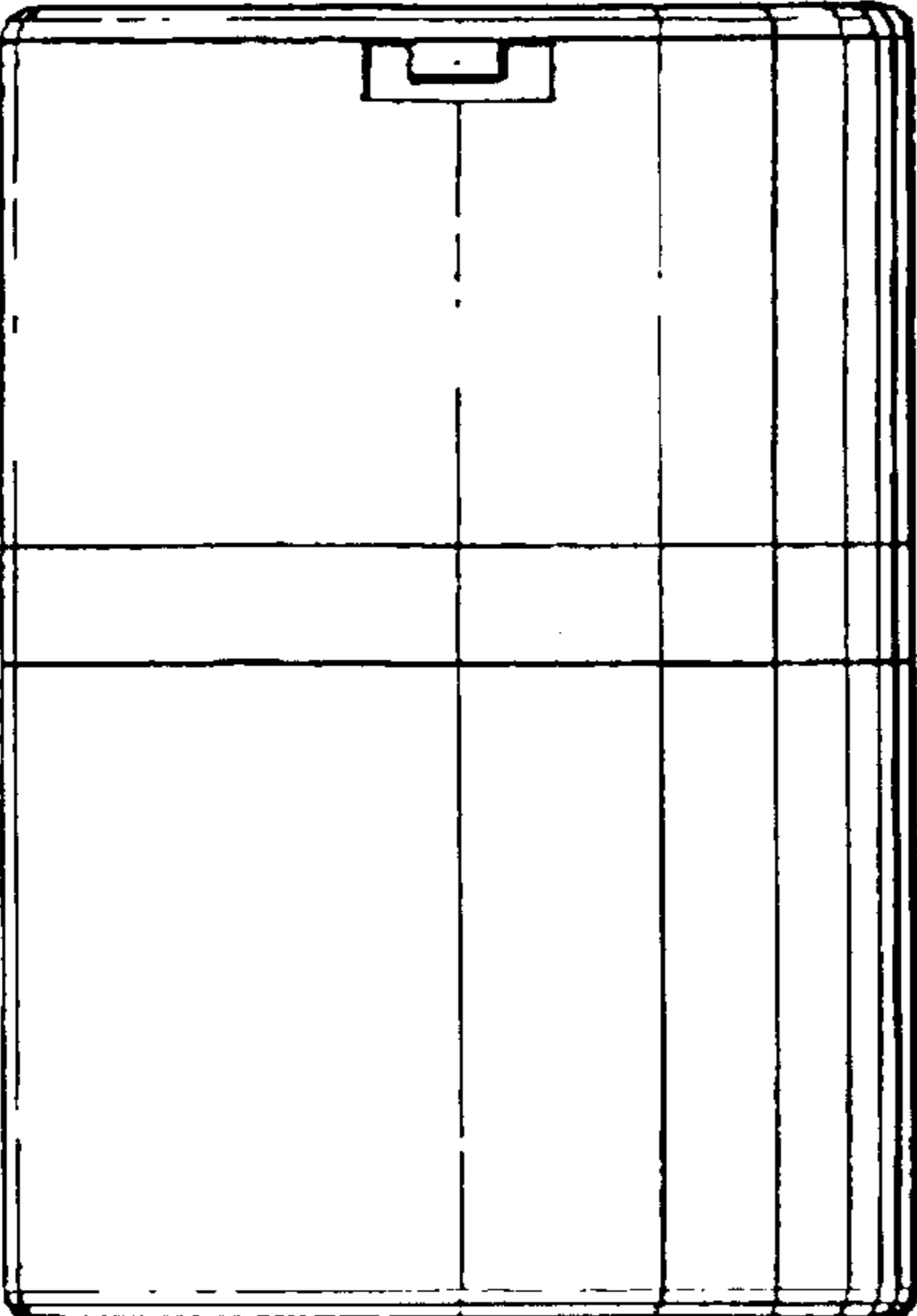

Fig. 3

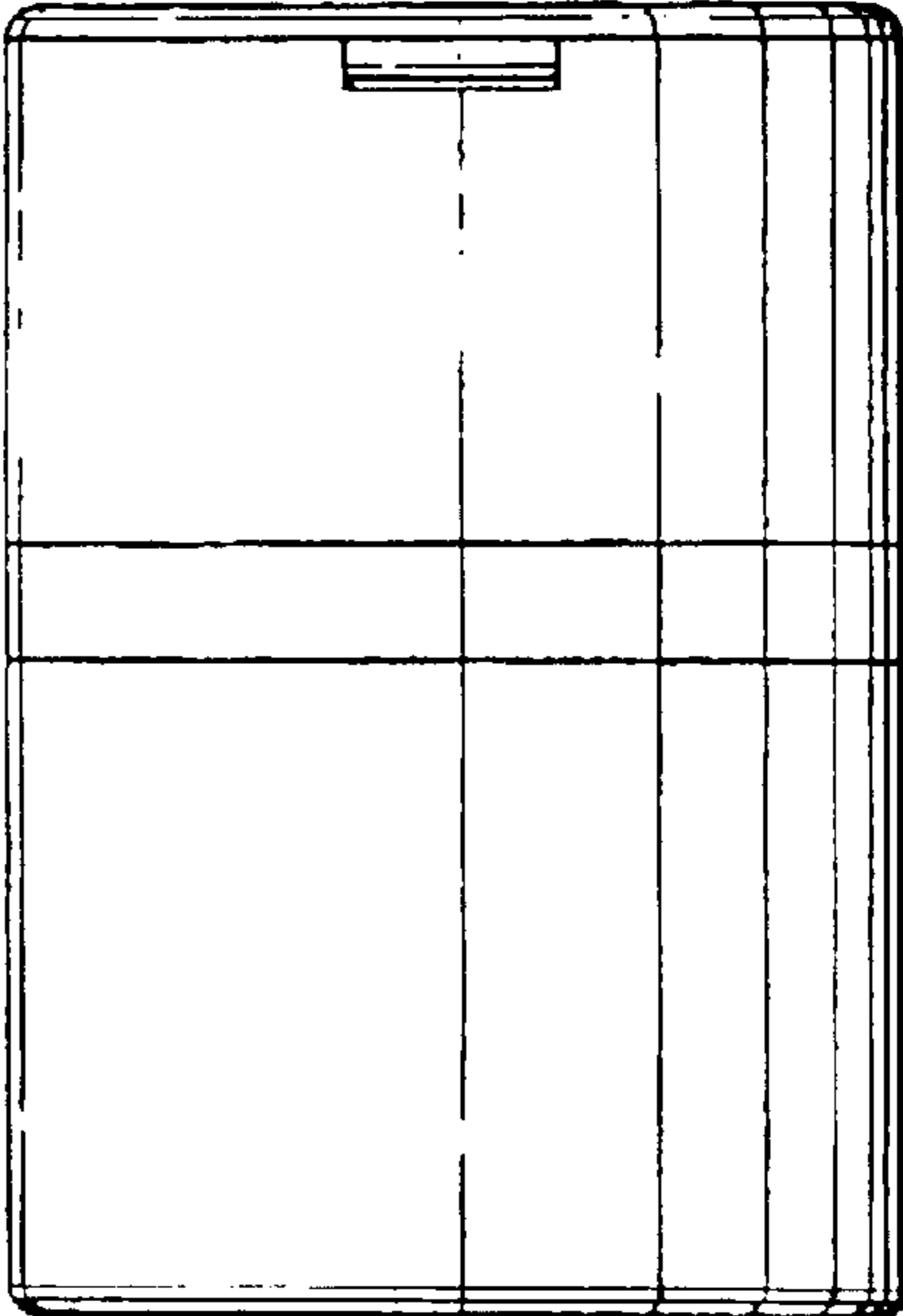

Fig. 4

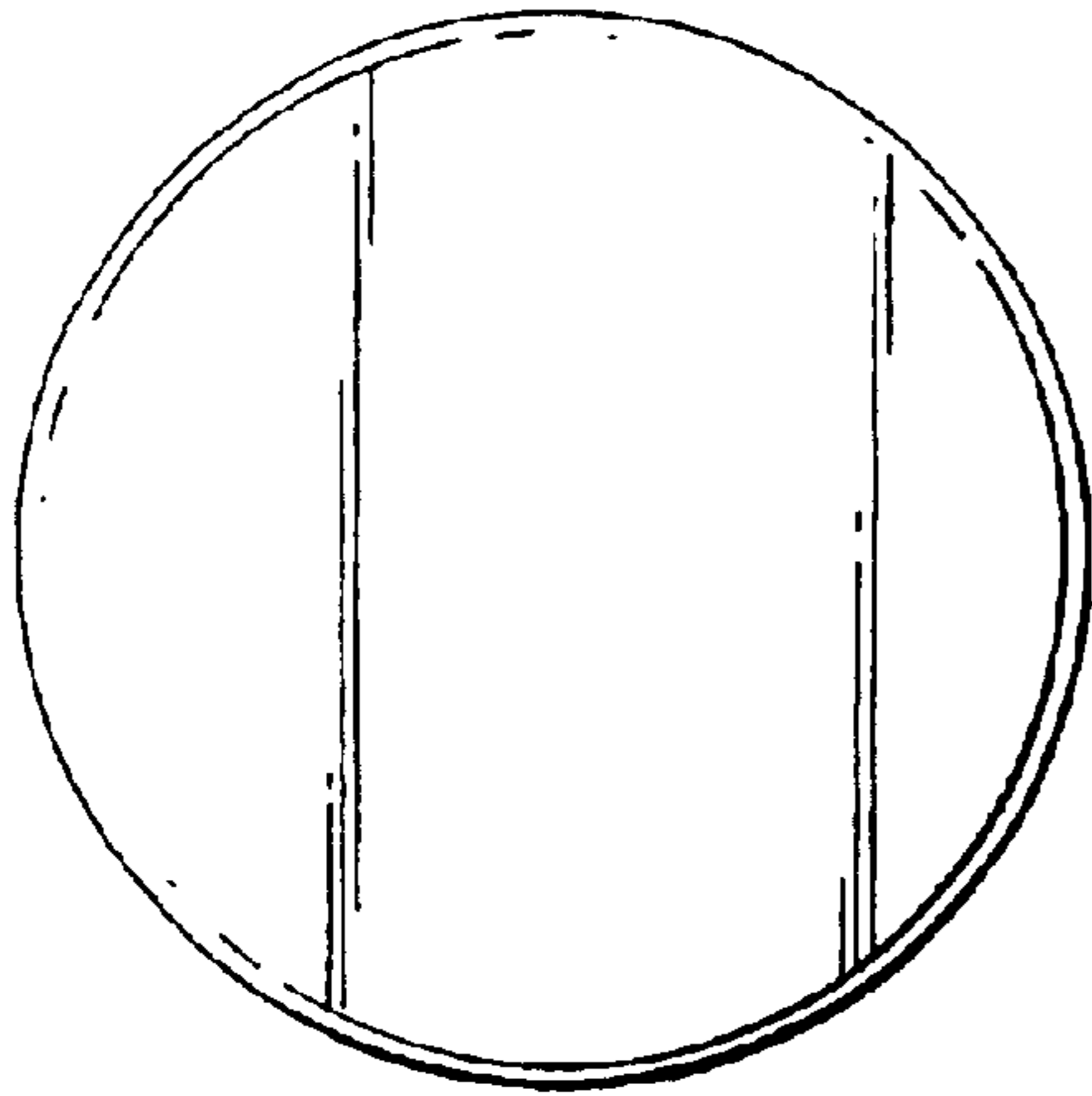

Fig. 5

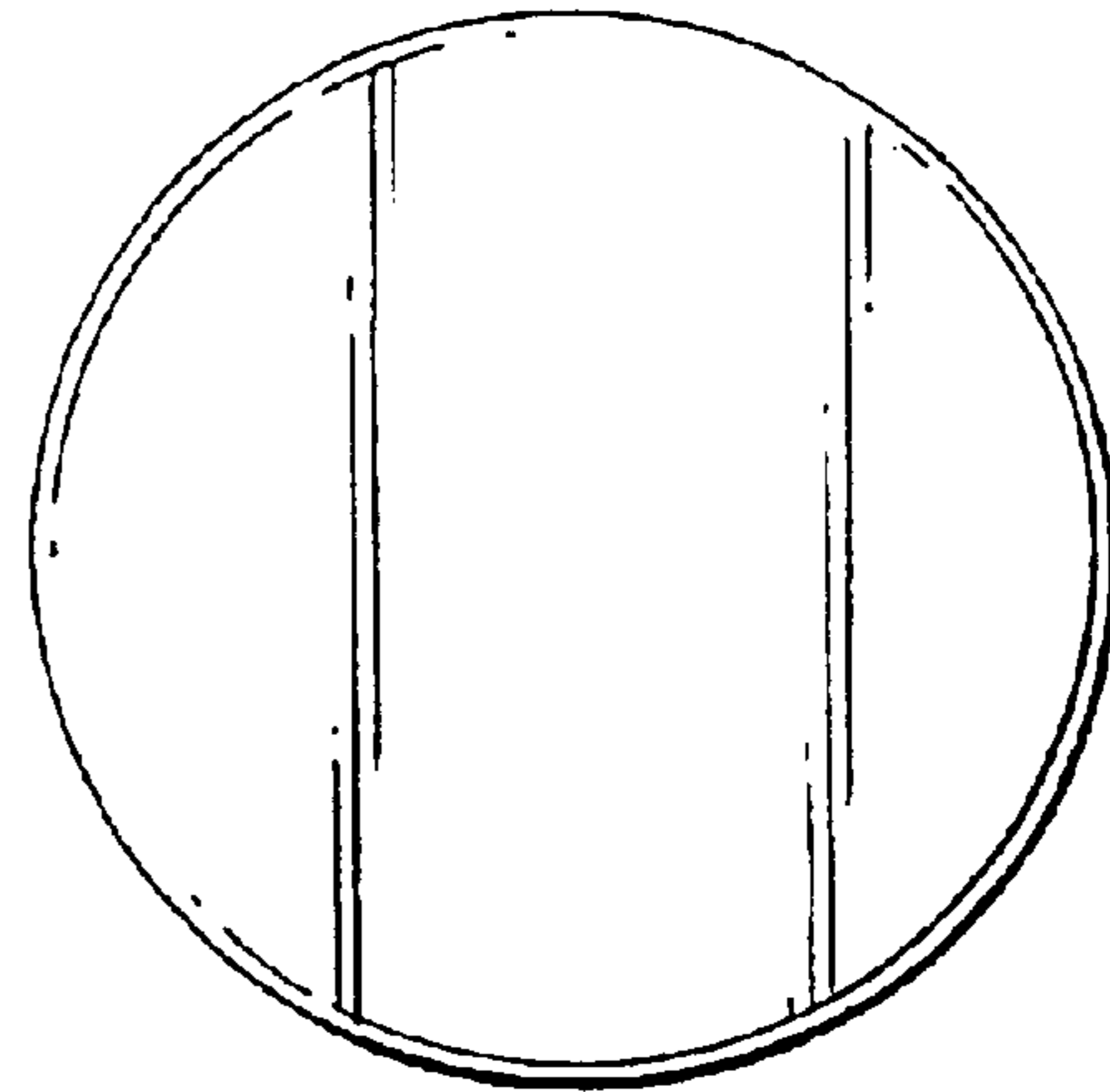

Fig. 6

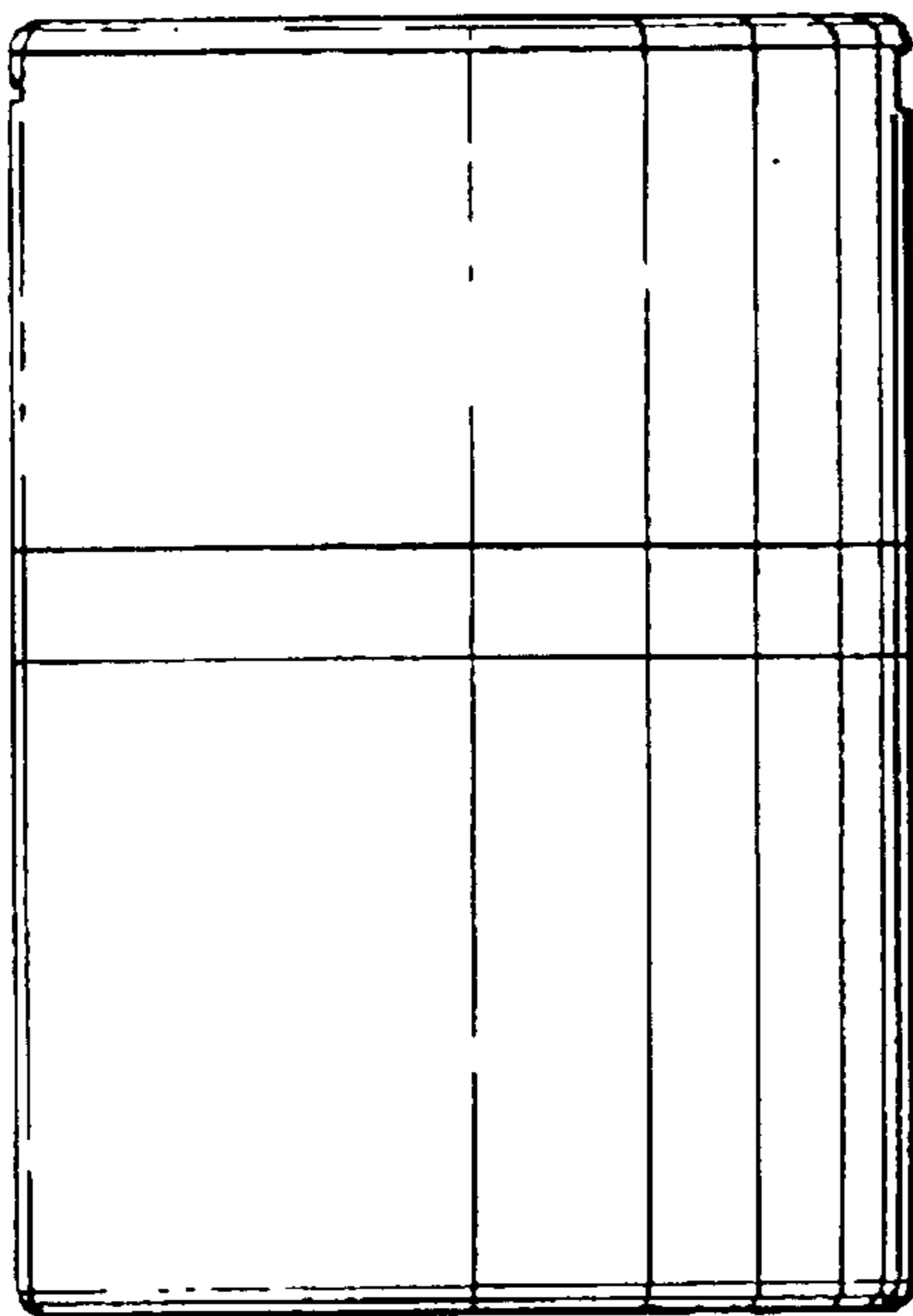

Fig. 7

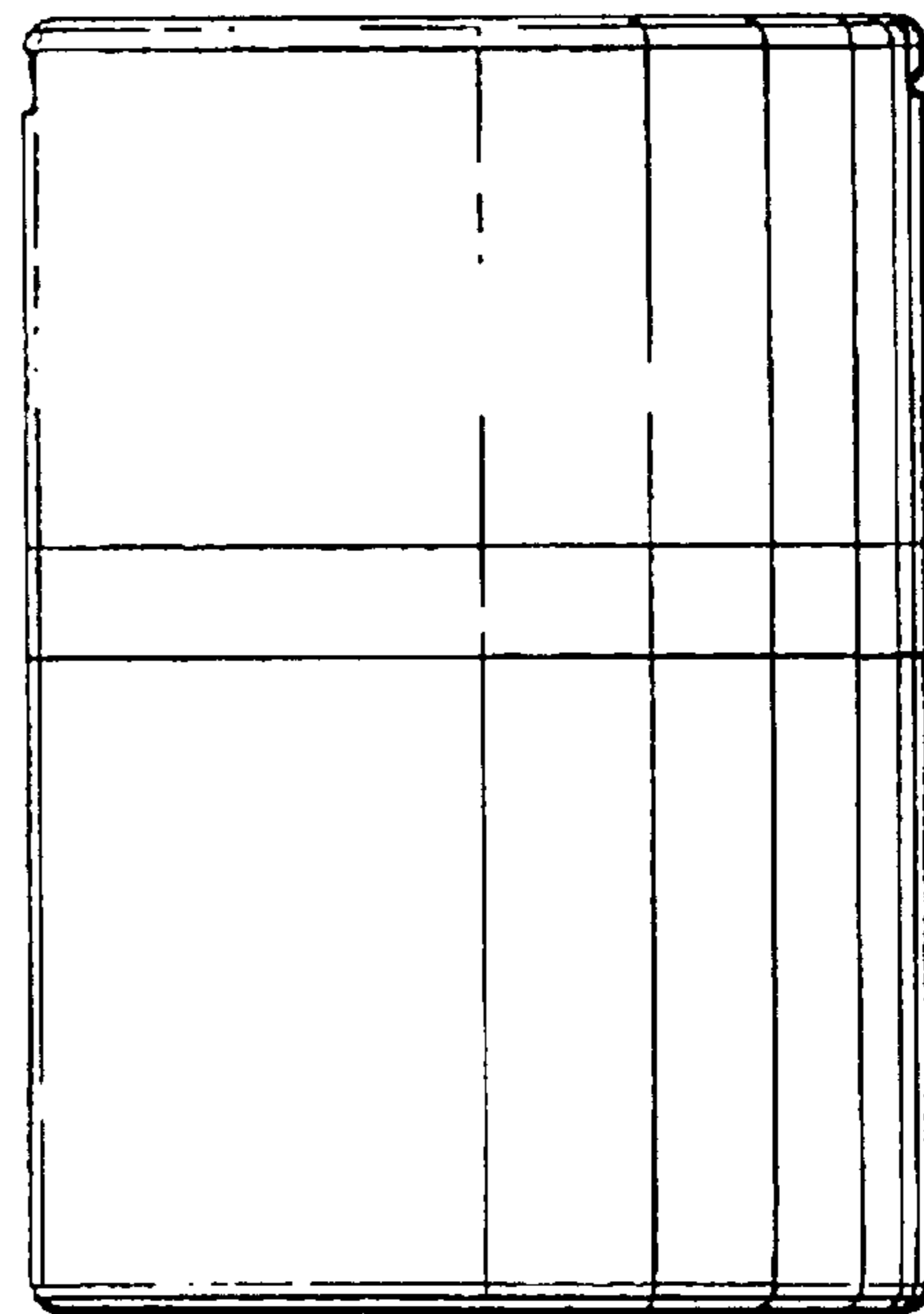

Fig. 8

