

US00D503773S

(12) **United States Design Patent**  
**Alkalay**

(10) **Patent No.:** **US D503,773 S**

(45) **Date of Patent:** **\*\* Apr. 5, 2005**

(54) **PATTERN SPRINKLER**

(75) **Inventor:** **Uri Alkalay, Even Yehuda (IL)**

(73) **Assignee:** **Elgo Irrigation LTD, Netanya (IL)**

(\*\*) **Term:** **14 Years**

(21) **Appl. No.:** **29/194,260**

(22) **Filed:** **Nov. 20, 2003**

(30) **Foreign Application Priority Data**

Jul. 31, 2003 (IL) ..... 38276

(51) **LOC (7) Cl.** ..... **23-01**

(52) **U.S. Cl.** ..... **D23/214**

(58) **Field of Search** ..... D23/213, 214,  
D23/215; 239/273, 276, 275

(56) **References Cited**

**U.S. PATENT DOCUMENTS**

D374,914 S \* 10/1996 Wang ..... D23/214

D383,830 S \* 9/1997 Guo ..... D23/214

D415,248 S \* 10/1999 Roman ..... D23/214

D488,533 S \* 4/2004 Wang ..... D23/214

\* cited by examiner

*Primary Examiner*—Robin V. Taylor

(74) *Attorney, Agent, or Firm*—Marsteller & Associates,  
P.C.

(57) **CLAIM**

The ornamental design for a pattern sprinkler, as shown.

**DESCRIPTION**

FIG. 1 is a top back isomeric view of a pattern sprinkler showing my new design;

FIG. 2 is a bottom view thereof;

FIG. 3 is a top view thereof;

FIG. 4 is a back view thereof;

FIG. 5 is a front view thereof;

FIG. 6 is a side view thereof; and,

FIG. 7 is another side view thereof.

**1 Claim, 7 Drawing Sheets**

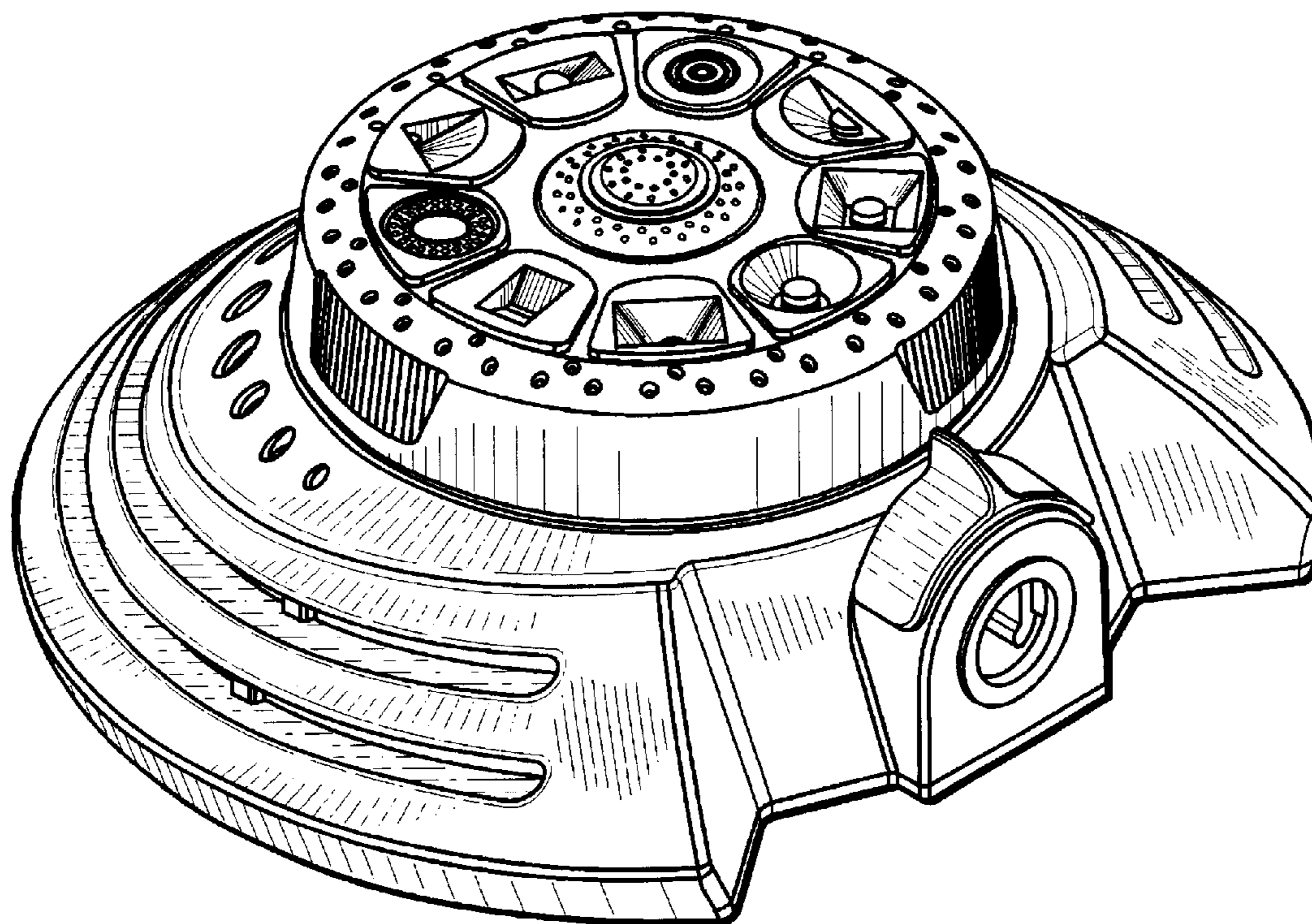

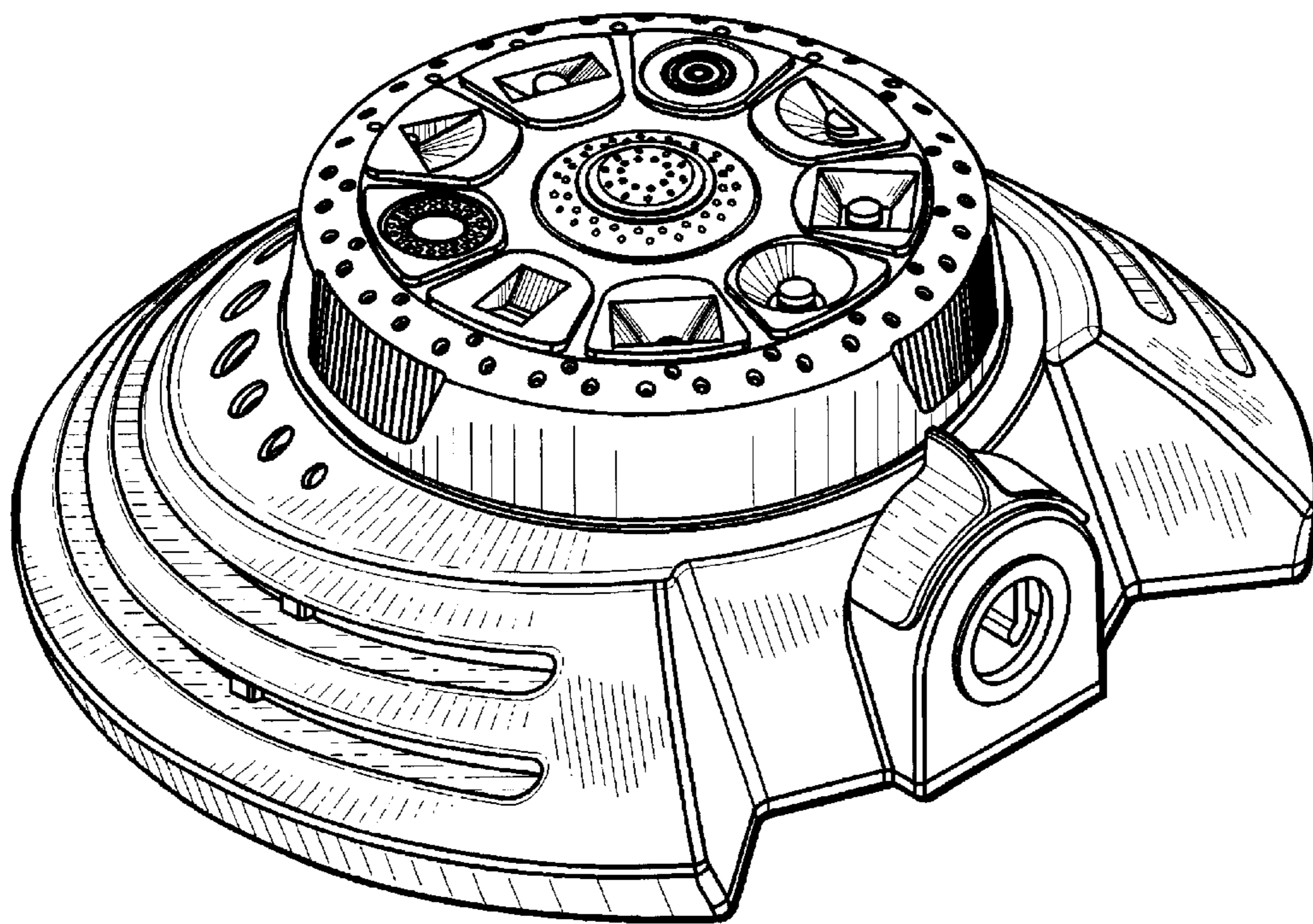

FIG. 1

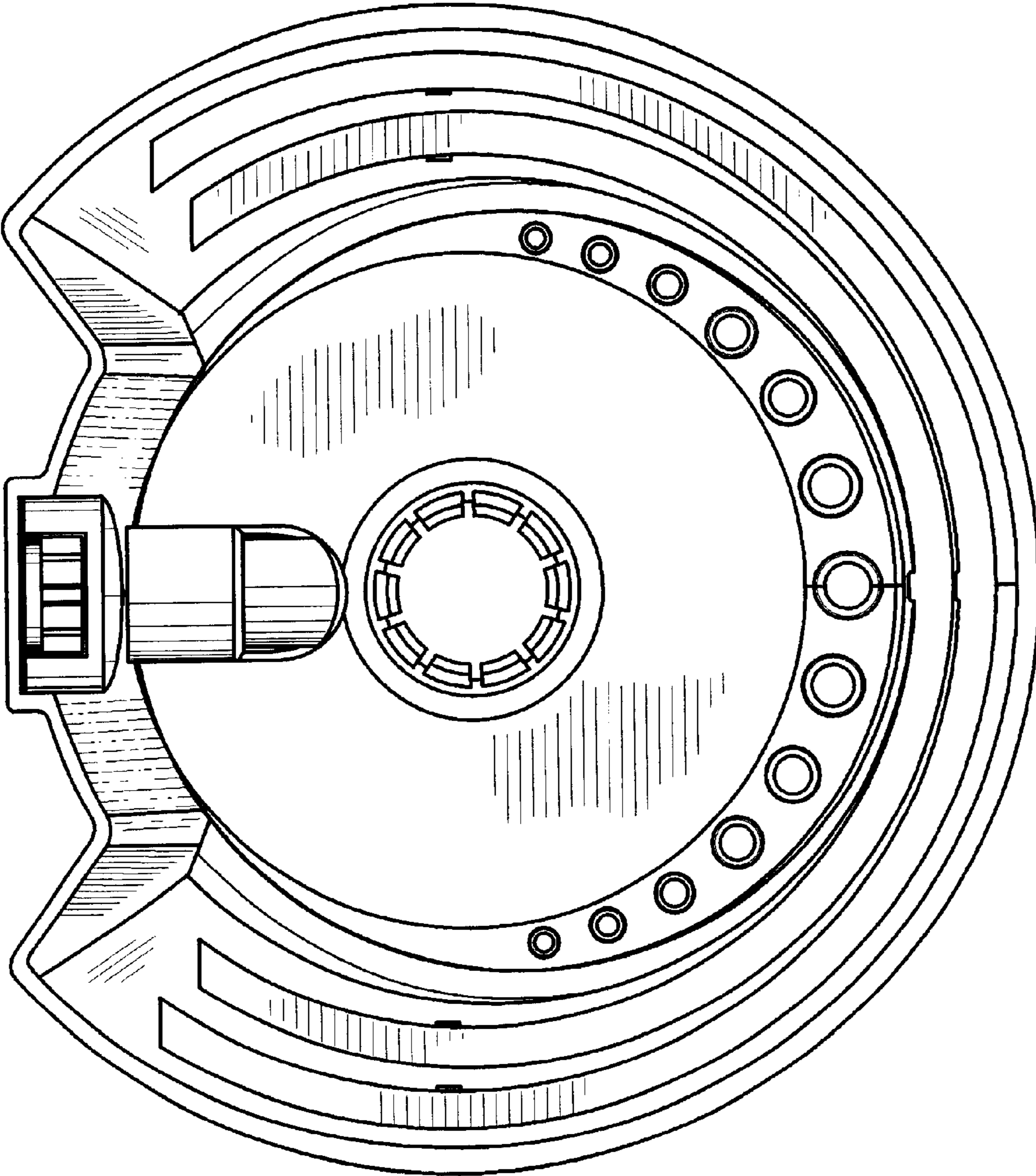

FIG. 2

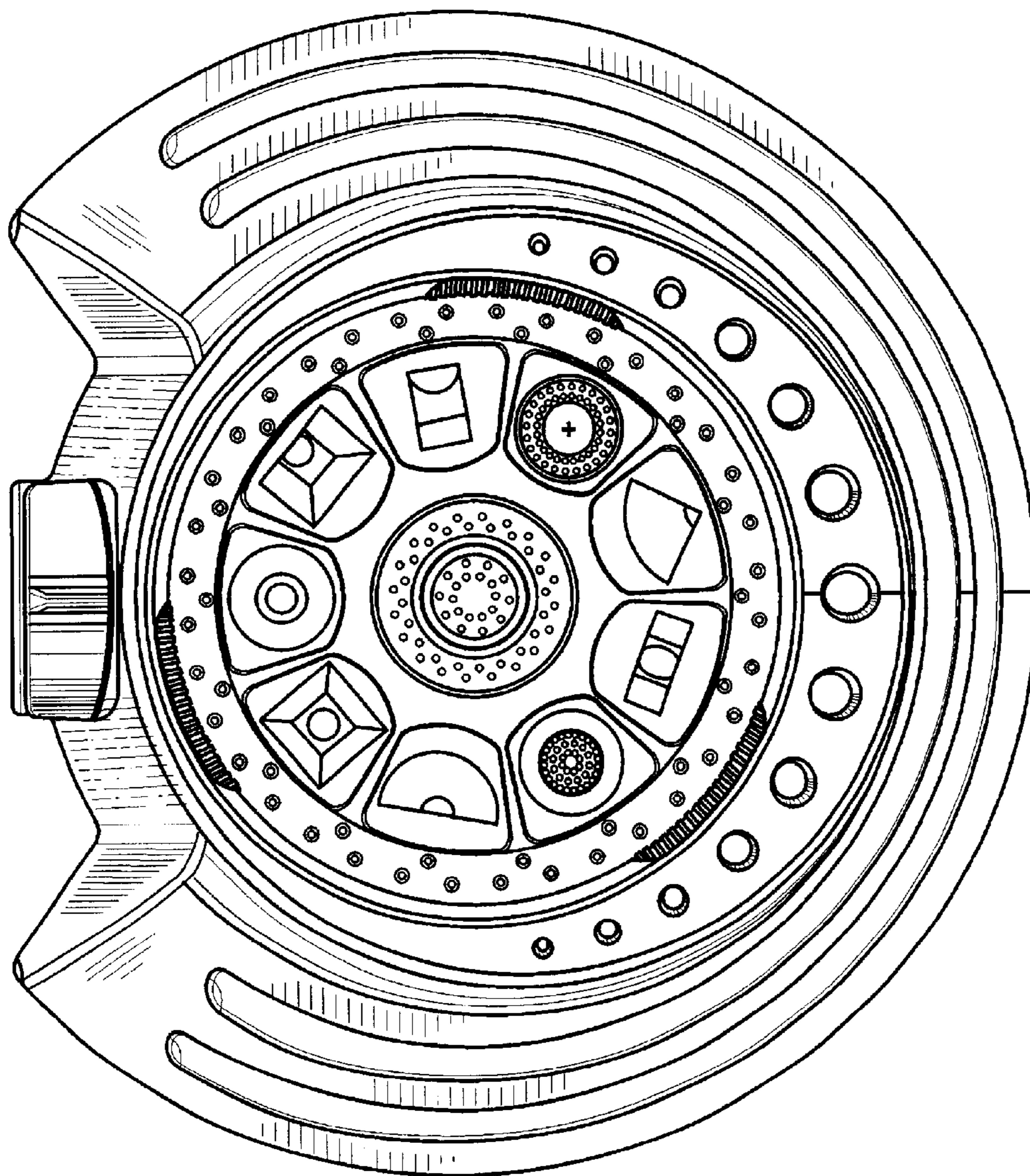

FIG. 3

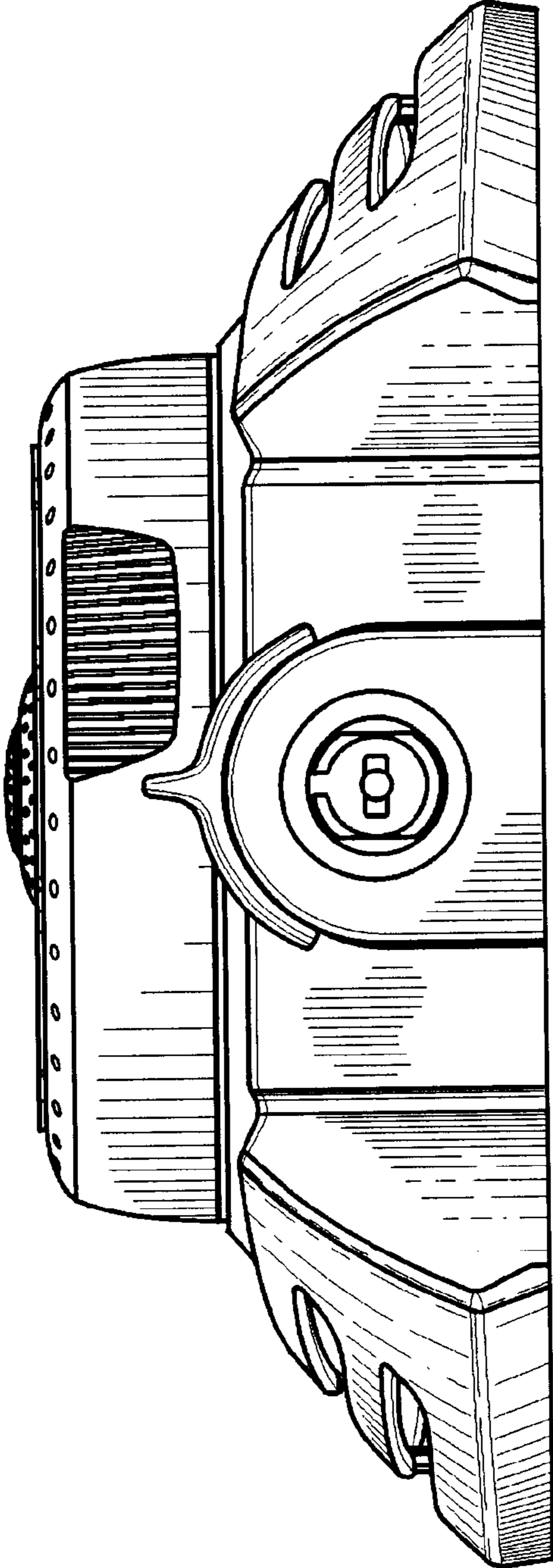

FIG. 4

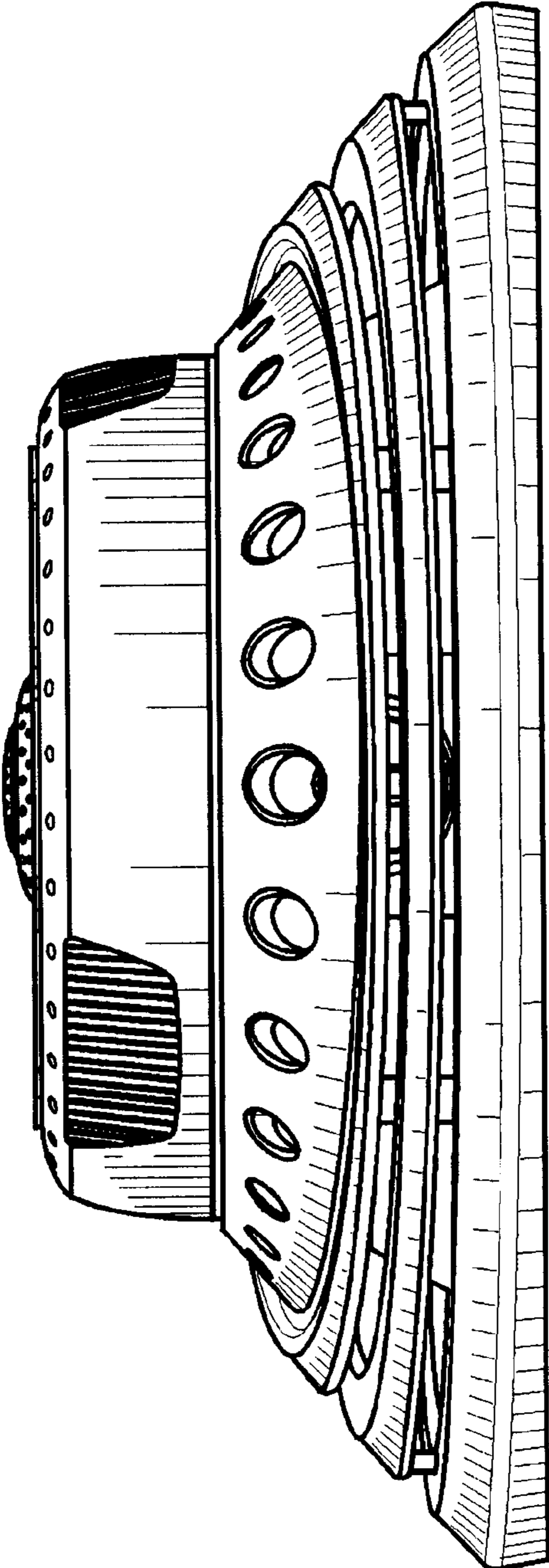

FIG. 5

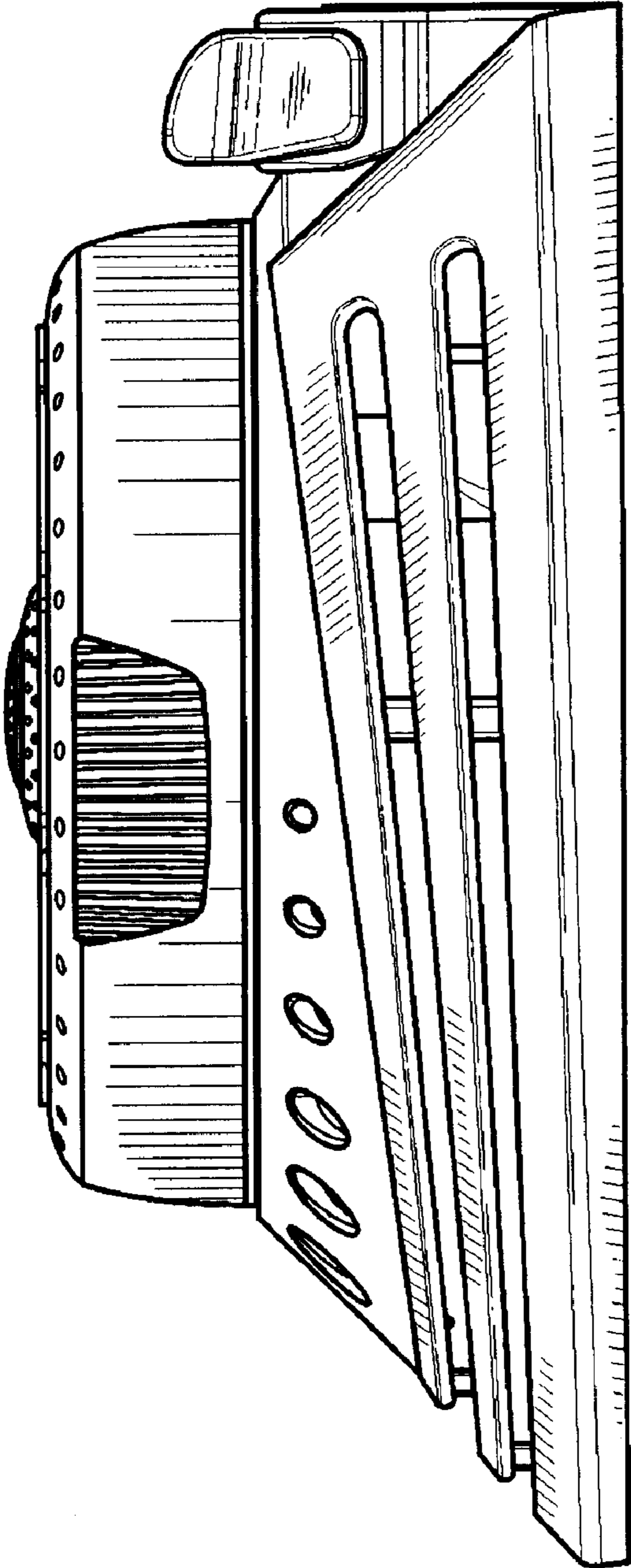

FIG. 6

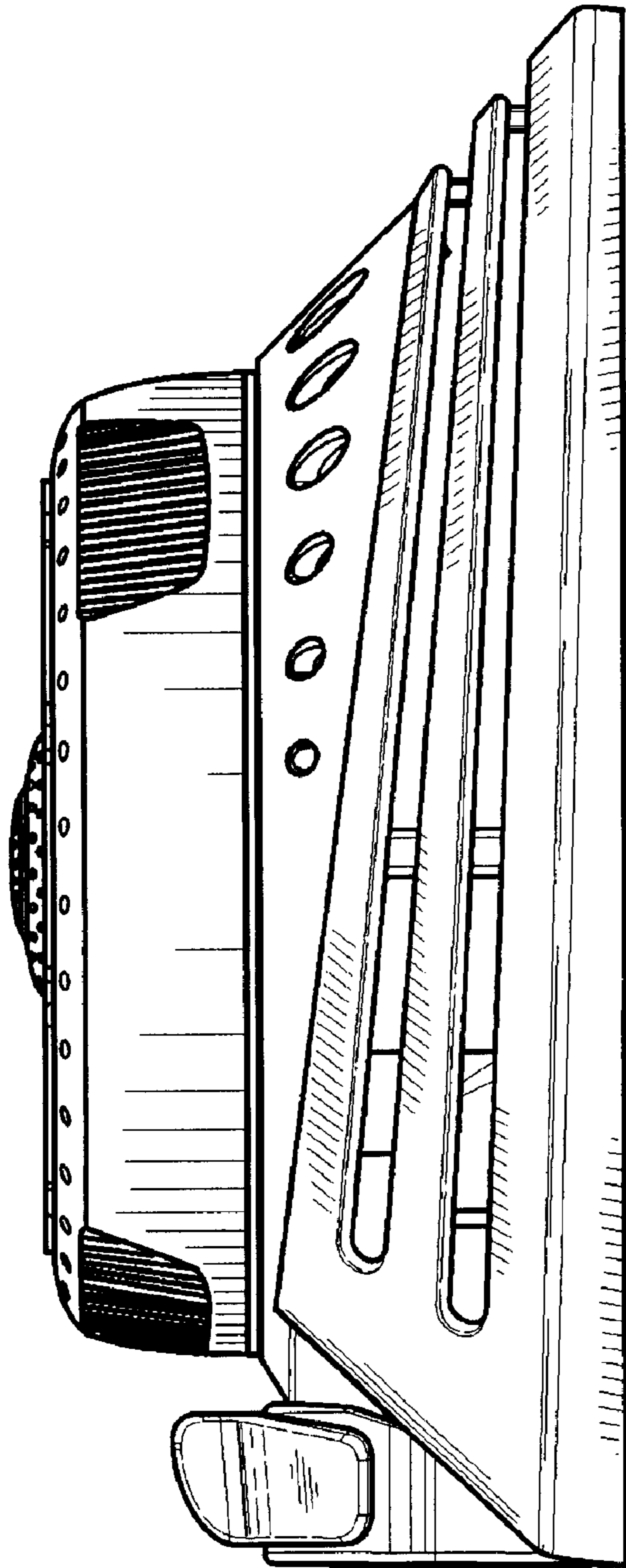

FIG. 7