

US00D503725S

(12) **United States Design Patent**
Ensminger et al.

(10) **Patent No.:** **US D503,725 S**

(45) **Date of Patent:** **** Apr. 5, 2005**

(54) **OIL PAN PLUG WITH DRAIN VALVE FOR VEHICLE**

5,450,835 A 9/1995 Wagner
6,079,694 A * 6/2000 Yoshida 251/324
6,206,032 B1 * 3/2001 Hill 184/105.3
6,318,500 B1 11/2001 Mizani
6,729,600 B2 * 5/2004 Mattes et al. 251/324

(76) Inventors: **Ryan C. Ensminger**, P.O. Box 1,
Underwood, WA (US) 98651-0001;
Eron J. Ensminger, P.O. Box 841,
Washougal, WA (US) 98671-0841

* cited by examiner

(**) **Term:** **14 Years**

Primary Examiner—Antoine D. Davis
(74) *Attorney, Agent, or Firm*—Donald R. Schoonover

(21) **Appl. No.:** **29/196,106**

(57) **CLAIM**

(22) **Filed:** **Dec. 23, 2003**

We claim the ornamental design for an oil pan plug with drain valve for vehicle, as shown and described.

(51) **LOC (7) Cl.** **15-01**

(52) **U.S. Cl.** **D15/5**

(58) **Field of Search** D15/5; 184/1.5,
184/105.3; 123/573; 222/110; 251/100,
324

DESCRIPTION

(56) **References Cited**

U.S. PATENT DOCUMENTS

3,489,312 A 1/1970 Hunckler et al.
4,298,182 A * 11/1981 Balch 184/1.5
4,503,934 A * 3/1985 Stephanus et al. 184/1.5
D301,703 S * 6/1989 Bernstein D12/114
5,048,578 A * 9/1991 Dorf et al. 184/1.5
5,259,588 A 11/1993 Crosby, Jr. et al.
D352,258 S * 11/1994 Rudd et al. D12/126
5,411,115 A 5/1995 Shropshire
5,413,716 A 5/1995 Osborne

FIG. 1 is a perspective view of an oil pan plug with drain valve for vehicle showing our new design;
FIG. 2 is a front elevational view thereof;
FIG. 3 is an elevational view of all sides wherein a lever and slot thereof are not visible;
FIG. 4 is another side elevational view wherein the lever and slot thereof are visible;
FIG. 5 is a top plan view thereof;
FIG. 6 is a bottom plan view thereof; and,
FIG. 7 is a perspective view showing the oil pan plug with drain valve for vehicle in use; the broken lines depict environmental structure for illustrative purposes only and form no part of the claimed design.

1 Claim, 4 Drawing Sheets

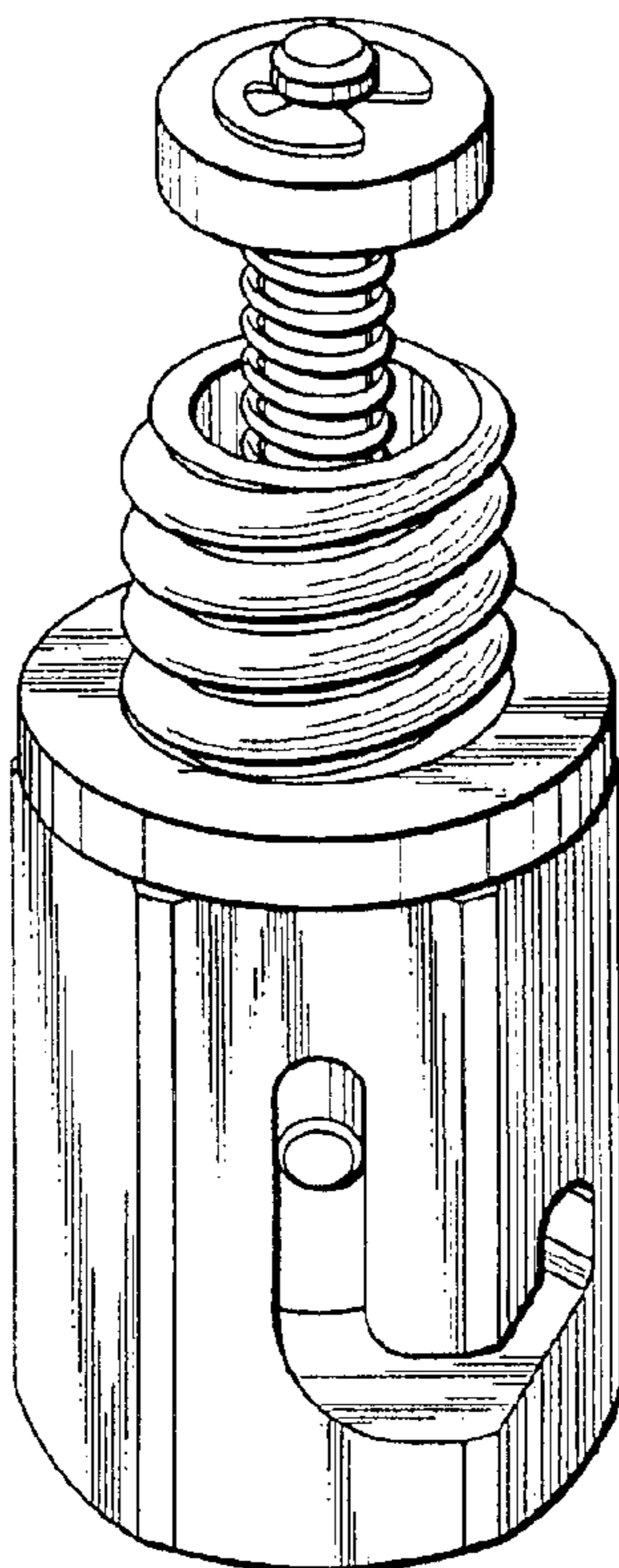

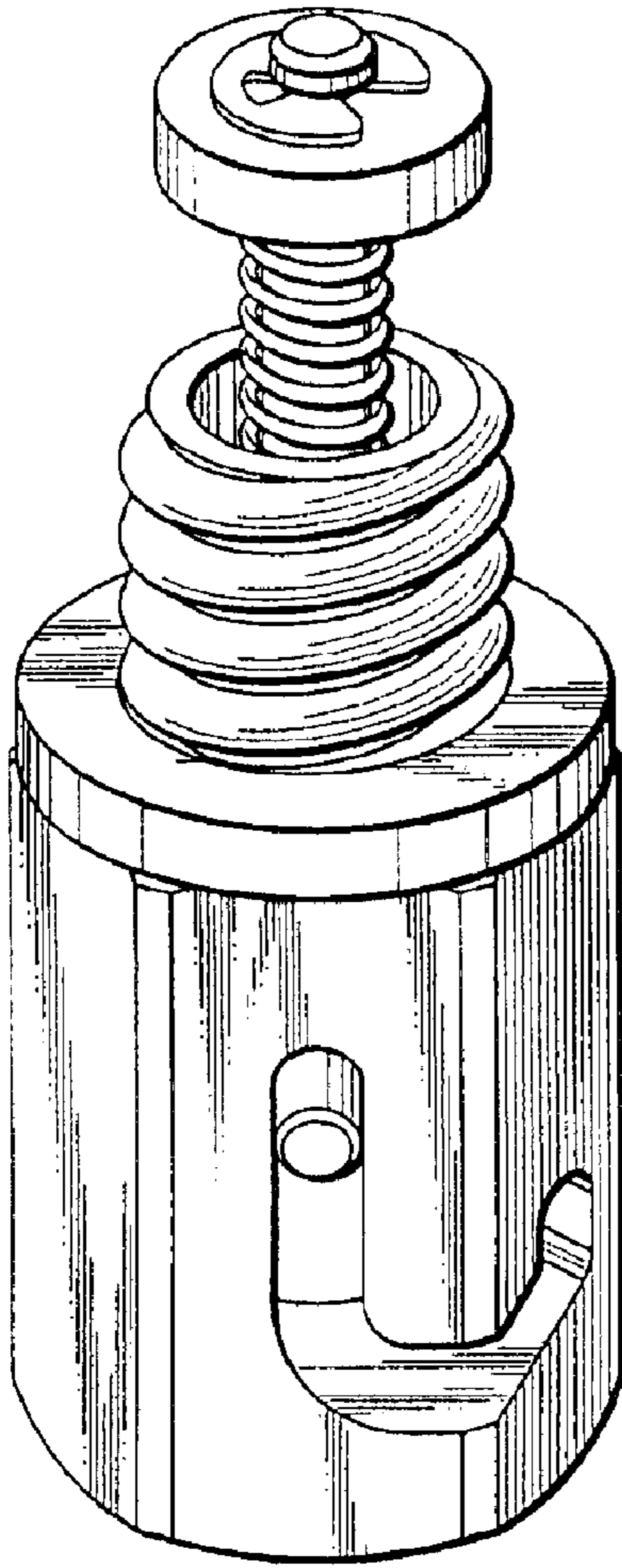

FIG. 1

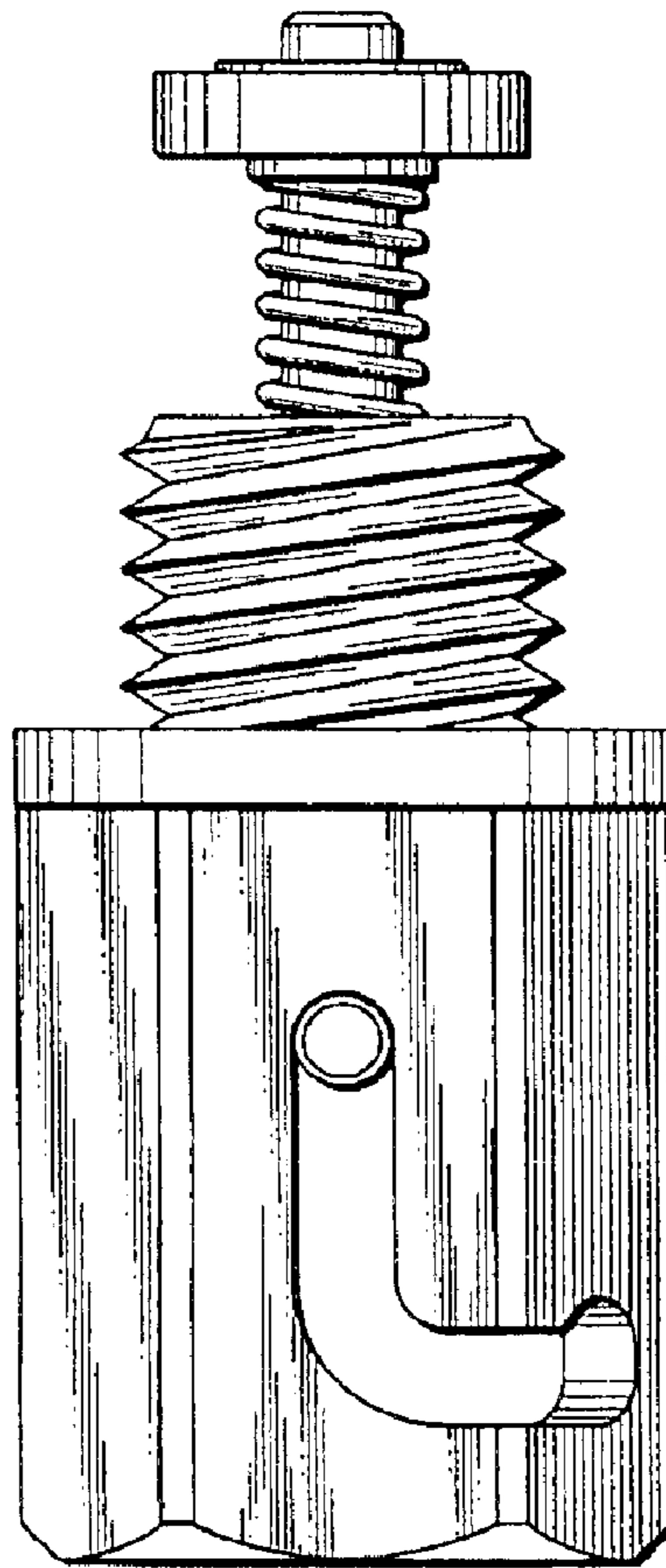

FIG. 2

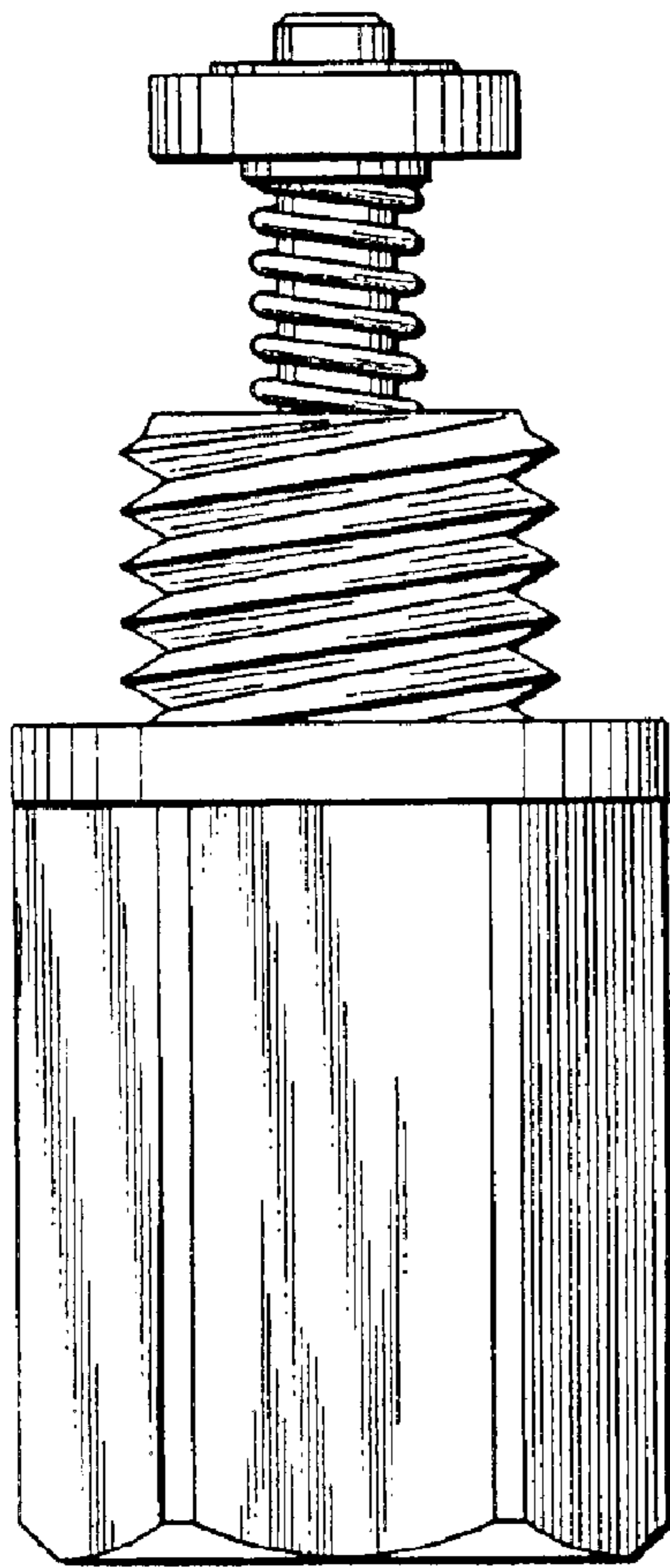

FIG. 3

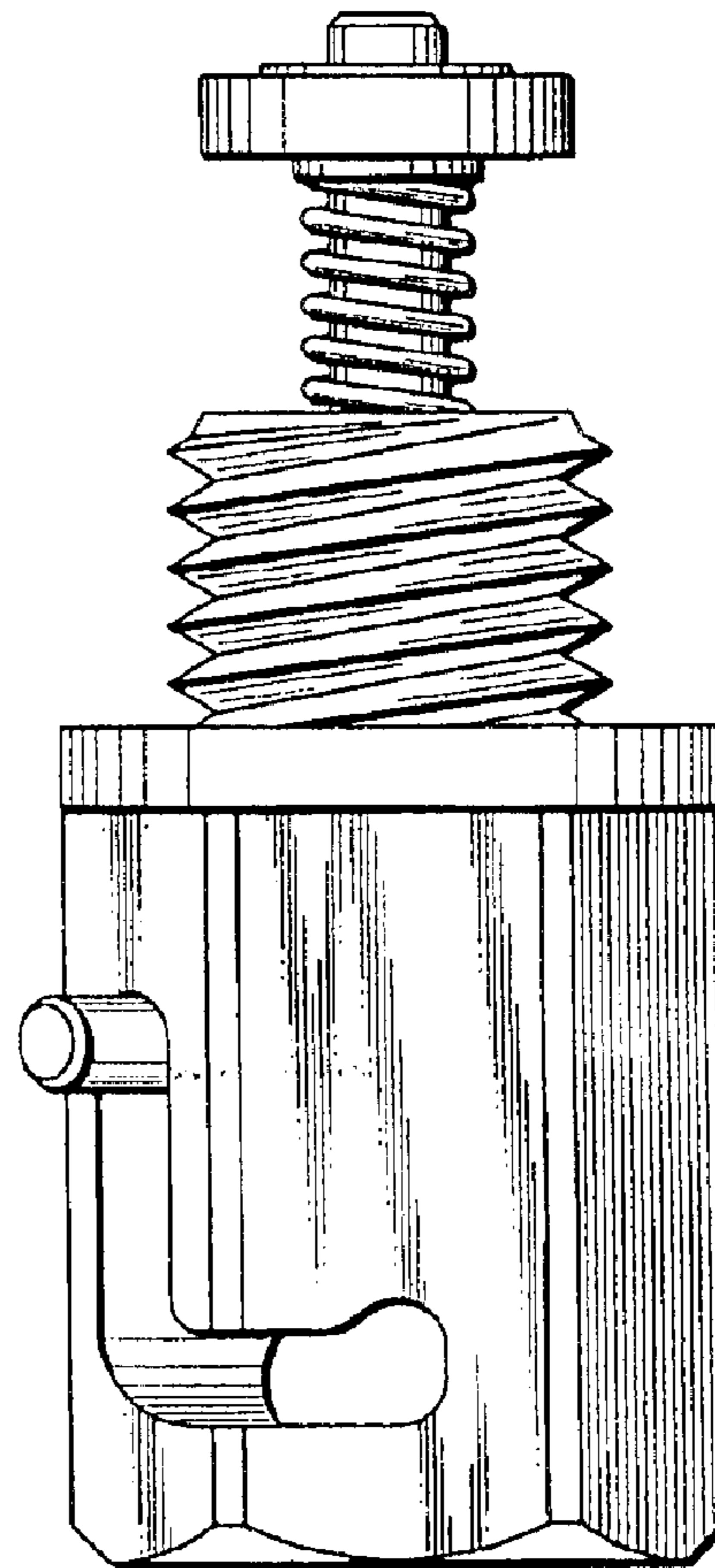
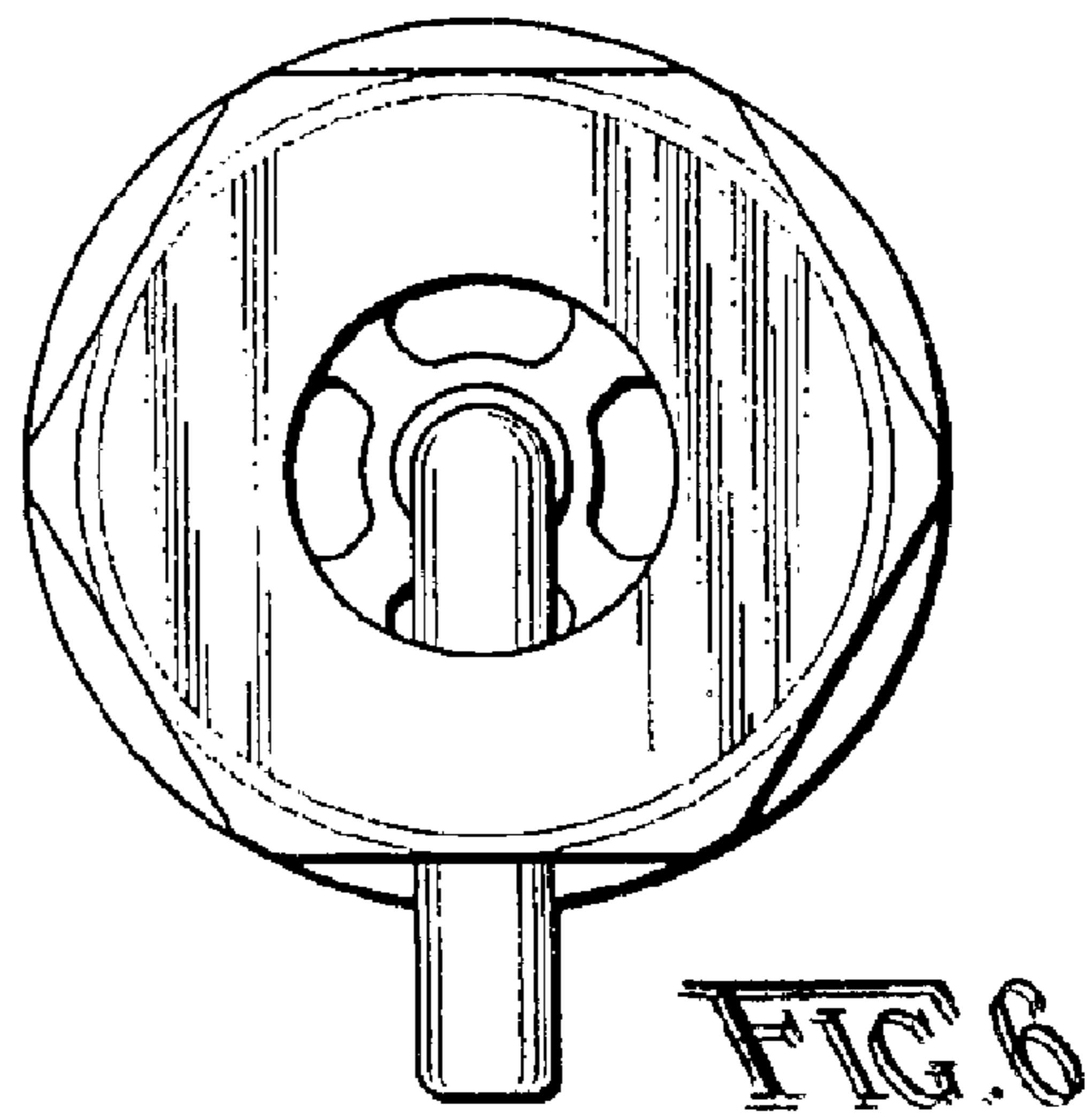
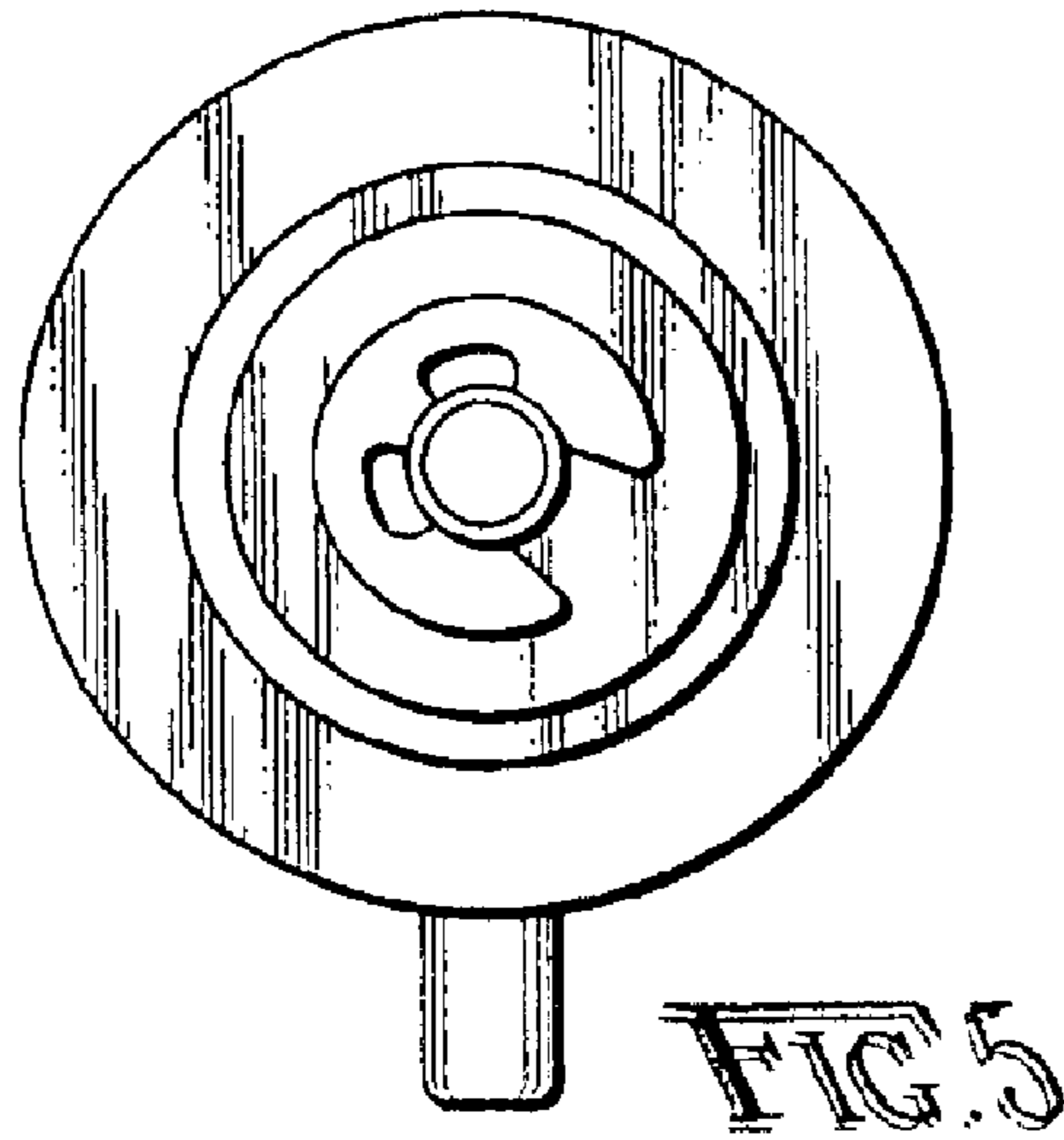

FIG. 4



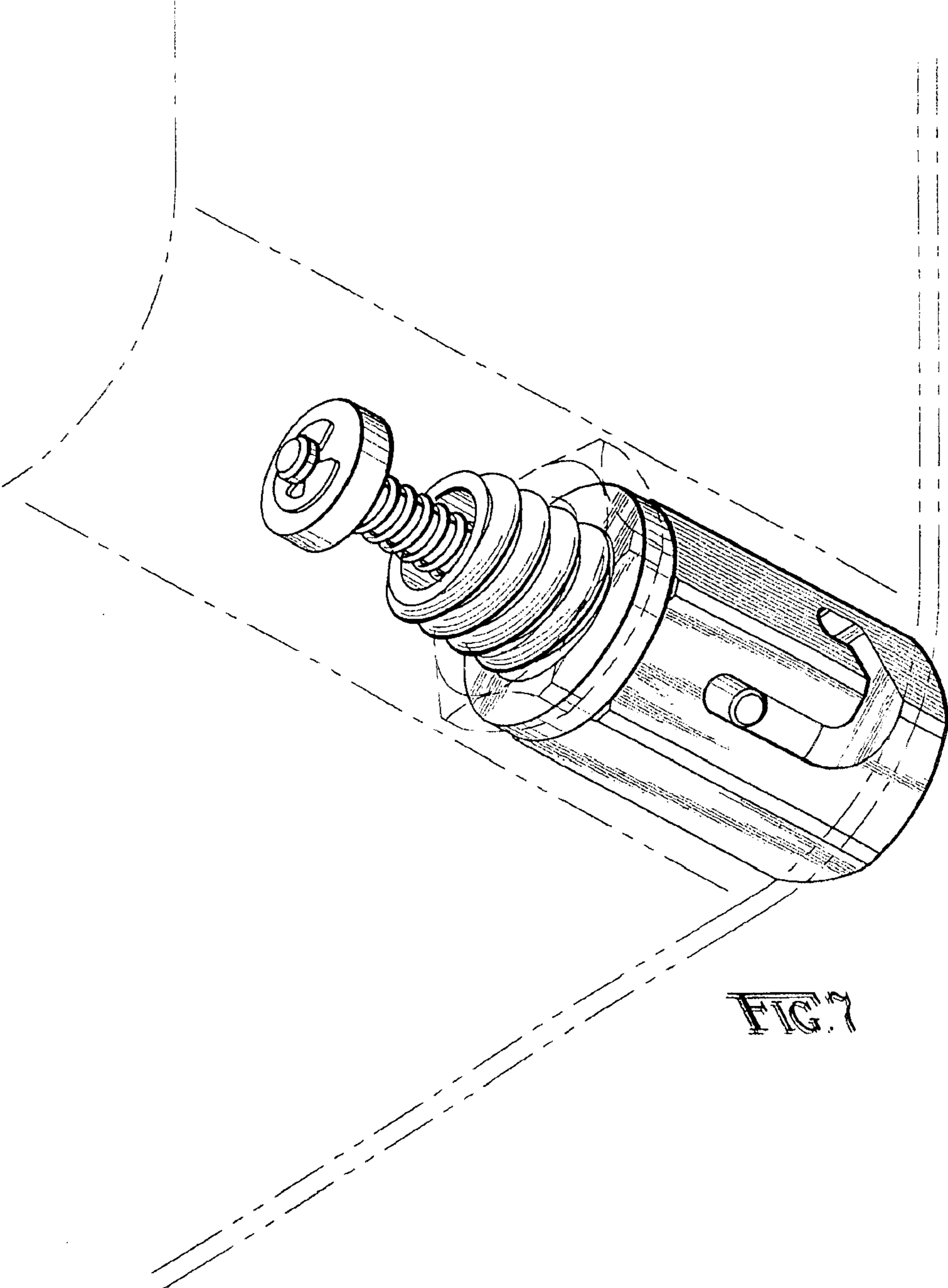

FIG. 7