

US00D503722S

(12) **United States Design Patent**
Stenz et al.

(10) **Patent No.:** **US D503,722 S**

(45) **Date of Patent:** **** Apr. 5, 2005**

(54) **ENGINE**

(75) Inventors: **Dennis Stenz**, Mt. Calvary, WI (US);
James Peterson, Brentwood, TN (US)

(73) Assignee: **Murray, Inc.**, Brentwood, TN (US)

(**) Term: **14 Years**

(21) Appl. No.: **29/194,463**

(22) Filed: **Nov. 26, 2003**

(51) **LOC (7) Cl.** **15-01**

(52) **U.S. Cl.** **D15/1**

(58) **Field of Search** D15/1-5; 123/41.7,
123/50 A, 56, 198 E, 306, 308, 661, 667

(56) **References Cited**

U.S. PATENT DOCUMENTS

D396,476 S	*	7/1998	Shimizu	D15/1
D406,146 S	*	2/1999	Kobayashi	D15/1
D414,498 S	*	9/1999	Yoshida	D15/1
D421,024 S	*	2/2000	Katoh	D15/1
D444,478 S	*	7/2001	Shimizu	D15/1
D479,244 S	*	9/2003	Kern et al.	D15/5
D479,721 S	*	9/2003	Kern et al.	D15/5

D491,192 S	*	6/2004	Davis	D15/1
D491,193 S	*	6/2004	Davis	D15/1
D493,806 S	*	8/2004	Csiki	D15/1

* cited by examiner

Primary Examiner—Melody N. Brown

(74) *Attorney, Agent, or Firm*—Pillsbury Winthrop LLP

(57) **CLAIM**

The ornamental design for an engine, as shown and described.

DESCRIPTION

FIG. 1 is a top view of an engine according to an embodiment of our design;

FIG. 2 is a bottom view thereof;

FIG. 3 is a front view thereof;

FIG. 4 is a rear view thereof;

FIG. 5 is a right side view thereof; and,

FIG. 6 is a left side view thereof.

The broken lines shown in FIGS. 1-6 disclose unclaimed subject matter, are for environmental purposes only, and thus form no part of the claimed design.

1 Claim, 6 Drawing Sheets

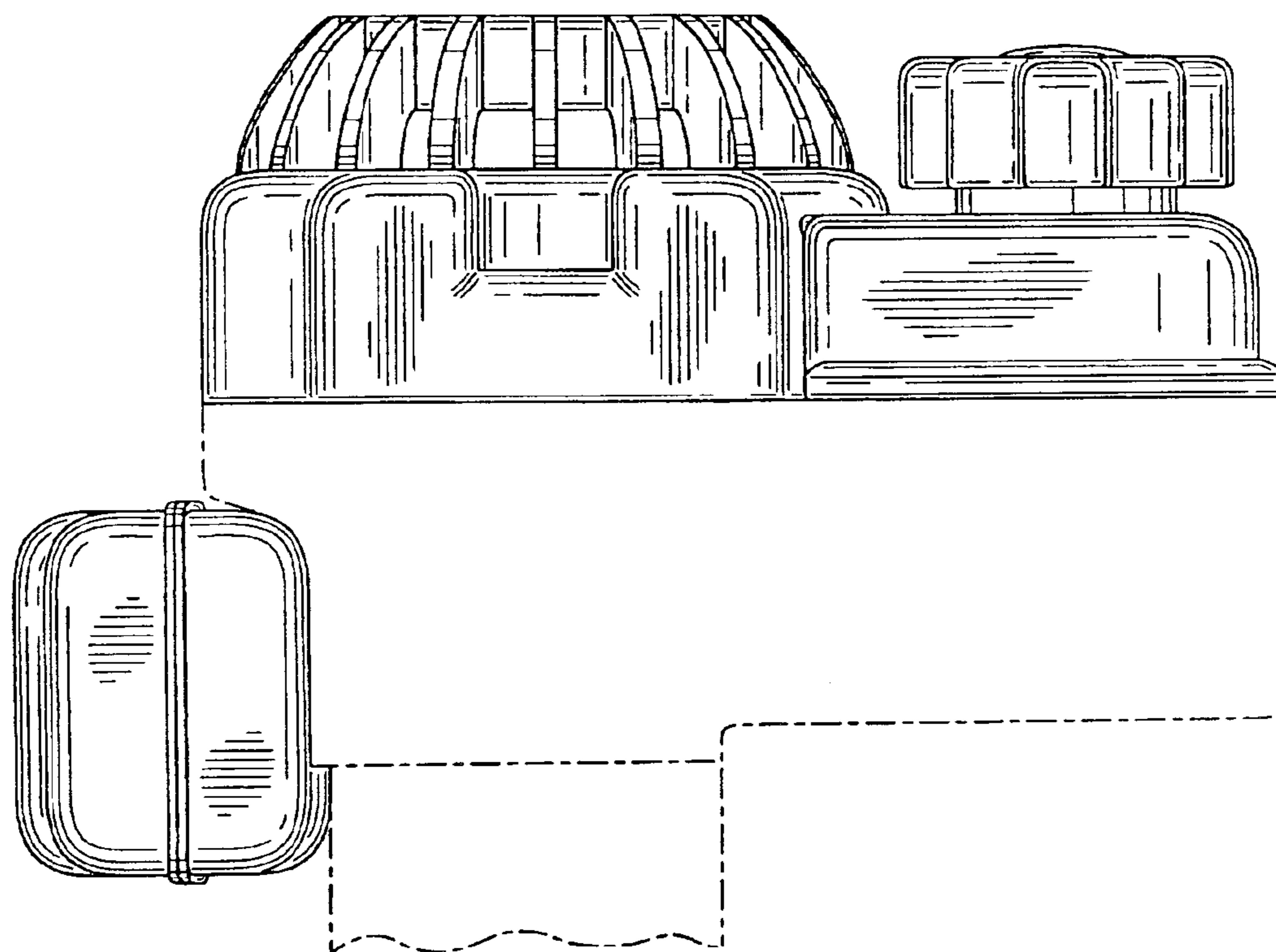

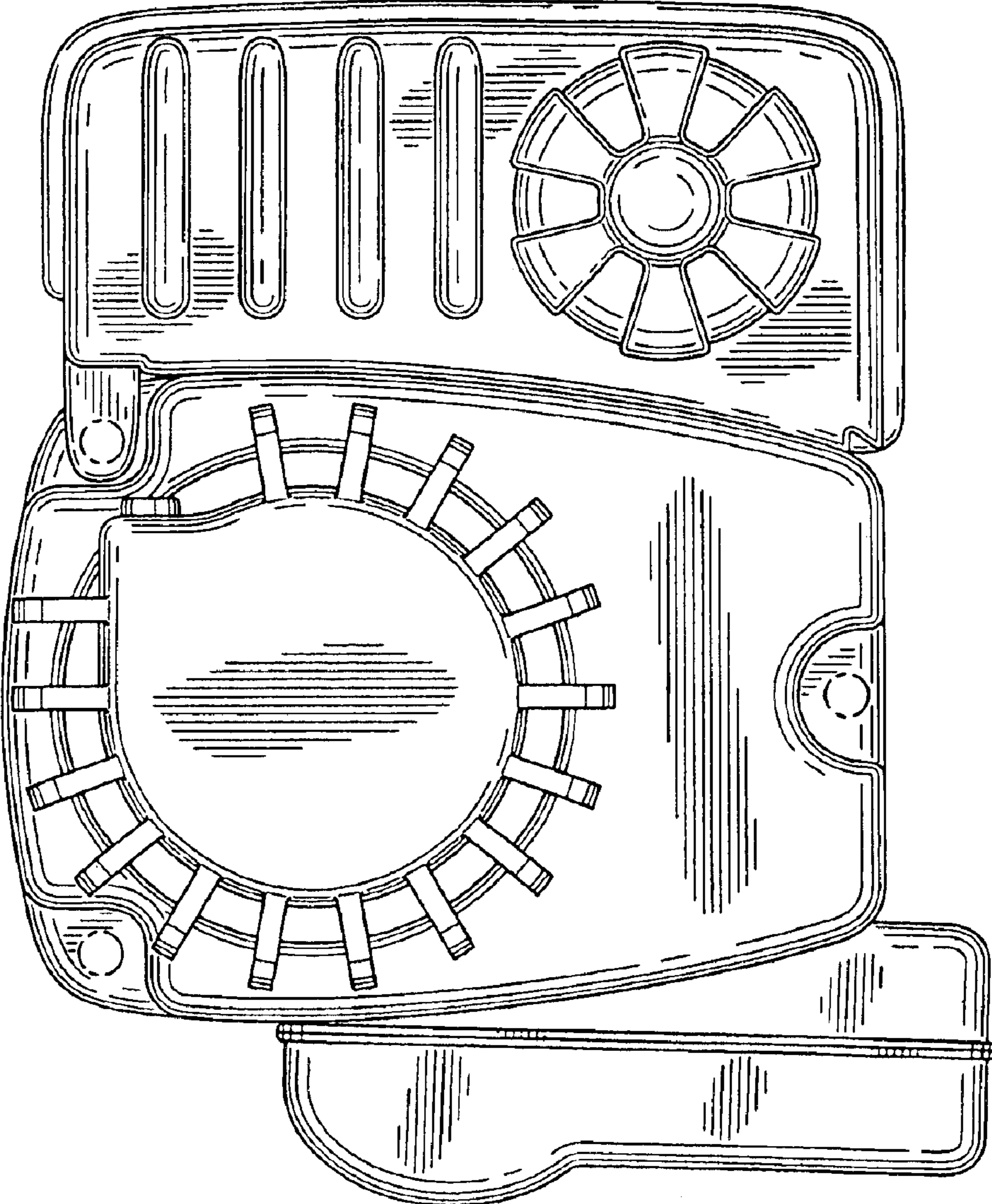

FIG. 1

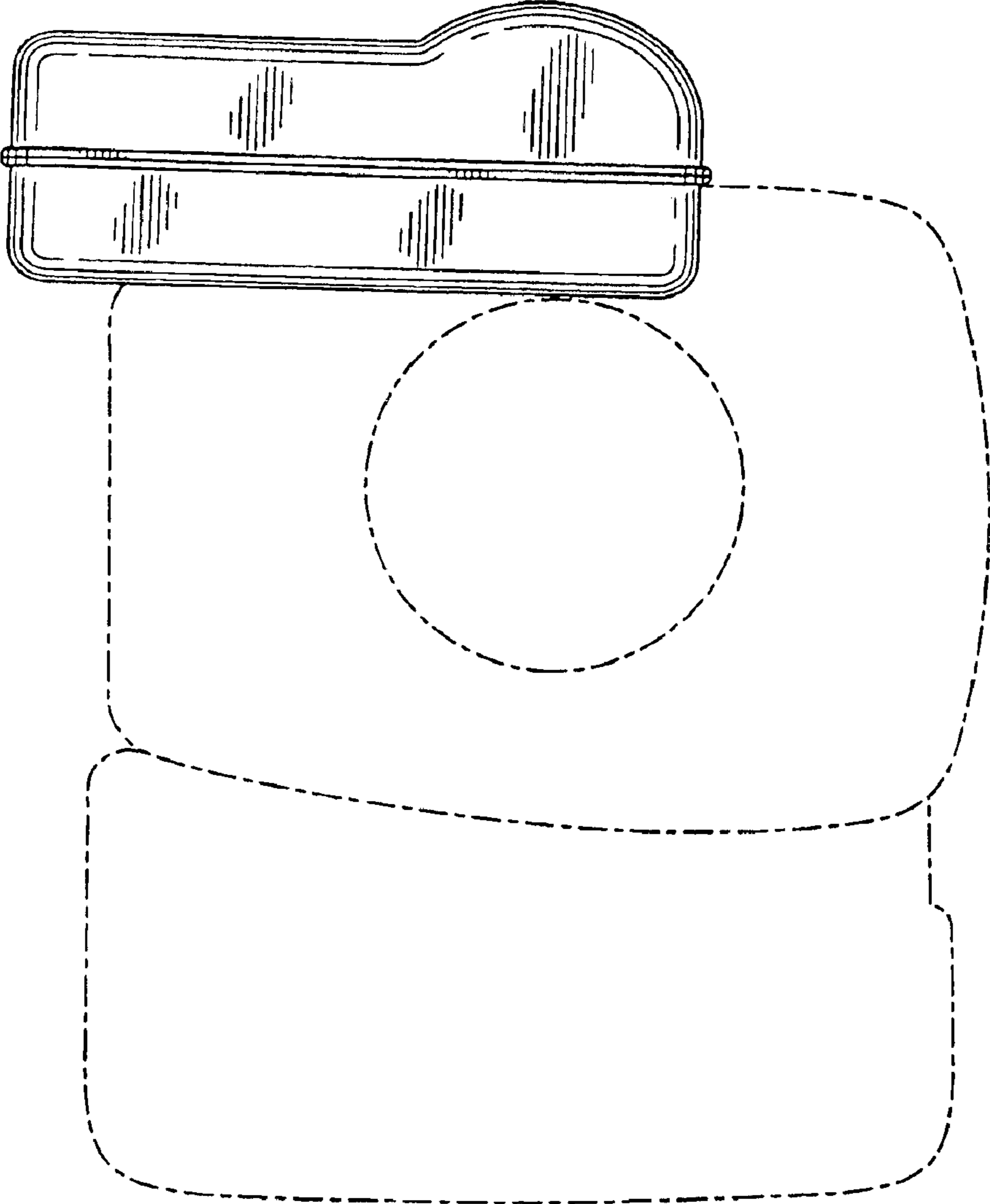

FIG. 2

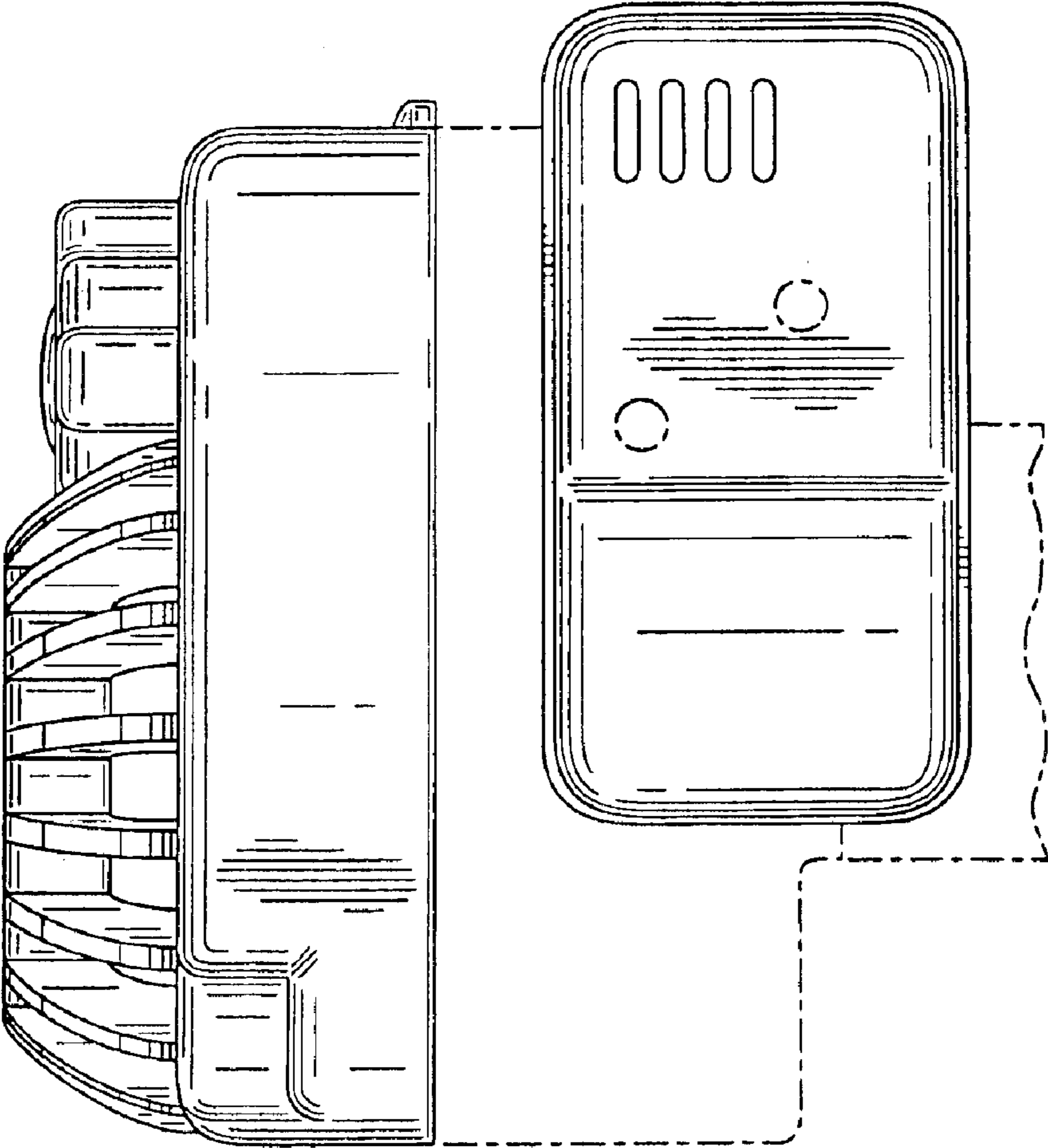

FIG. 3

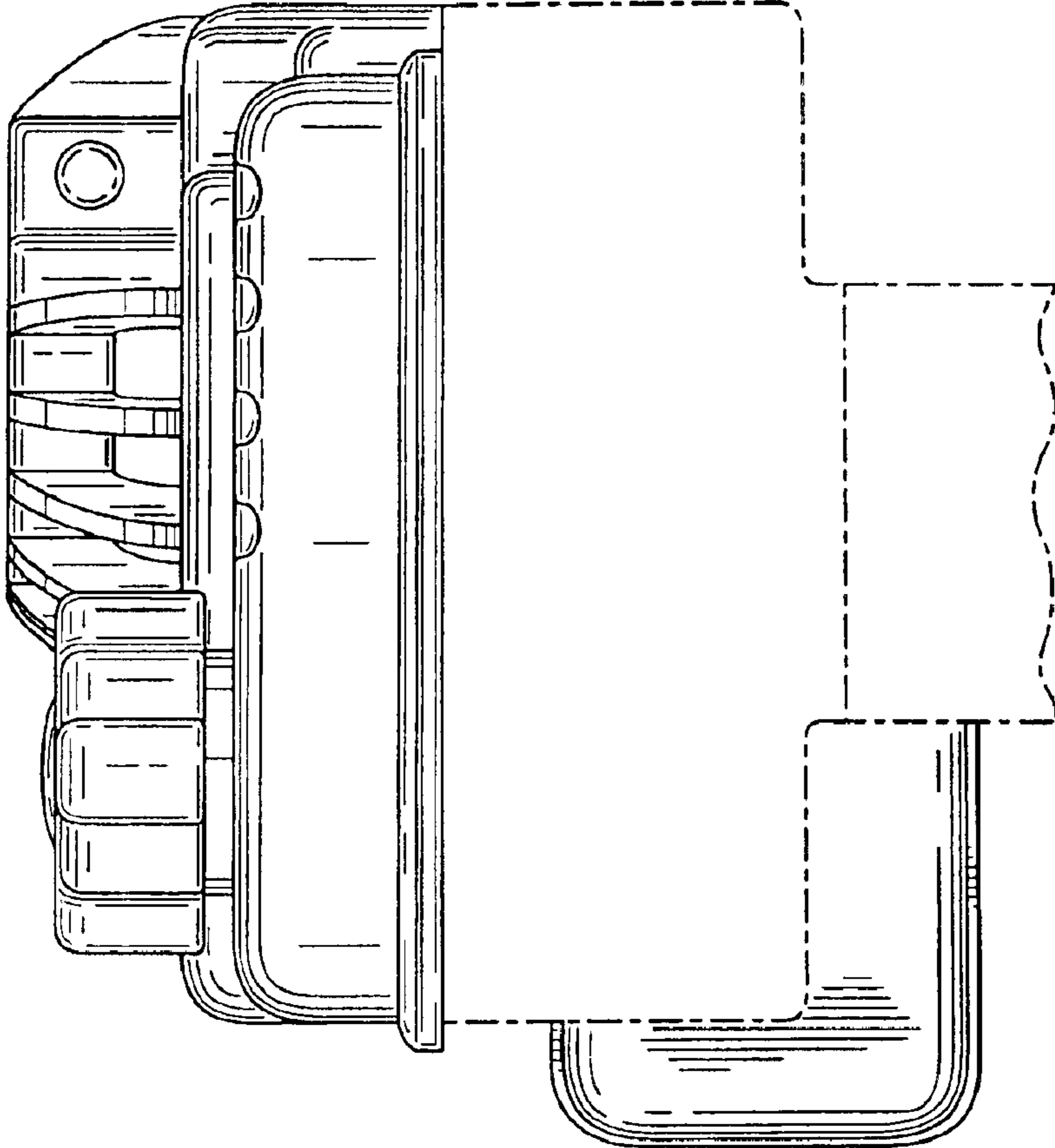

FIG. 4

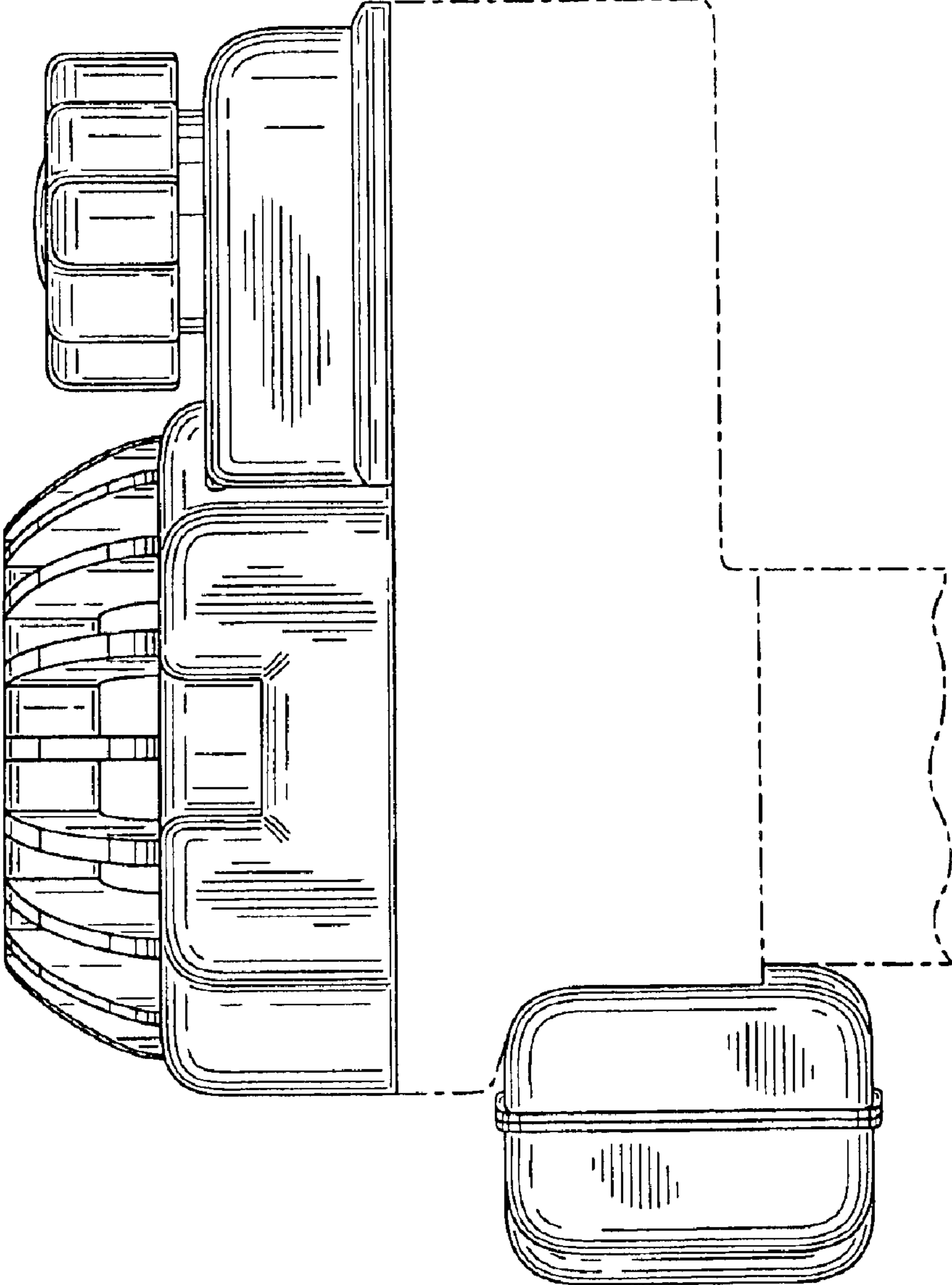

FIG. 5

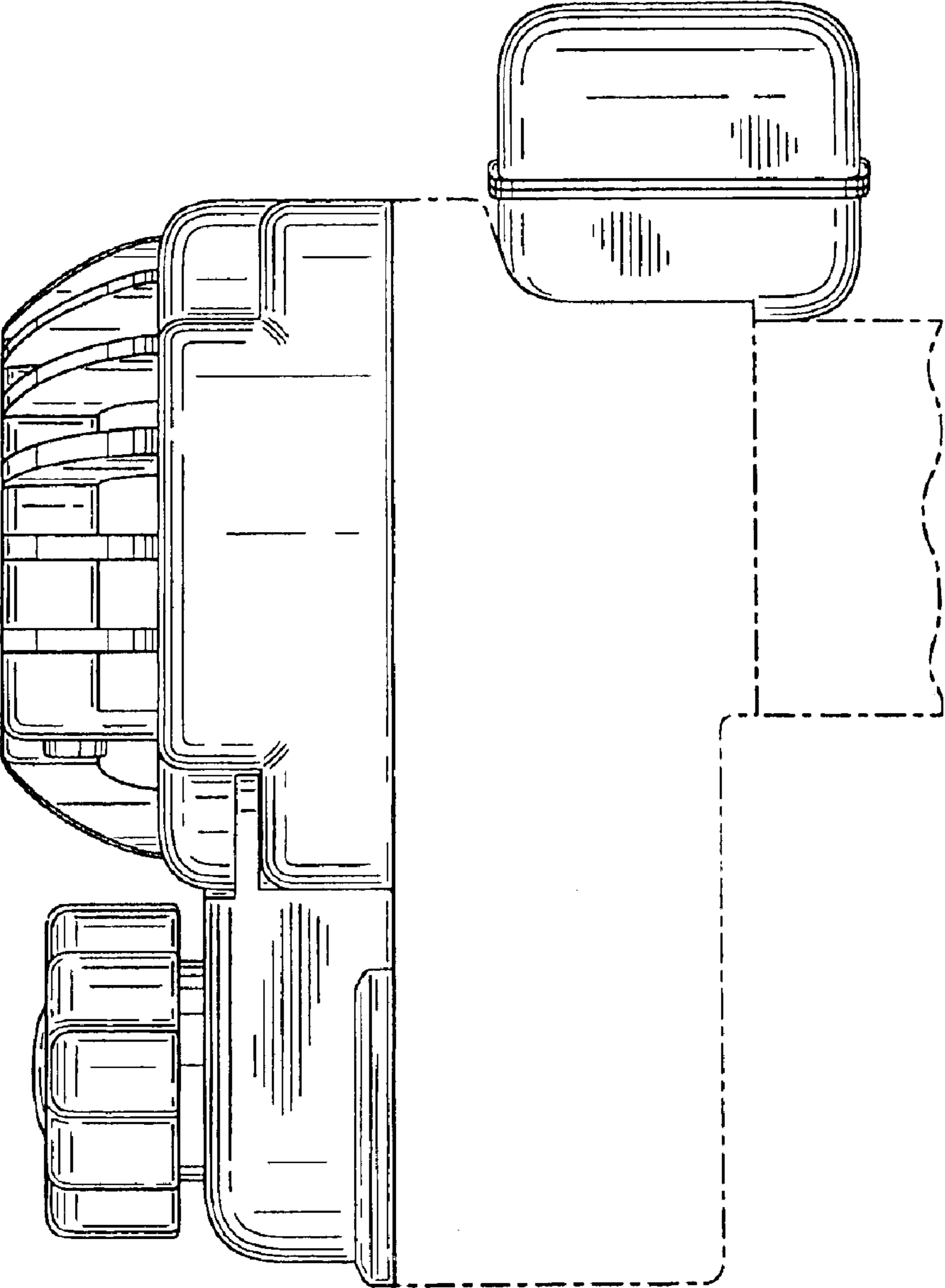

FIG. 6