

US00D503715S

(12) **United States Design Patent**
Sheehan et al.

(10) **Patent No.: US D503,715 S**

(45) **Date of Patent: ** Apr. 5, 2005**

(54) **MOUSE WITH CORD WRAP**

(75) Inventors: **Peter Sheehan**, Newcastle (IE); **Eugene Canavan**, Bray (IE)

(73) Assignee: **Logitech Europe S.A.**, Romanel-sur Morges (CH)

(**) Term: **14 Years**

(21) Appl. No.: **29/195,304**

(22) Filed: **Dec. 8, 2003**

(51) **LOC (7) Cl.** **14-02**

(52) **U.S. Cl.** **D14/402**

(58) **Field of Search** D14/402-411,
D14/454, 432-434, 240; 345/156-167;
74/471 XY; 273/148 B; 200/5 R, 5 A, 6 R,
6 A

(56) **References Cited**

U.S. PATENT DOCUMENTS

- D431,567 S * 10/2000 You D14/408
- D436,962 S * 1/2001 Varga et al. D14/402
- D472,899 S * 4/2003 Hu et al. D14/402
- D474,769 S * 5/2003 Fisher et al. D14/408

D479,528 S * 9/2003 Sheehan et al. D14/408

* cited by examiner

Primary Examiner—Pamela Burgess

(74) *Attorney, Agent, or Firm*—Townsend and Townsend and Crew LLP

(57) **CLAIM**

The ornamental design for mouse with cord wrap, as shown and described.

DESCRIPTION

FIG. 1 is a perspective view of a mouse with cord wrap showing our new design with the cord wrapped in position; FIG. 2 is a perspective view thereof, showing the cord unwrapped and broken away to indicate indeterminate length;

FIG. 3 is a top plan view thereof;

FIG. 4 is a left side elevational view, the right side elevational view being a mirror image thereof;

FIG. 5 is a bottom plan view thereof.

FIG. 6 is a front elevational view thereof; and,

FIG. 7 is a rear elevational view thereof.

The broken lines shown in FIGS. 1, 2, 3, 4 and 6 are for illustrative purposes only and form no part of the claimed design.

1 Claim, 3 Drawing Sheets

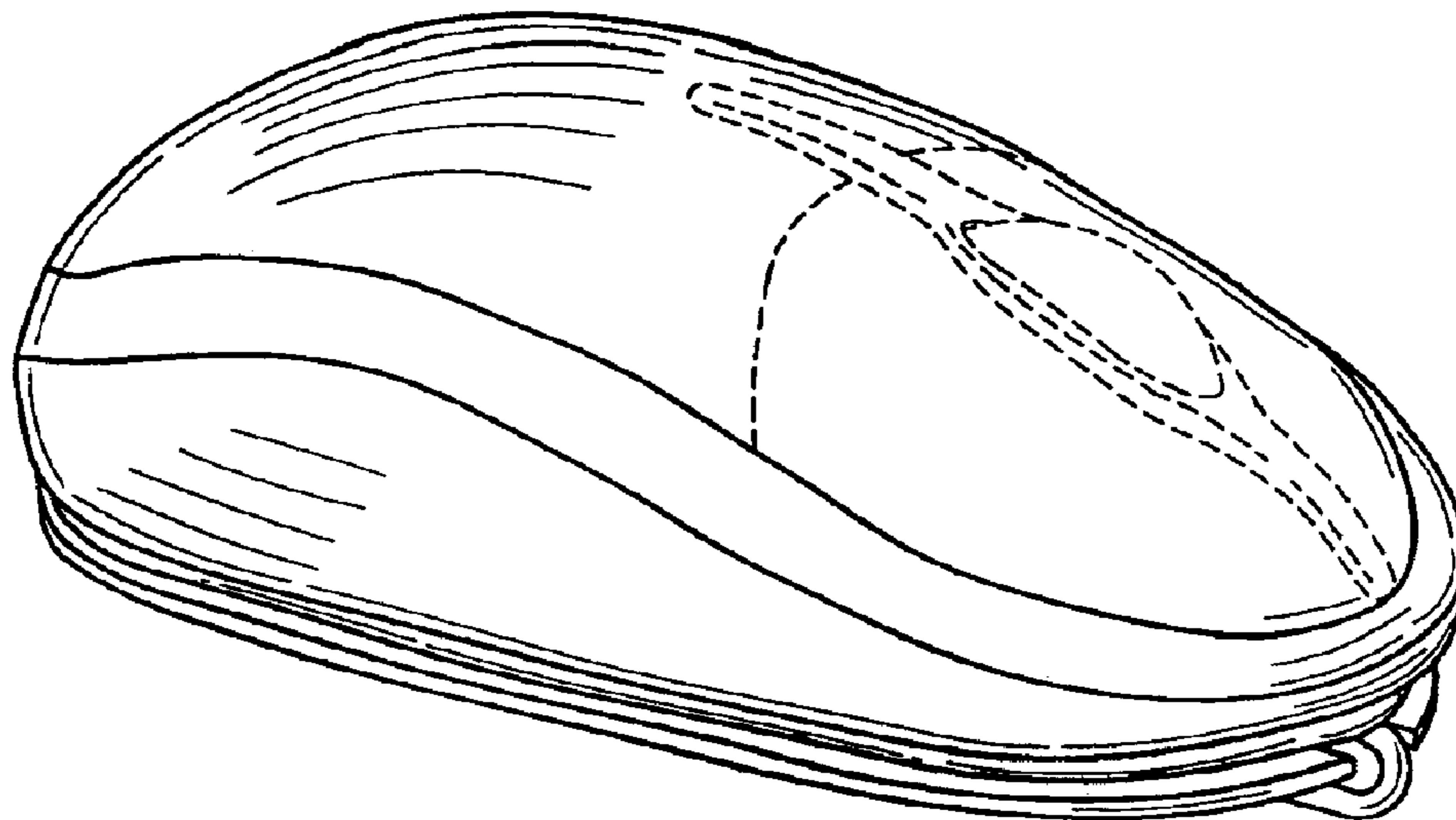

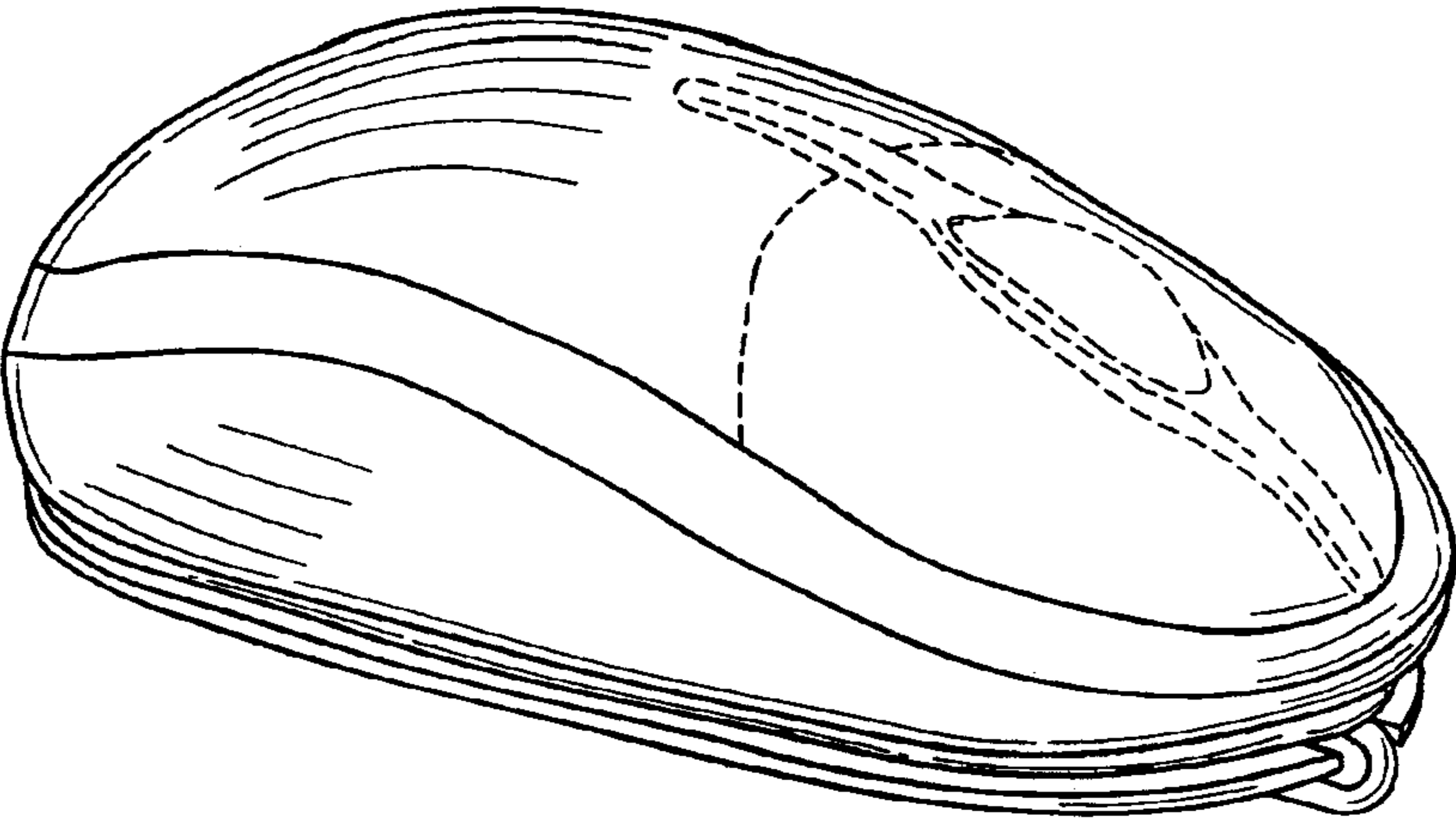

FIG. 1

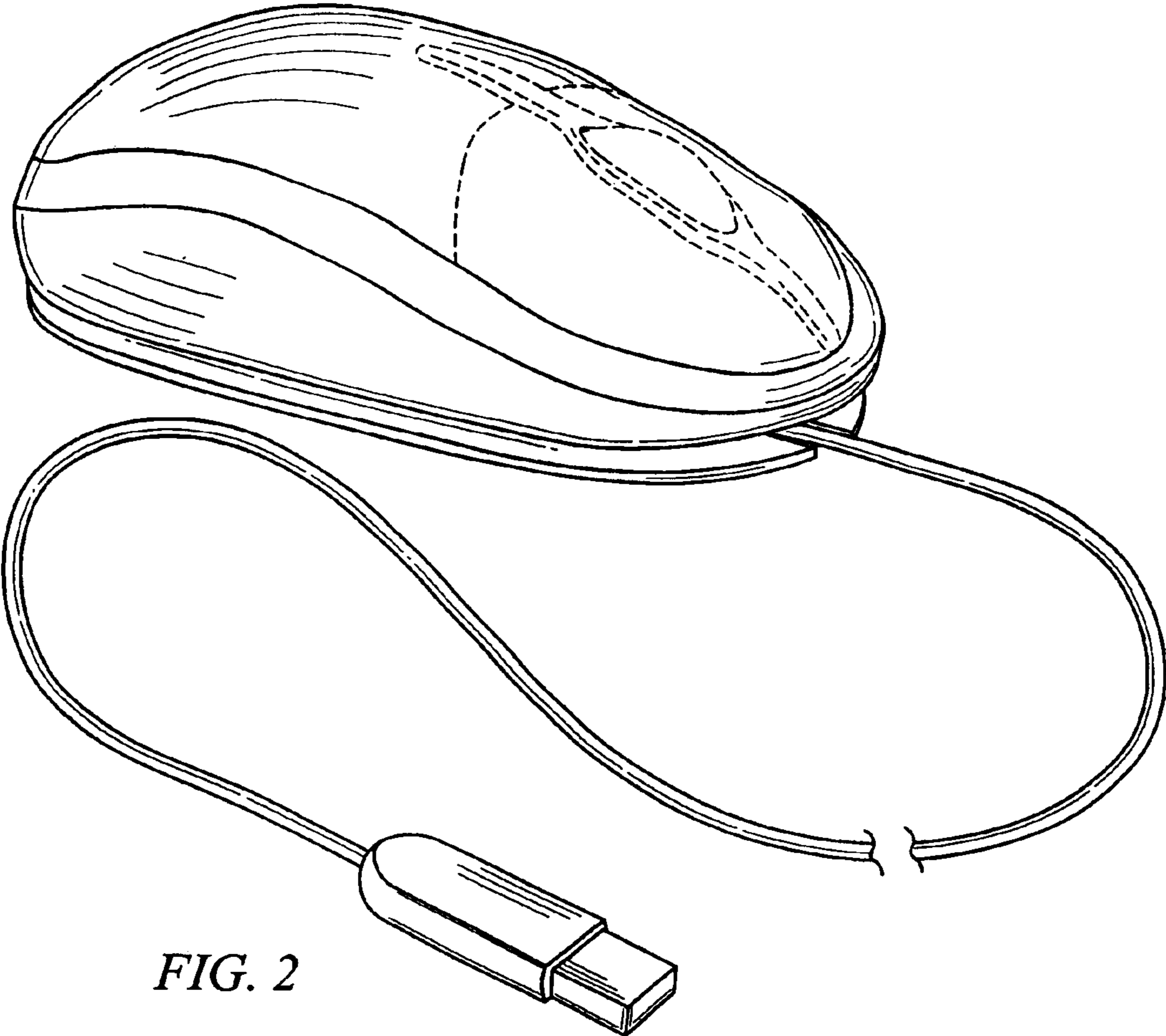

FIG. 2

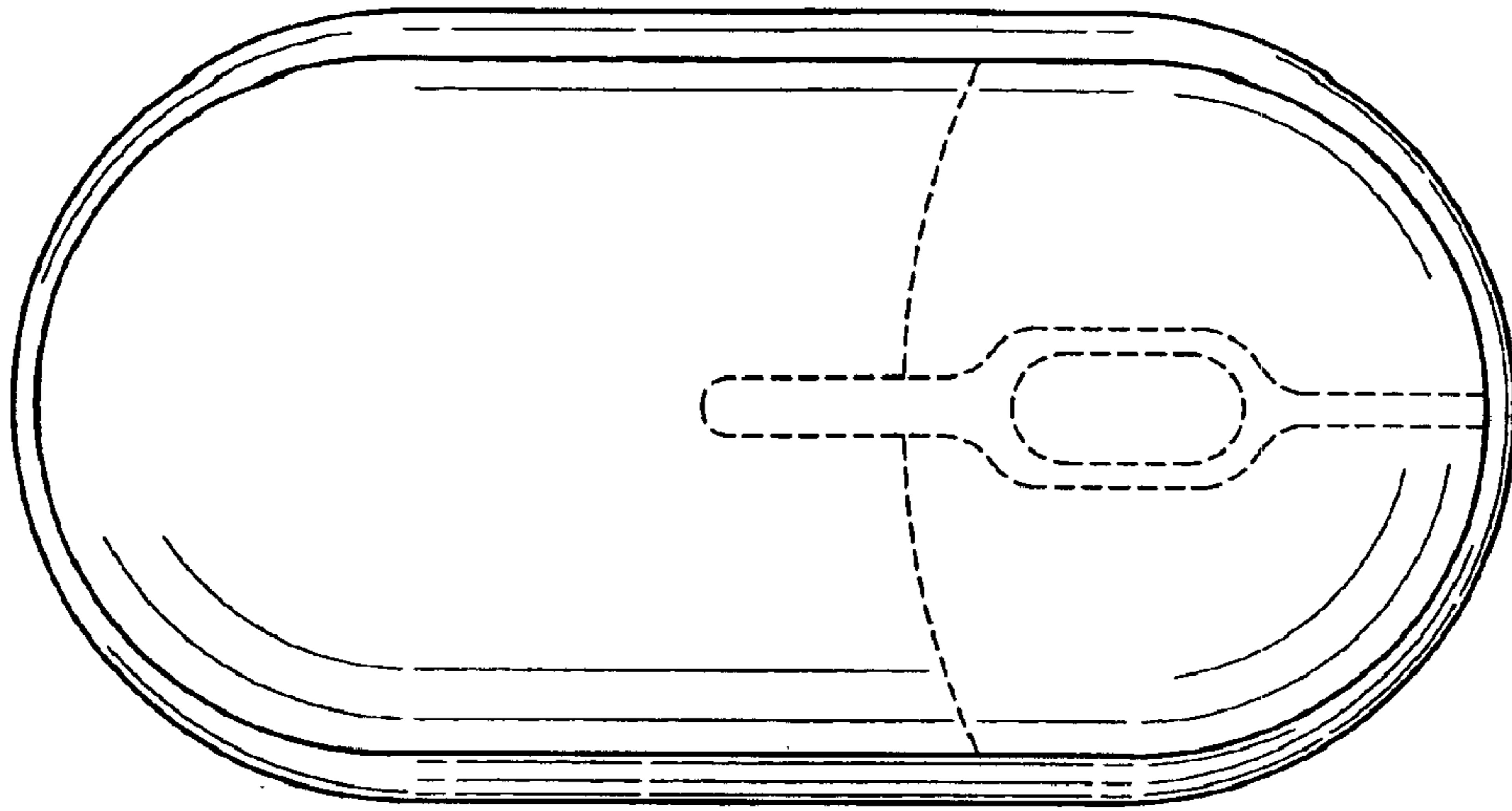

FIG. 3

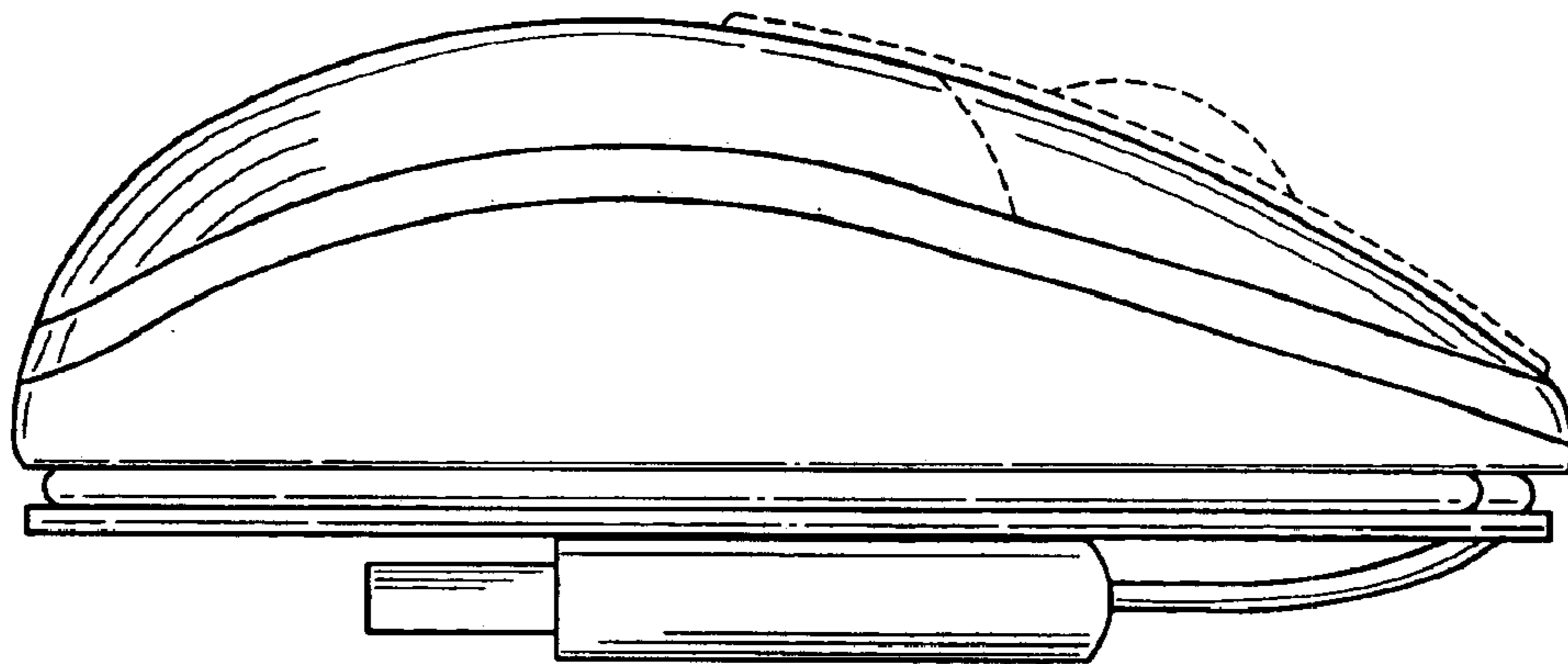

FIG. 4

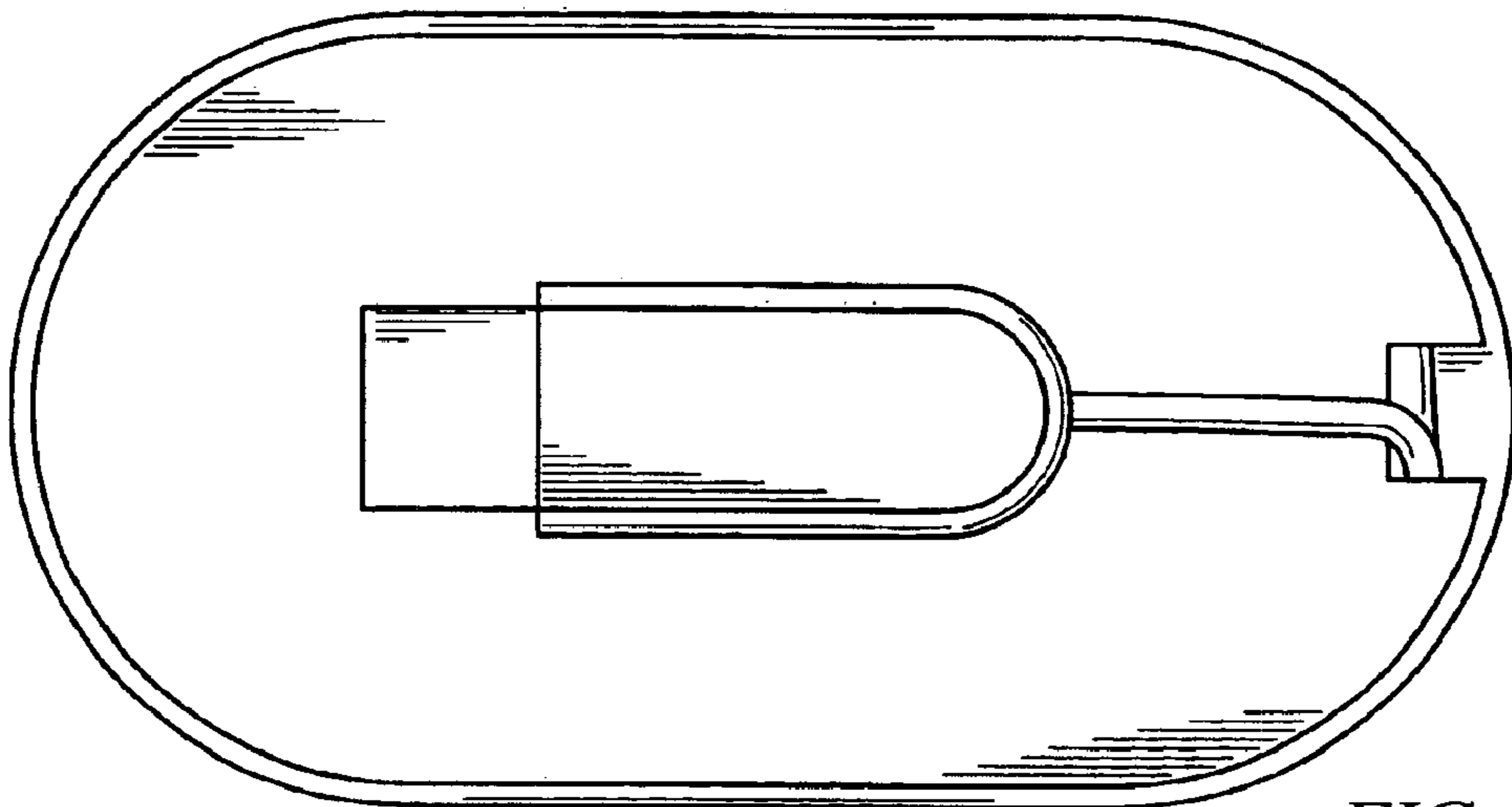

FIG. 5

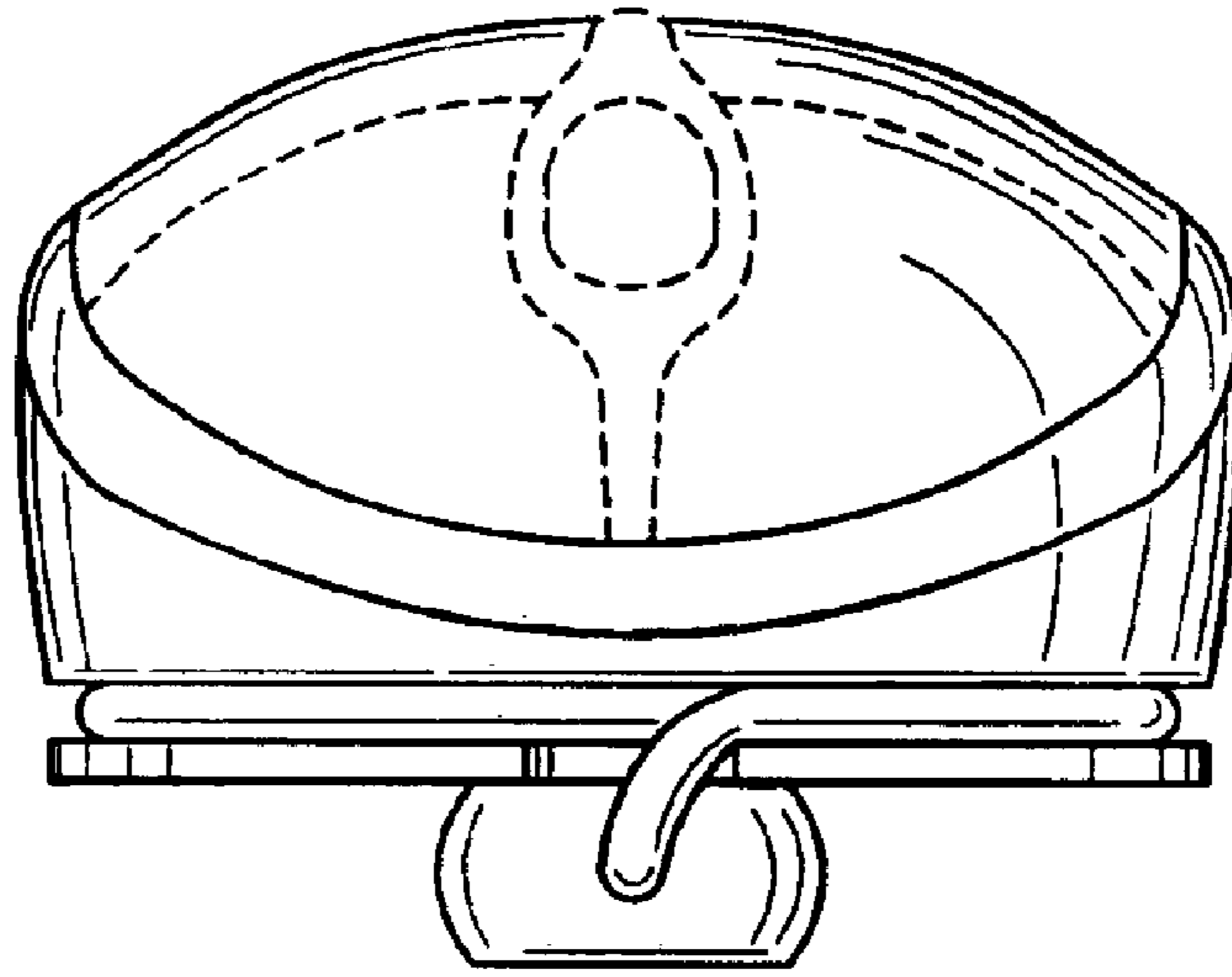

FIG. 6

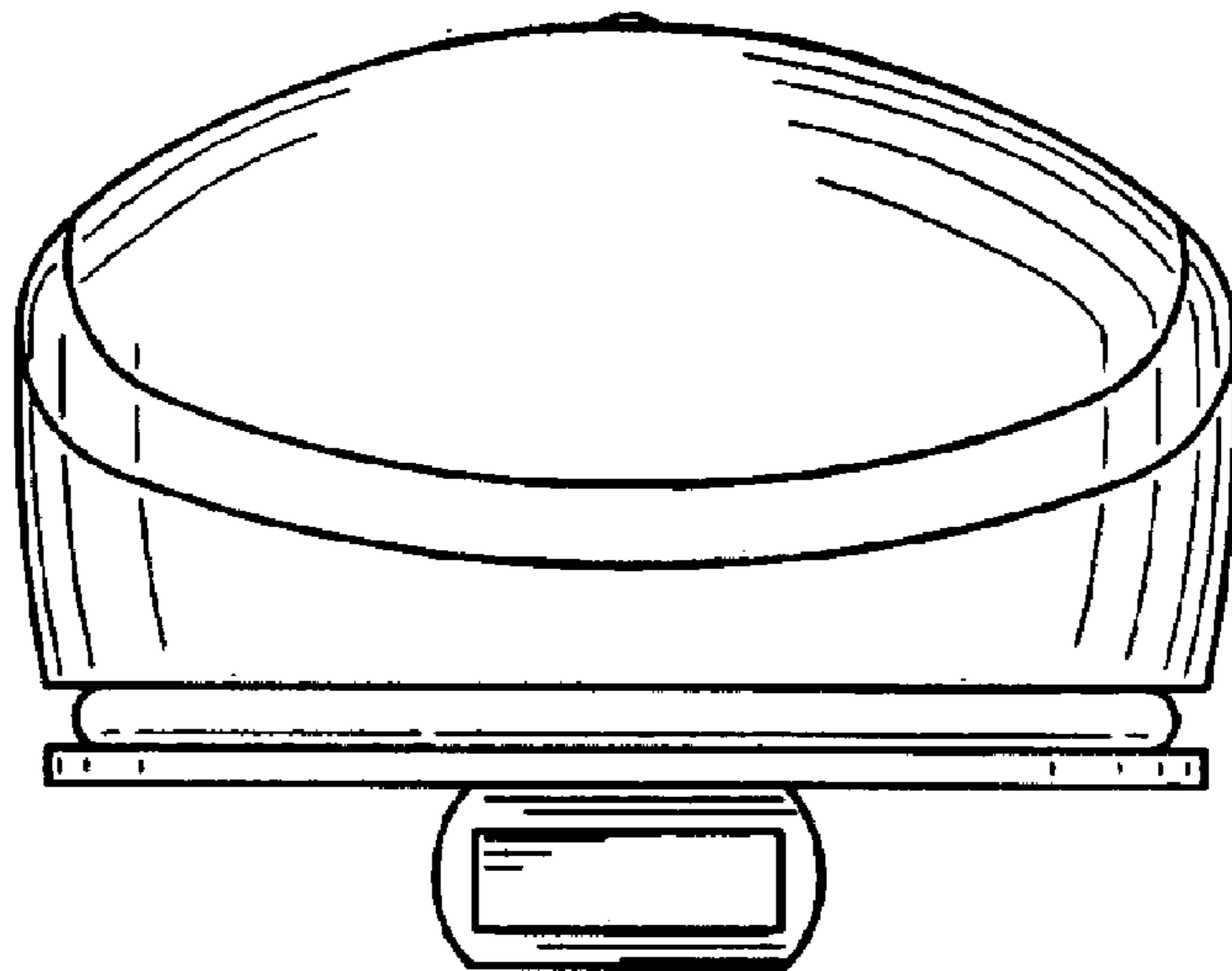

FIG. 7