

US00D503615S

(12) **United States Design Patent**  
**Gratiot**

(10) **Patent No.:** **US D503,615 S**

(45) **Date of Patent:** **\*\* Apr. 5, 2005**

(54) **SUPPORT FOR HOLDING WATCHES**

(75) **Inventor:** **Daniel Gratiot, Berne (CH)**

(73) **Assignee:** **Swatch AG, Bienne (CH)**

(\*\*) **Term:** **14 Years**

(21) **Appl. No.:** **29/189,815**

(22) **Filed:** **Sep. 11, 2003**

(30) **Foreign Application Priority Data**

Mar. 11, 2003 (WO) ..... DM/063 367

(51) **LOC (7) Cl.** ..... **09-07**

(52) **U.S. Cl.** ..... **D9/422**

(58) **Field of Search** ..... D9/422, 415, 455,  
D9/434, 414; 206/301, 6.1, 566, 756, 730-735,  
762, 764; 20/4.21, 4.24, 252

(56) **References Cited**

**U.S. PATENT DOCUMENTS**

3,217,867 A \* 11/1965 Harris ..... 206/468  
3,530,978 A \* 9/1970 Lewandowski ..... 206/468  
3,696,935 A \* 10/1972 Dean ..... 211/41.12

D234,775 S \* 4/1975 Blackburn et al. .... D14/483  
D340,643 S \* 10/1993 Hirsch ..... D9/418  
5,358,134 A \* 10/1994 Ripley et al. .... 220/787  
D355,359 S \* 2/1995 Herzog ..... D9/422  
5,547,076 A \* 8/1996 Doi et al. .... 206/301  
D431,777 S \* 10/2000 Marciano ..... D9/422

\* cited by examiner

*Primary Examiner*—Prabhakar Deshmukh

(74) *Attorney, Agent, or Firm*—Collen IP; Donald J. Ranft

(57) **CLAIM**

The ornamental design for a support for holding watches, as shown and described.

**DESCRIPTION**

FIG. 1 is a front view of my new and ornamental design for a support for holding watches;  
FIG. 2 is a rear view thereof;  
FIG. 3 is a left side view thereof;  
FIG. 4 is a right side view thereof;  
FIG. 5 is a top view thereof;  
FIG. 6 is a bottom view thereof; and,  
FIG. 7 is a perspective view thereof.

**1 Claim, 7 Drawing Sheets**

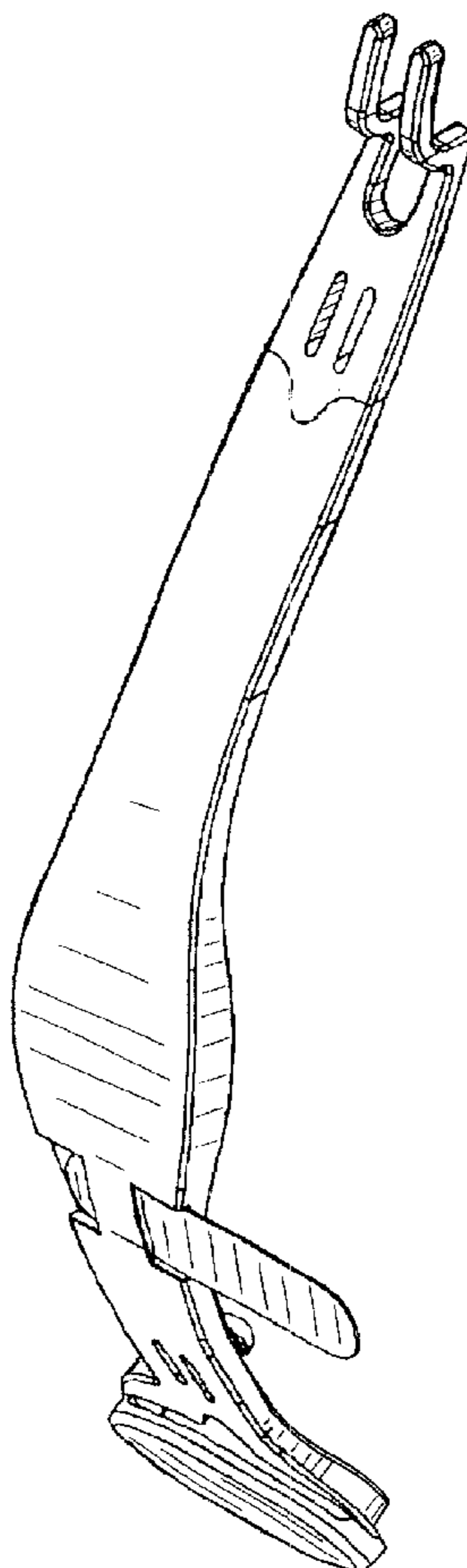

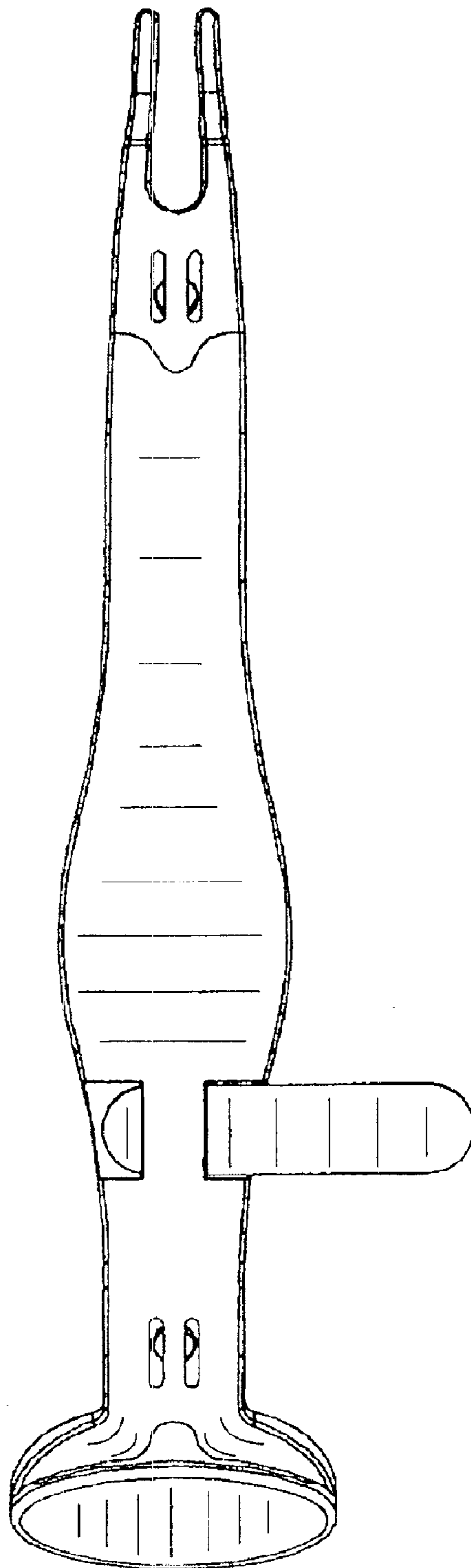

Figure 1

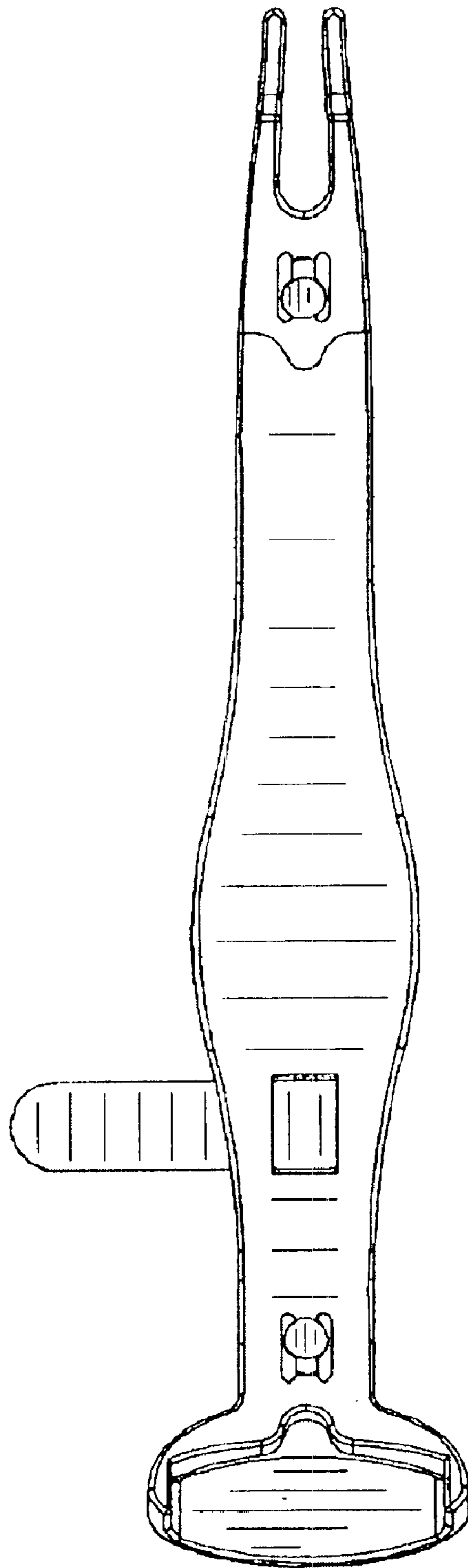

Figure 2

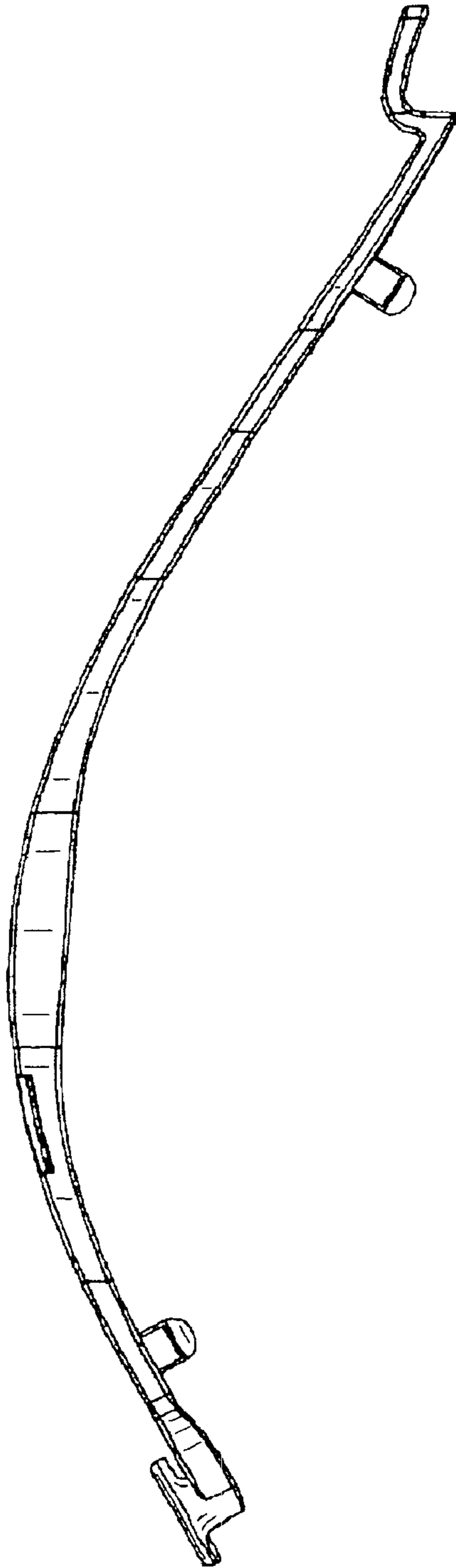

Figure 3

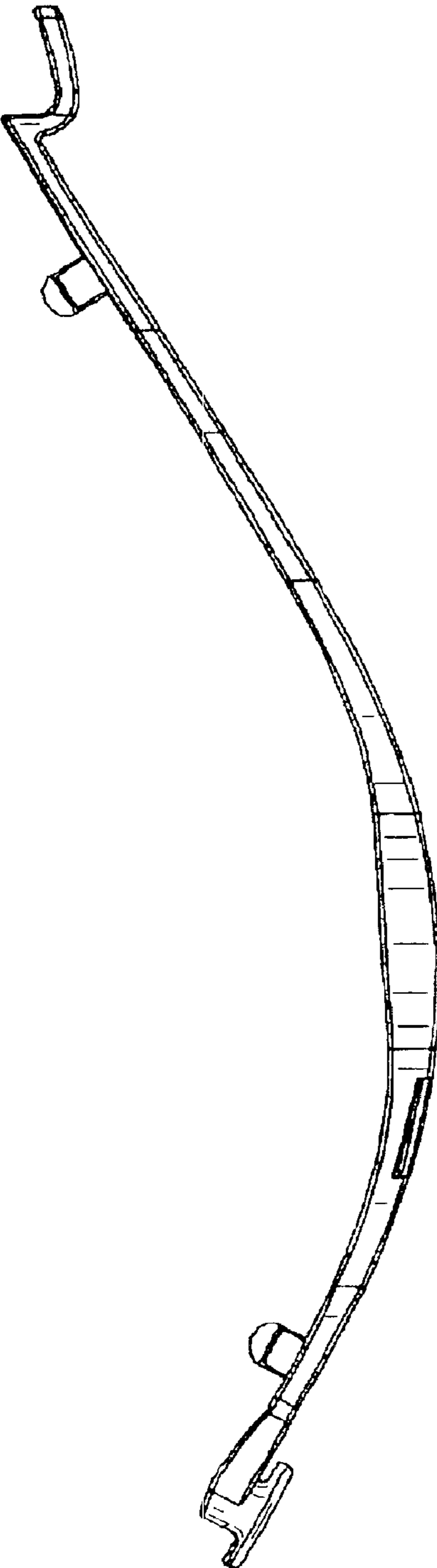

Figure 4

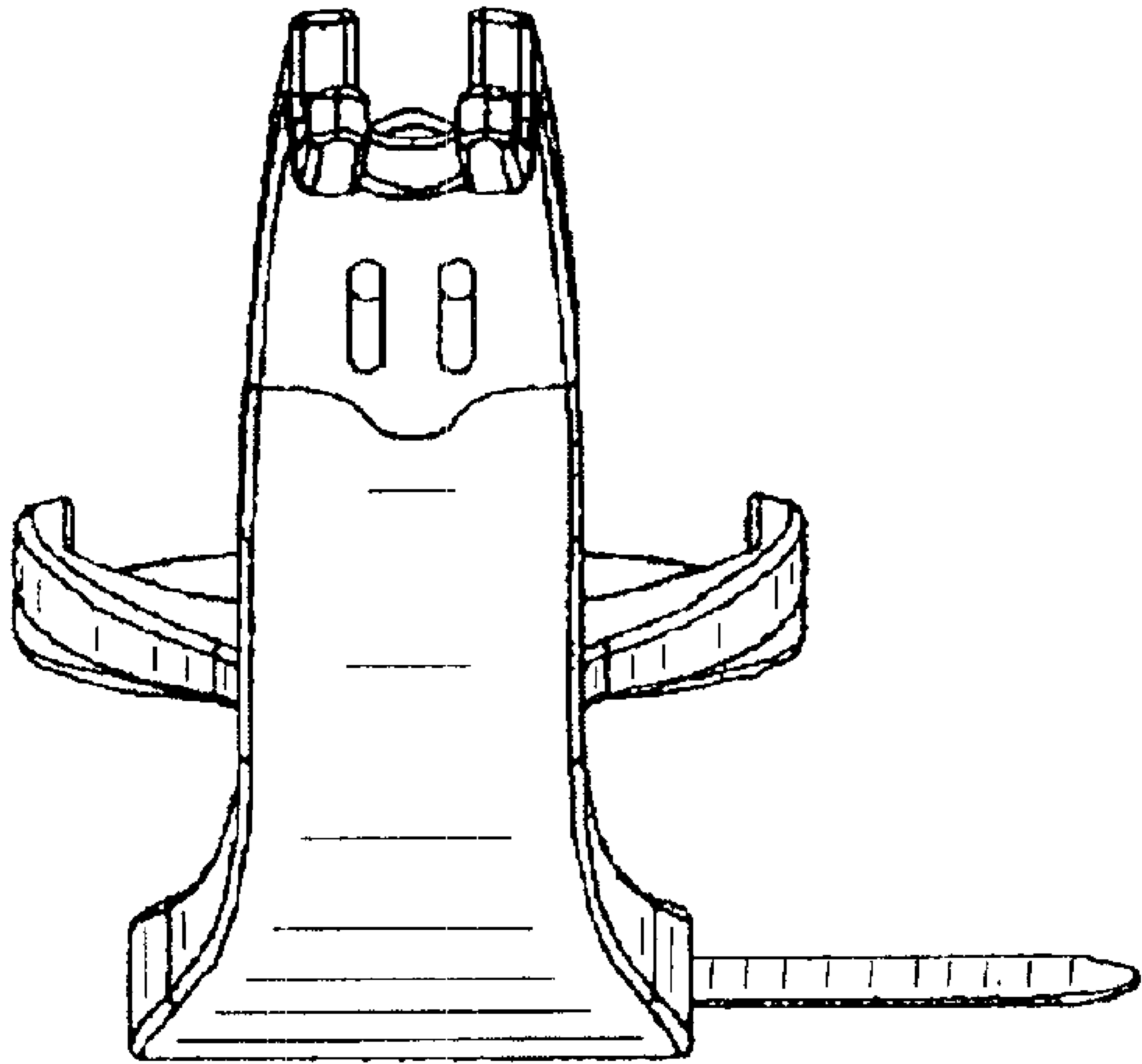

Figure 5

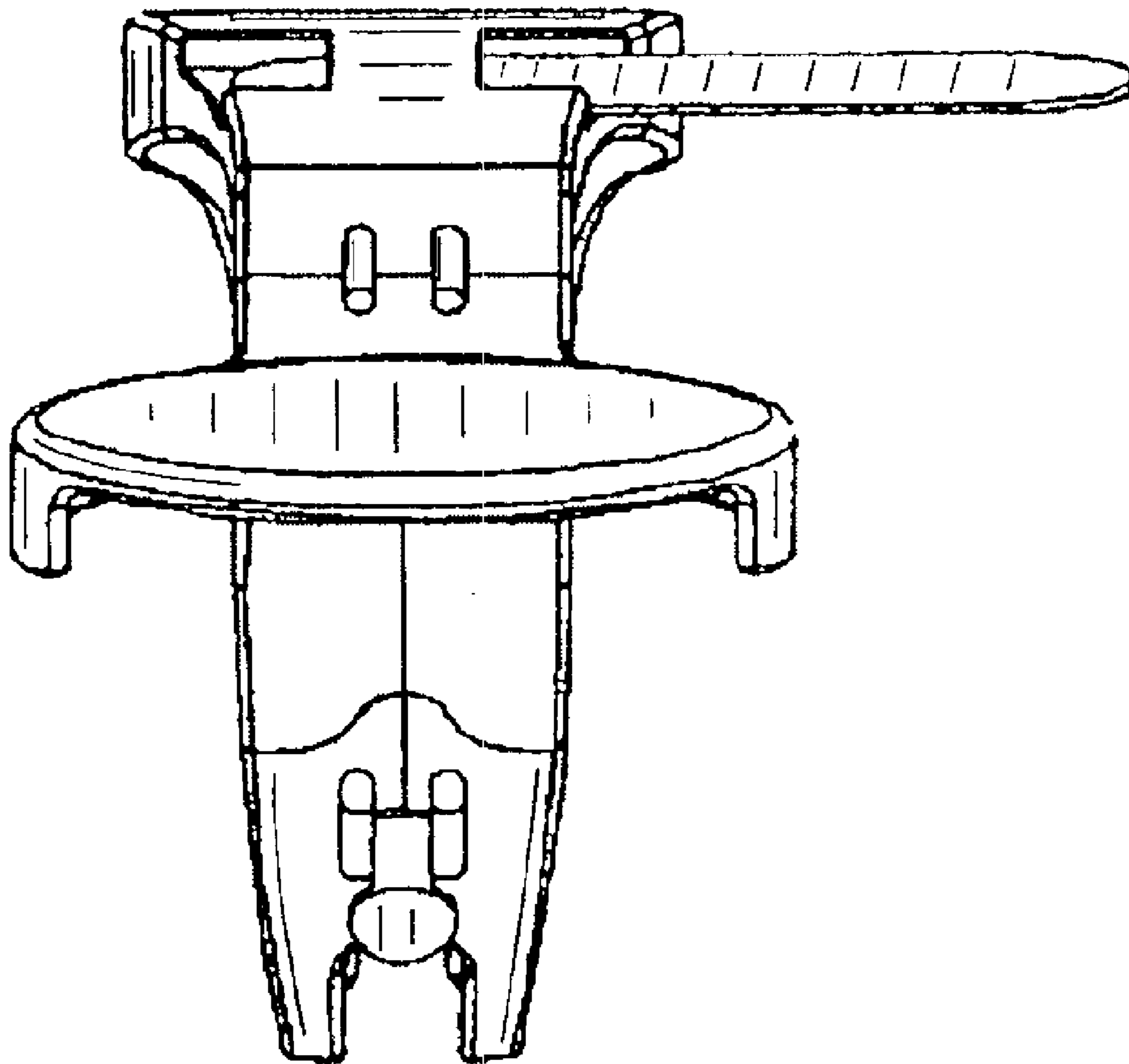

Figure 6

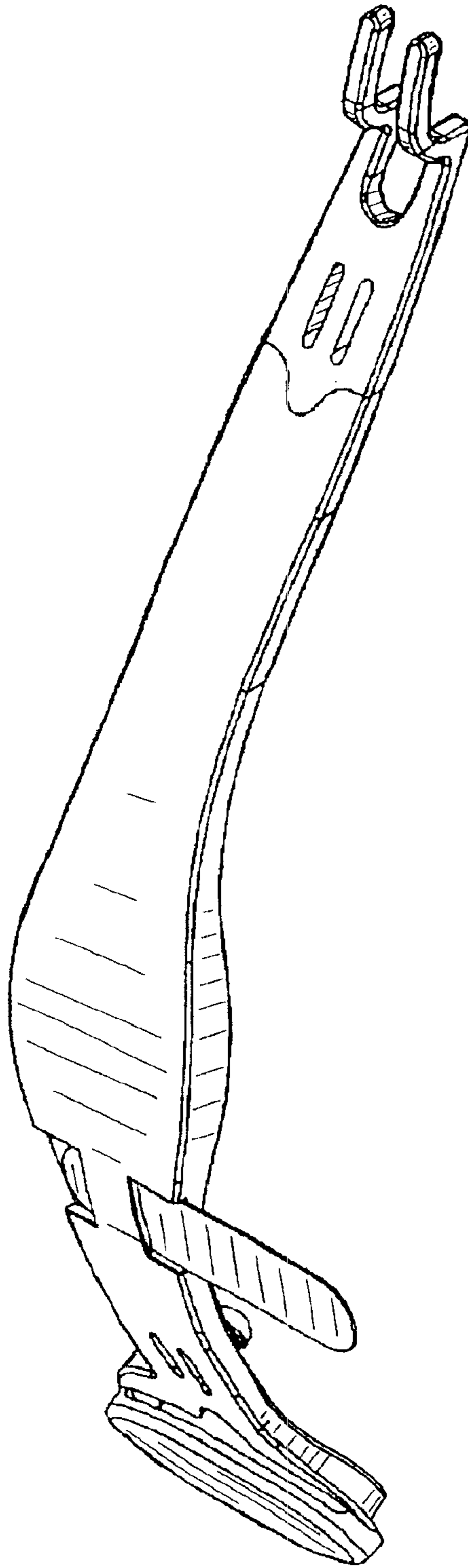

Figure 7