

US00D503461S

(12) **United States Design Patent**  
**Ouyoung**

(10) **Patent No.: US D503,461 S**

(45) **Date of Patent: \*\* Mar. 29, 2005**

(54) **SHOWER HEAD**

D325,770 S \* 4/1992 Haug et al. .... D23/213

(75) Inventor: **Scott Ouyoung**, Taichung (TW)

\* cited by examiner

(73) Assignee: **Globe Union Industrial Corp.**,  
Taichung (TW)

*Primary Examiner*—Robin V. Taylor

(74) *Attorney, Agent, or Firm*—Troxell Law Office PLLC

(\*\*) Term: **14 Years**

(57) **CLAIM**

The ornamental design for a shower head, as show and described.

(21) Appl. No.: **29/195,461**

(22) Filed: **Dec. 12, 2003**

**DESCRIPTION**

(51) **LOC (7) Cl.** ..... **23-01**

FIG. 1 is a top, left, front, perspective view of a shower head showing my new design;

(52) **U.S. Cl.** ..... **D23/229**

FIG. 2 is a front elevational view thereof;

(58) **Field of Search** ..... D23/213, 229,  
D23/230, 223; 239/282, 283, 394

FIG. 3 is a rear elevational view thereof;

FIG. 4 is a left elevational view thereof;

FIG. 5 is a right elevational view thereof;

FIG. 6 is a top plan view thereof; and,

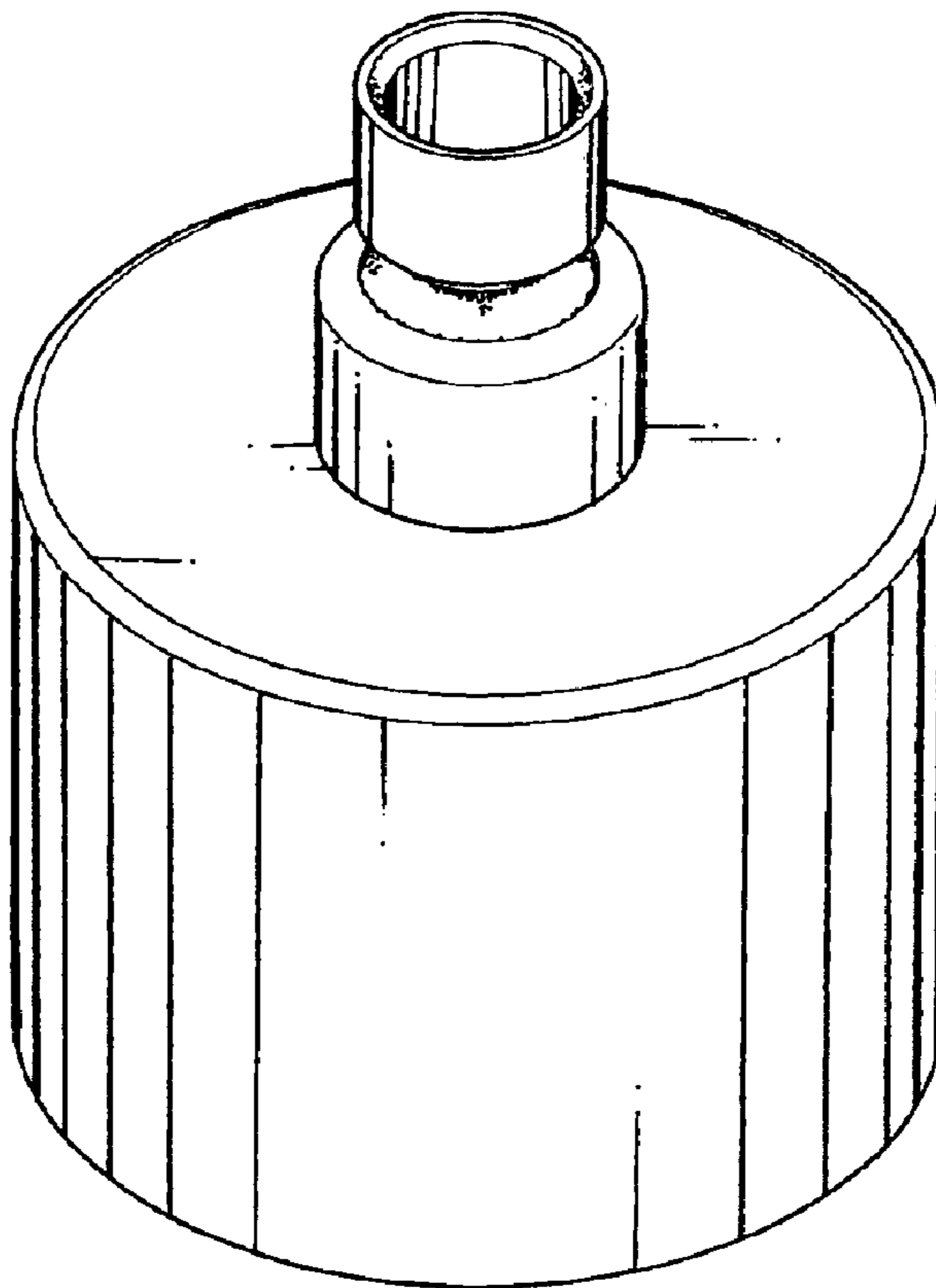
FIG. 7 is a bottom plan view thereof.

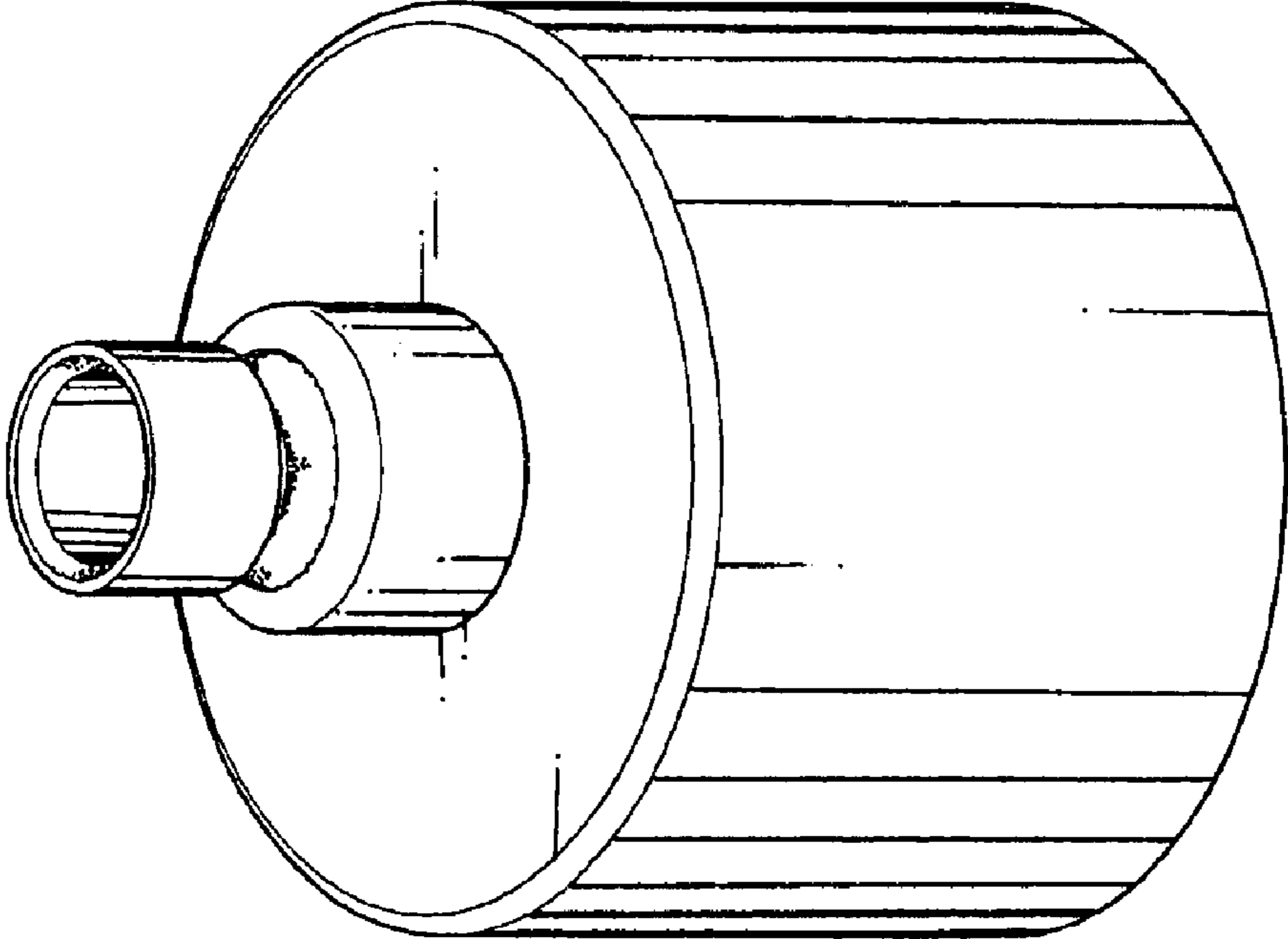
(56) **References Cited**

**U.S. PATENT DOCUMENTS**

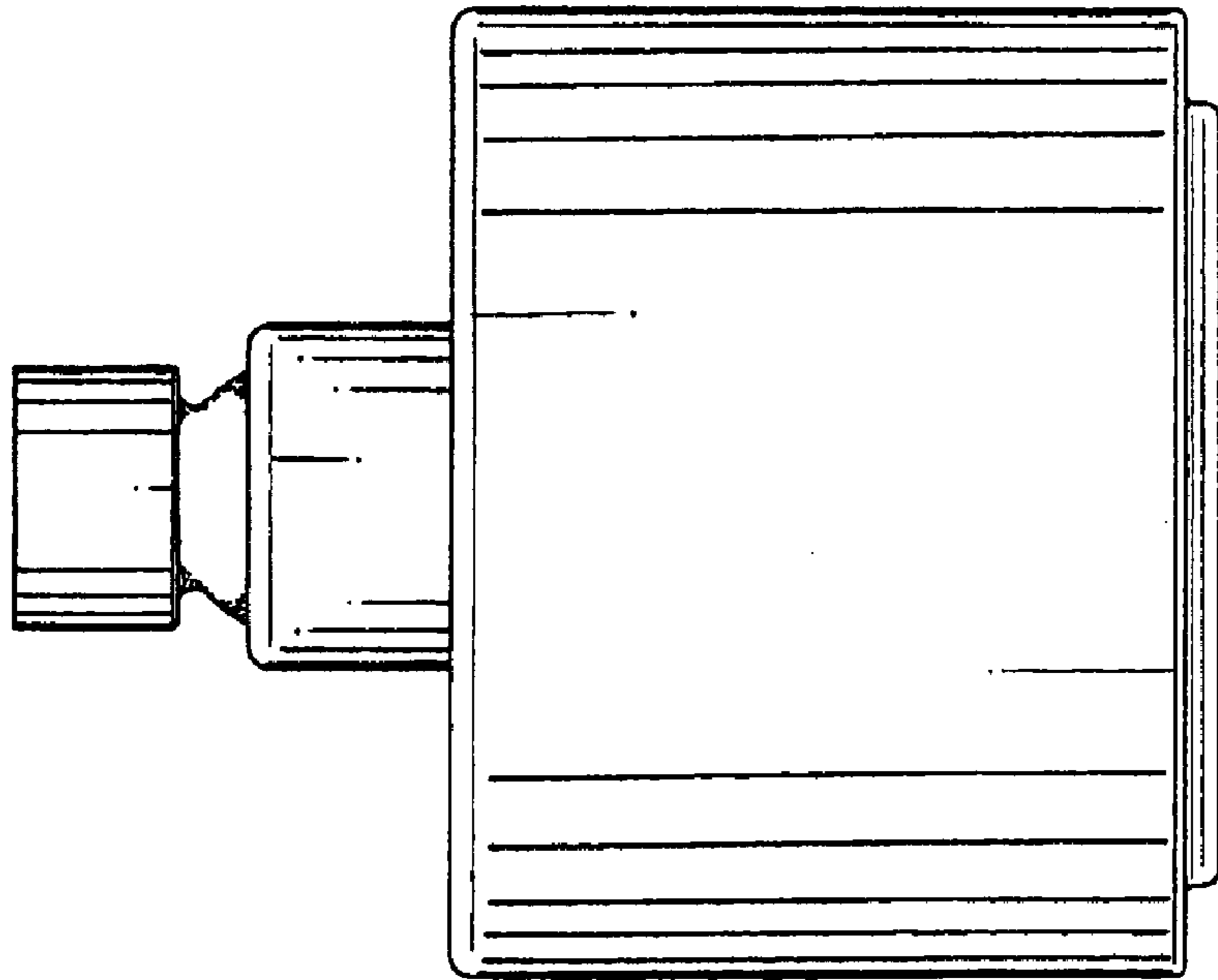
D261,417 S \* 10/1981 Klose ..... D23/229

**1 Claim, 4 Drawing Sheets**

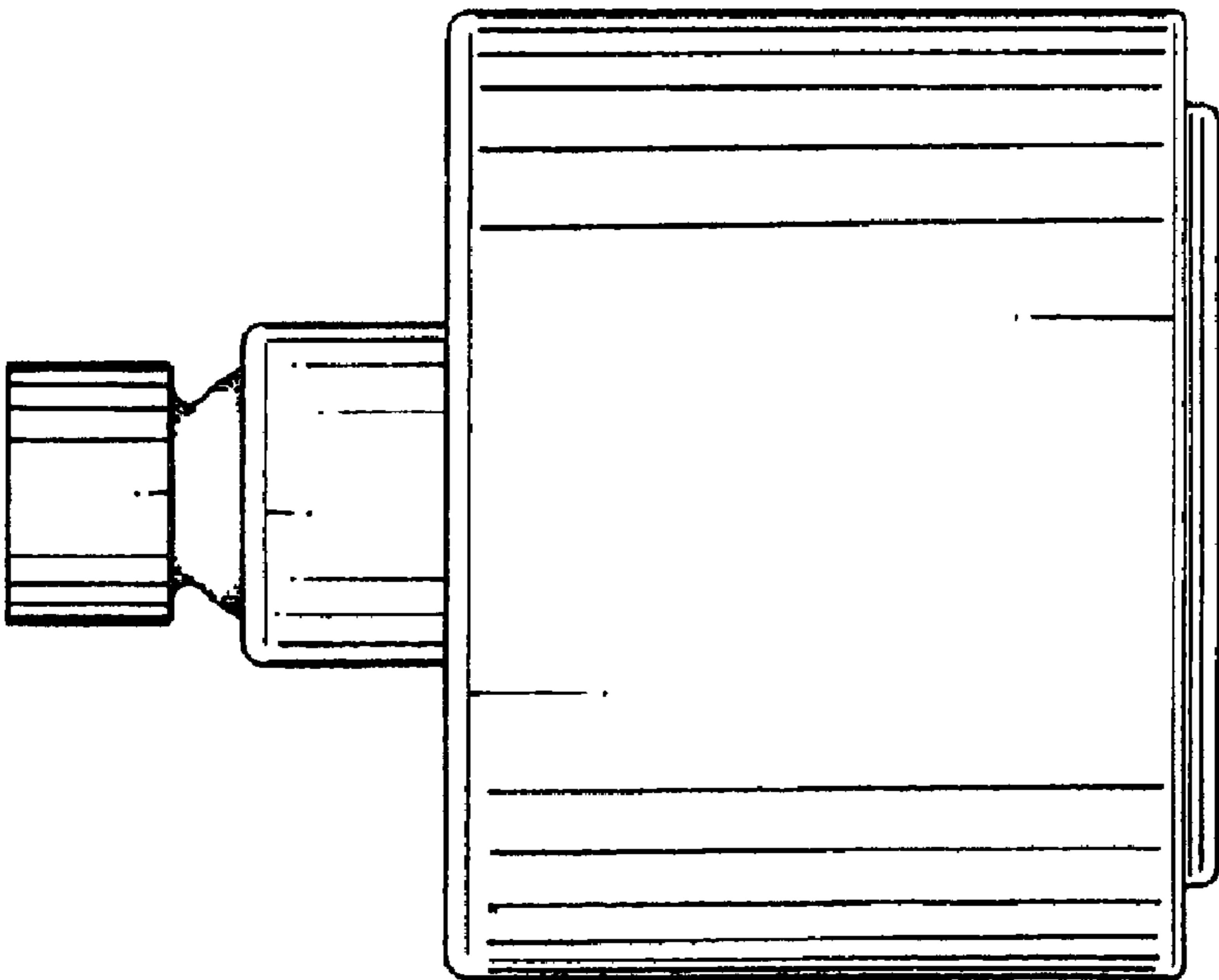




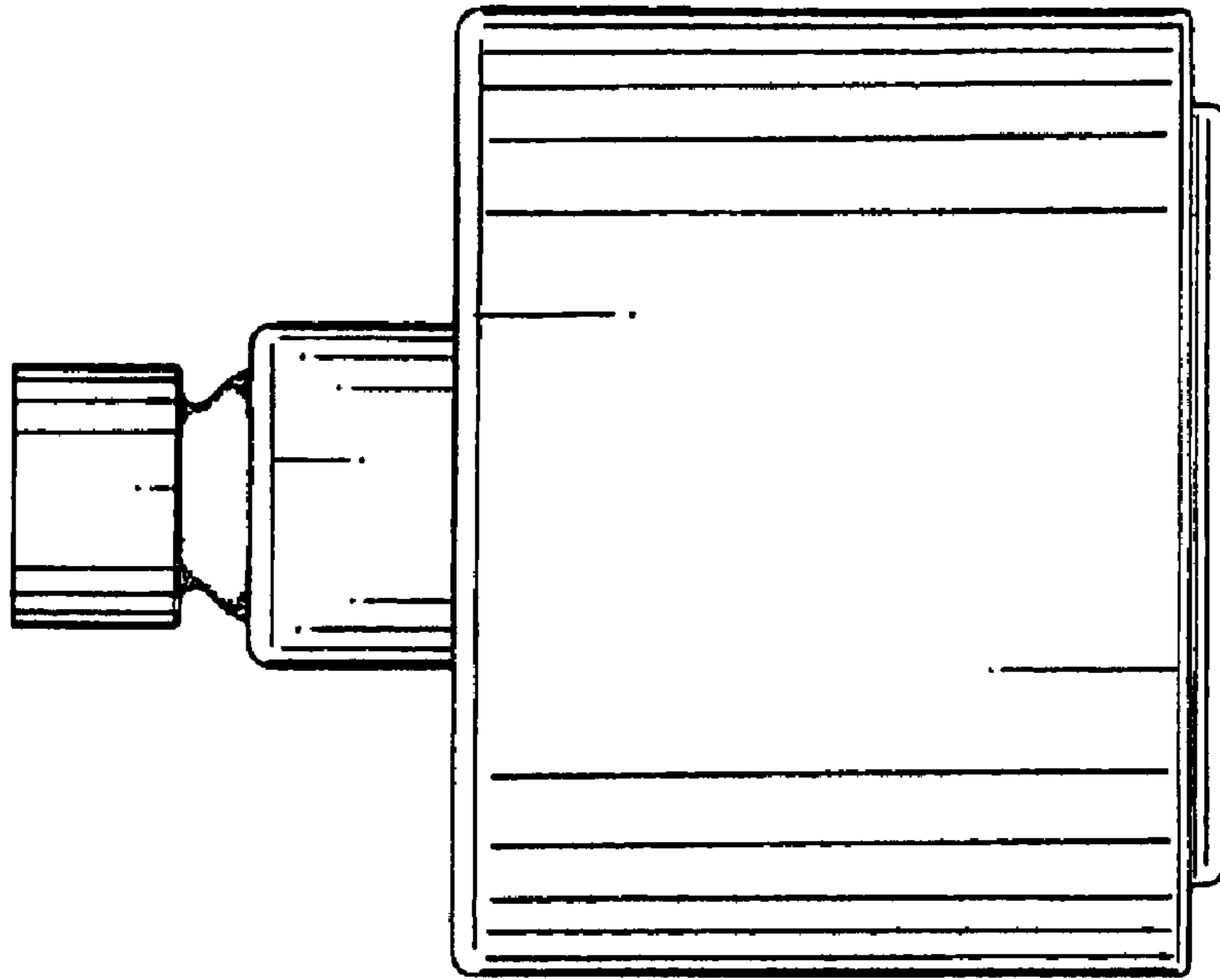
**FIG. 1**



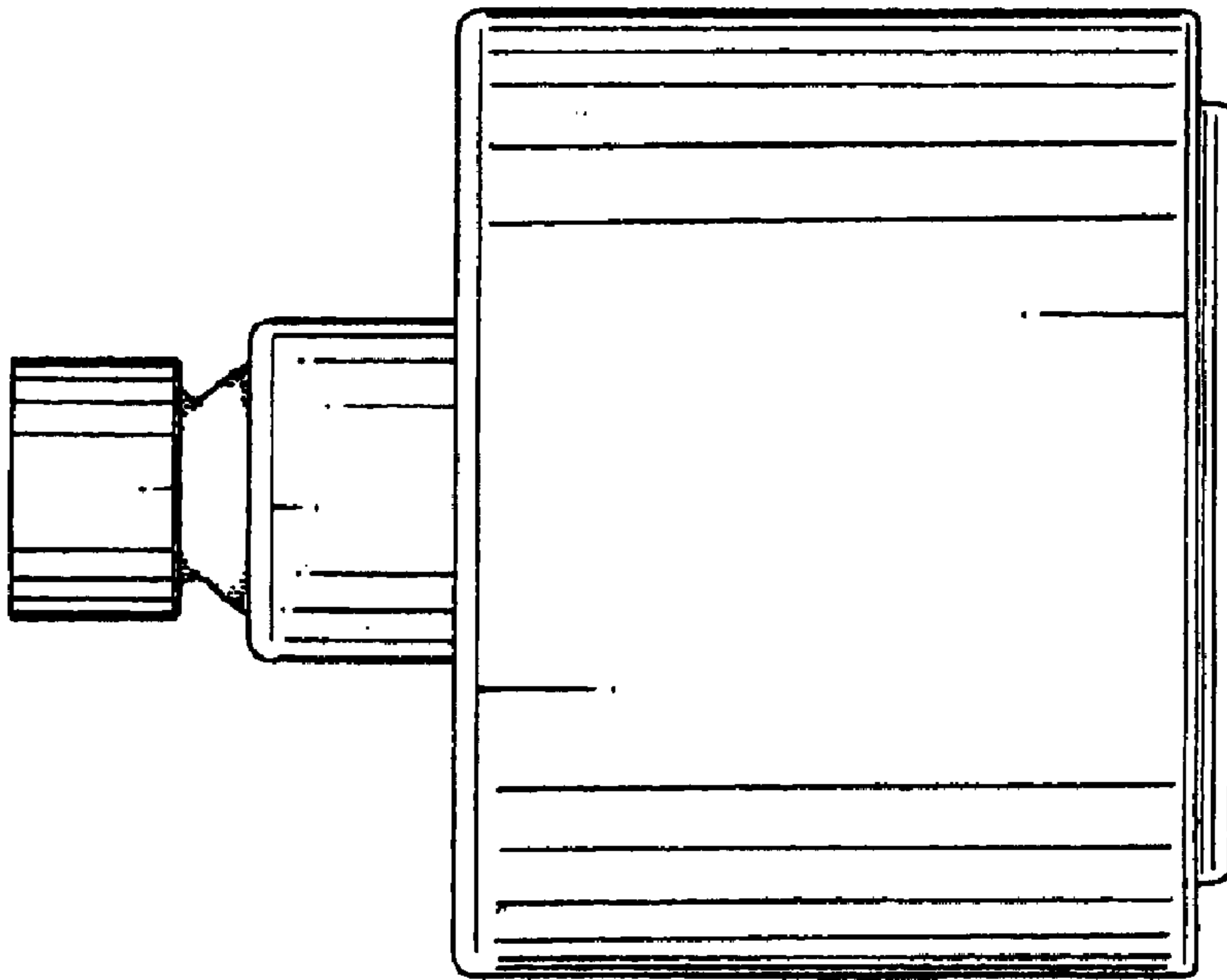
**FIG. 2**



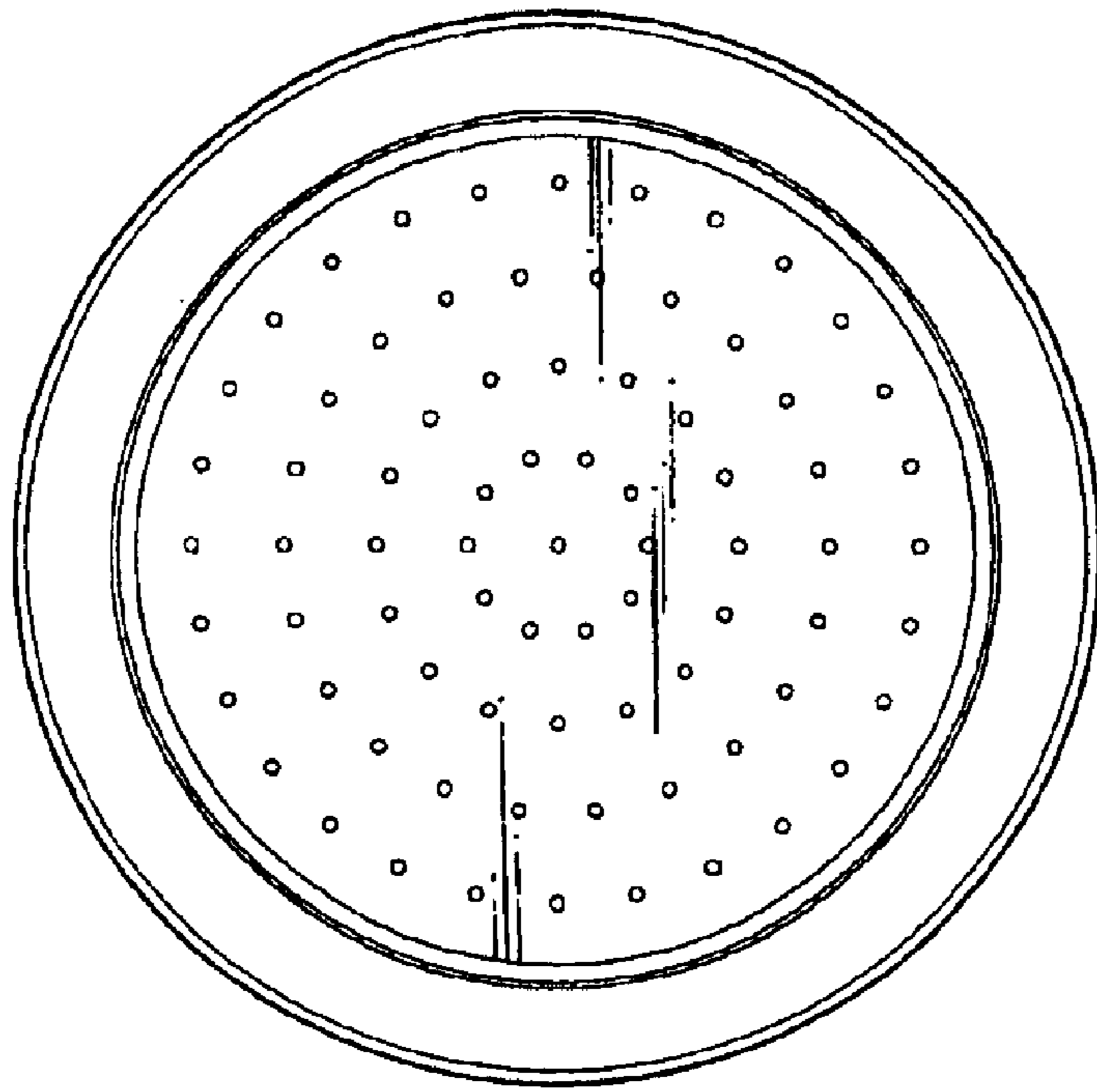
**FIG. 3**



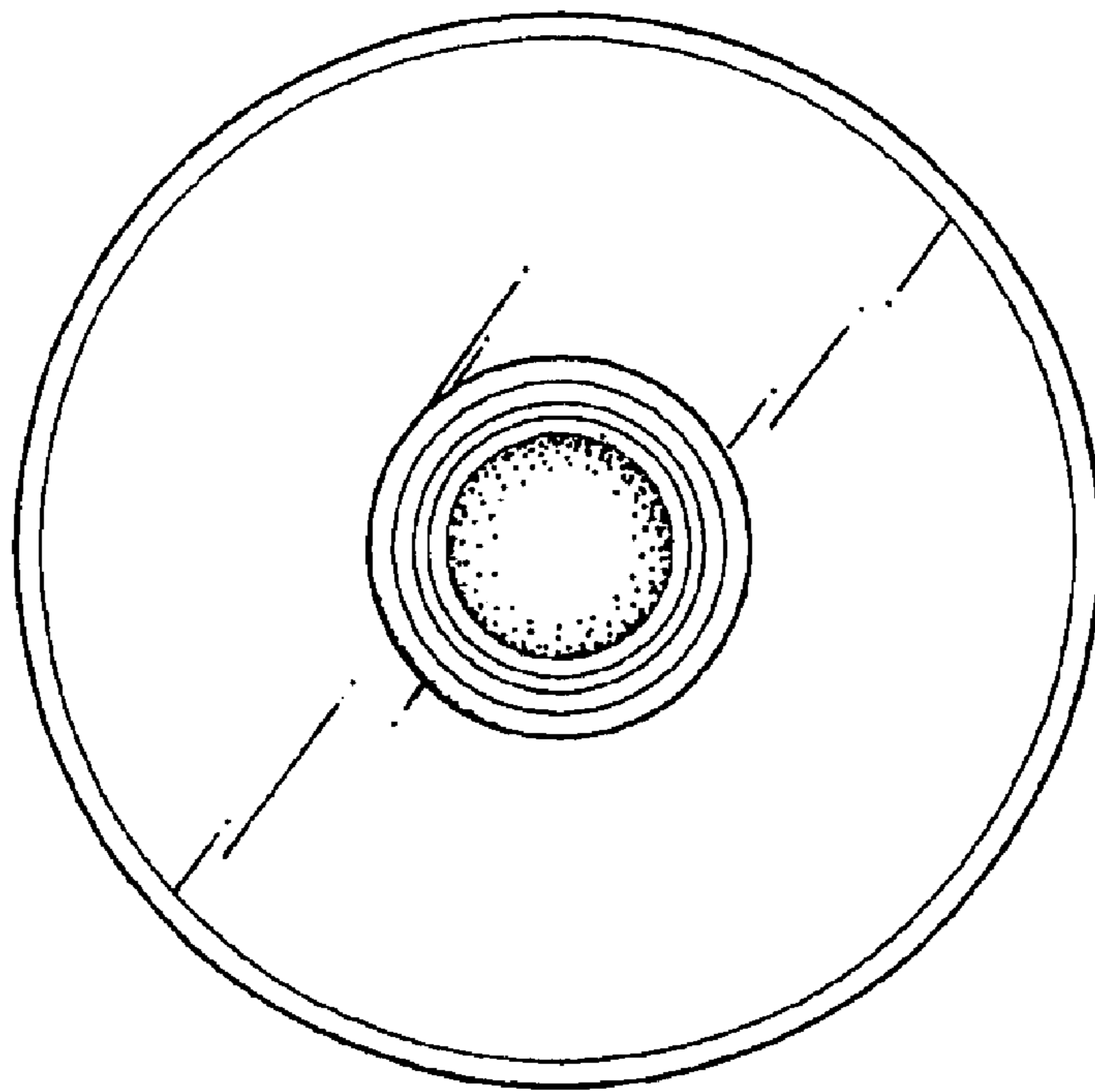
**FIG. 5**



**FIG. 4**



**FIG. 6**



**FIG. 7**