



US00D503392S

(12) **United States Design Patent**
Naito et al.

(10) **Patent No.:** **US D503,392 S**
(45) **Date of Patent:** **** Mar. 29, 2005**

(54) **DISC PLAYER**

D460,746 S * 7/2002 Zeitman D14/156
D466,490 S * 12/2002 Zeitman D14/156
D470,469 S 2/2003 Hirano

(75) Inventors: **Takahiro Naito**, Tokyo (JP); **Koichi Maruta**, Saitama (JP)

OTHER PUBLICATIONS

(73) Assignee: **Sony Corporation**, Tokyo (JP)

Web page "D-CJ01", 1 sheet, Sony (Nov. 2003).
Web page "Rio Volt SP 150" www.yodobashi.com, 1 sheet,
Yodobashi Camera (Nov. 2003).

(**) Term: **14 Years**

* cited by examiner

(21) Appl. No.: **29/197,400**

(22) Filed: **Jan. 15, 2004**

Primary Examiner—Nanda Bondade
(74) *Attorney, Agent, or Firm*—Rader, Fishman & Grauer
PLLC

(51) **LOC (7) Cl.** **14-01**

(52) **U.S. Cl.** **D14/156**

(58) **Field of Search** D14/135-136,
D14/156-157, 160-165, 167-168, 192-198,
217; 455/347-351; 369/75.1, 75.2, 77.1,
77.2

(57) **CLAIM**

The ornamental design for a disc player, as shown.

DESCRIPTION

FIG. 1 is a perspective view of a disc player showing our new design;

FIG. 2 is a front elevational view thereof;

FIG. 3 is a rear elevational view thereof;

FIG. 4 is a left side elevational view thereof;

FIG. 5 is a right side elevational view thereof;

FIG. 6 is a top plan view thereof; and,

FIG. 7 is a bottom plan view thereof.

(56) **References Cited**

U.S. PATENT DOCUMENTS

D431,543 S 10/2000 Yuyama
D431,544 S 10/2000 Kobayashi
D433,672 S 11/2000 Kobayashi
D441,736 S * 5/2001 Yoneda D14/156
D451,080 S 11/2001 Kataoka
D457,871 S 5/2002 Kobayashi
D460,061 S * 7/2002 Zeitman D14/156

1 Claim, 4 Drawing Sheets

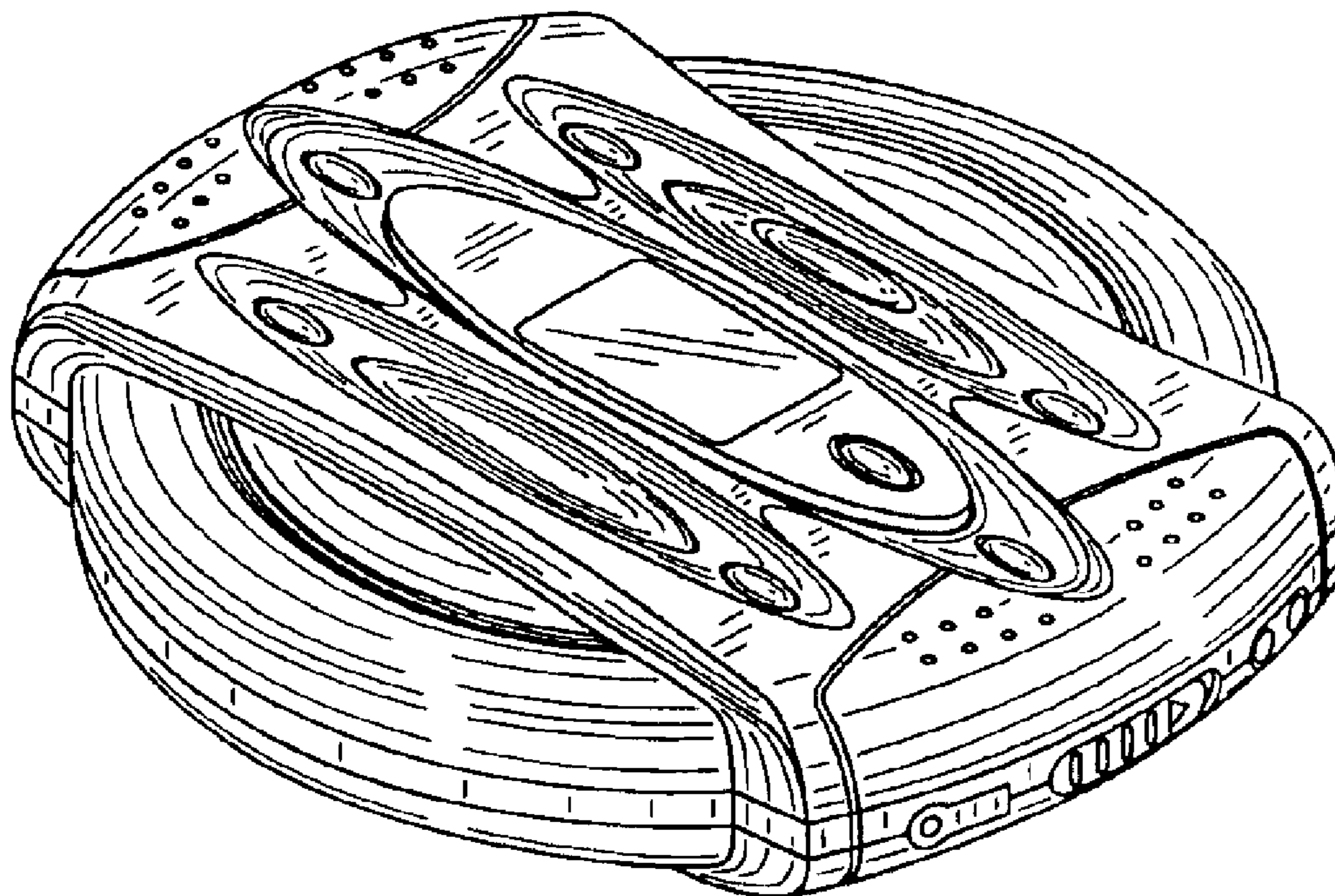

Fig. 1

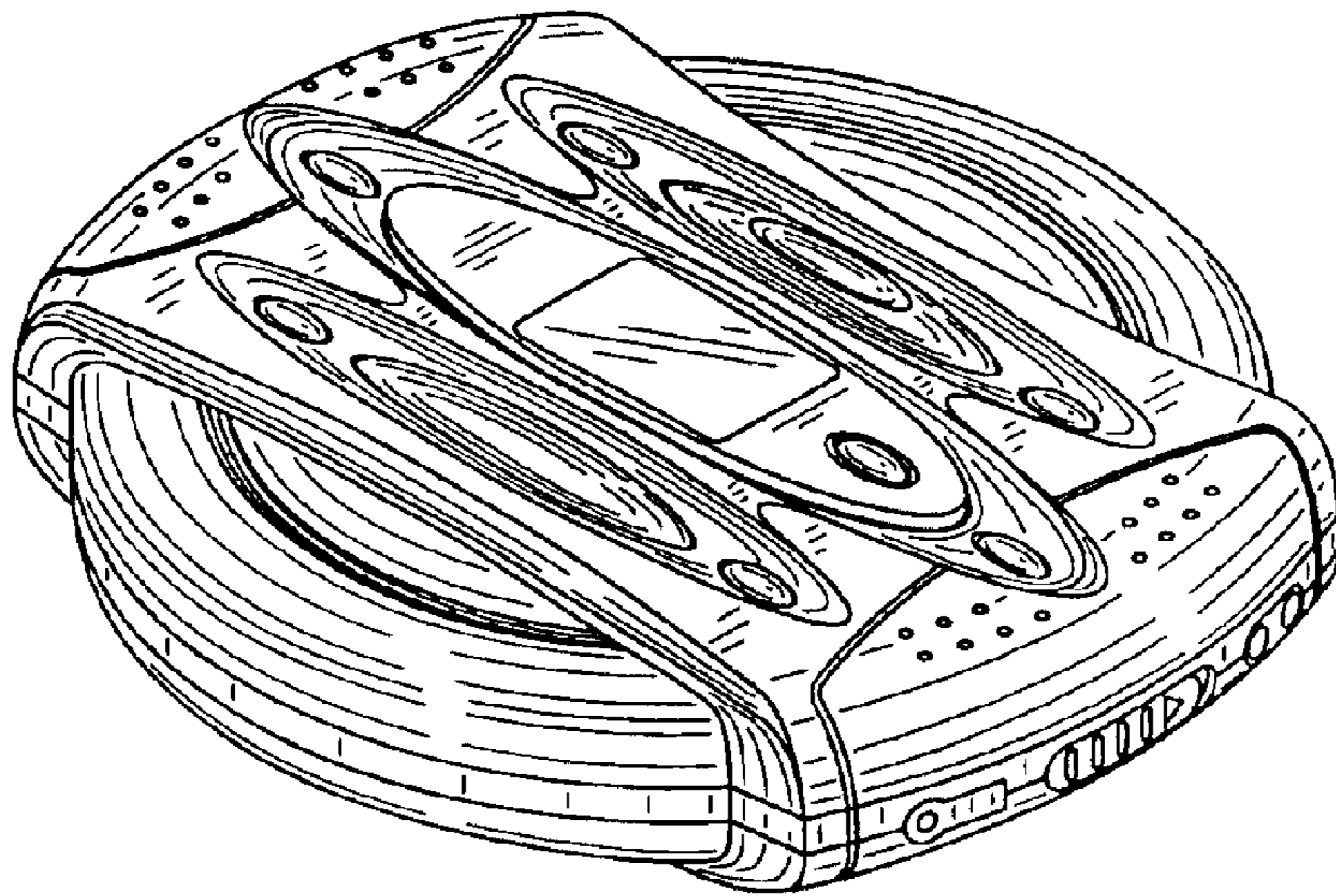

Fig.2

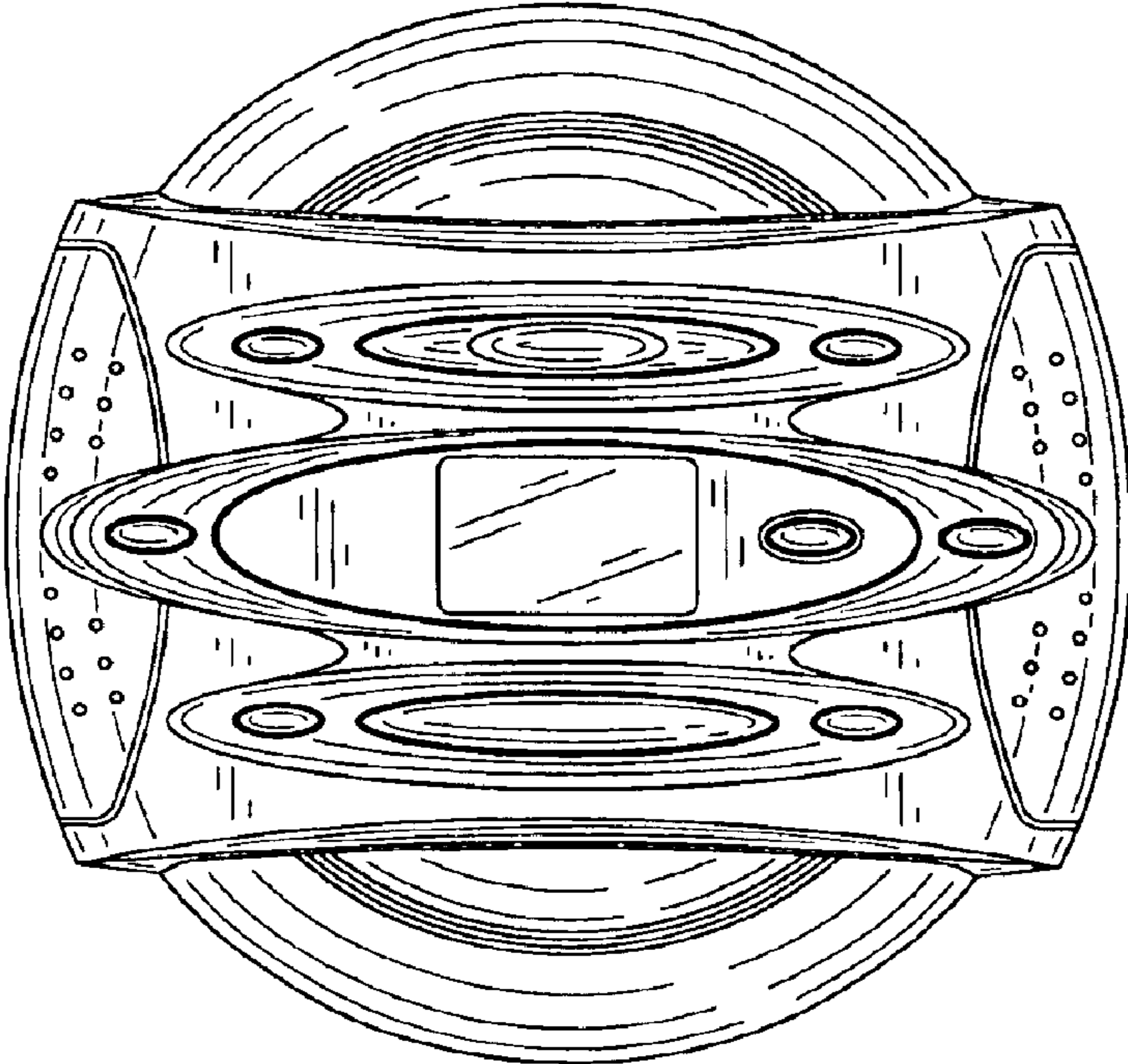

Fig.3

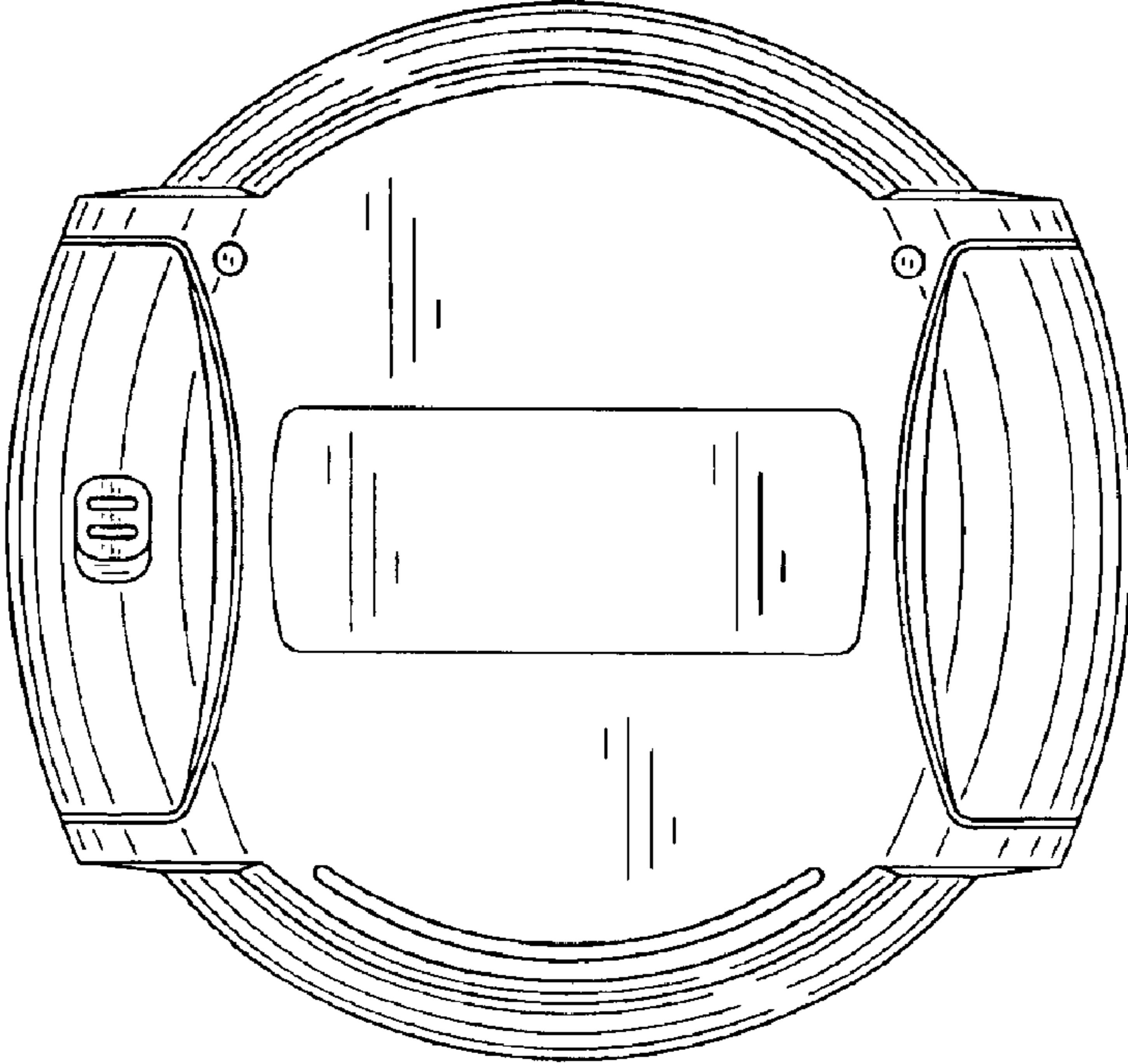

Fig.4

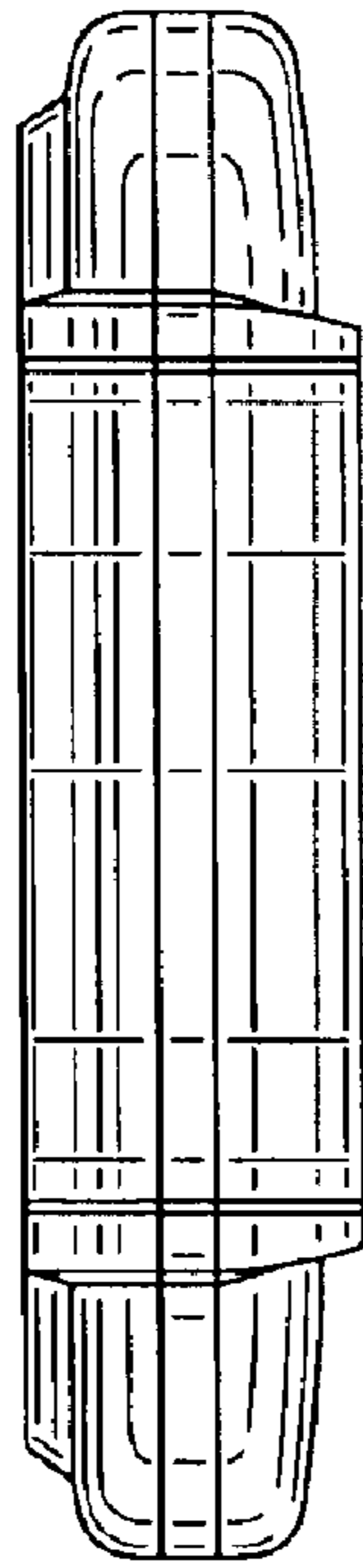

Fig.5

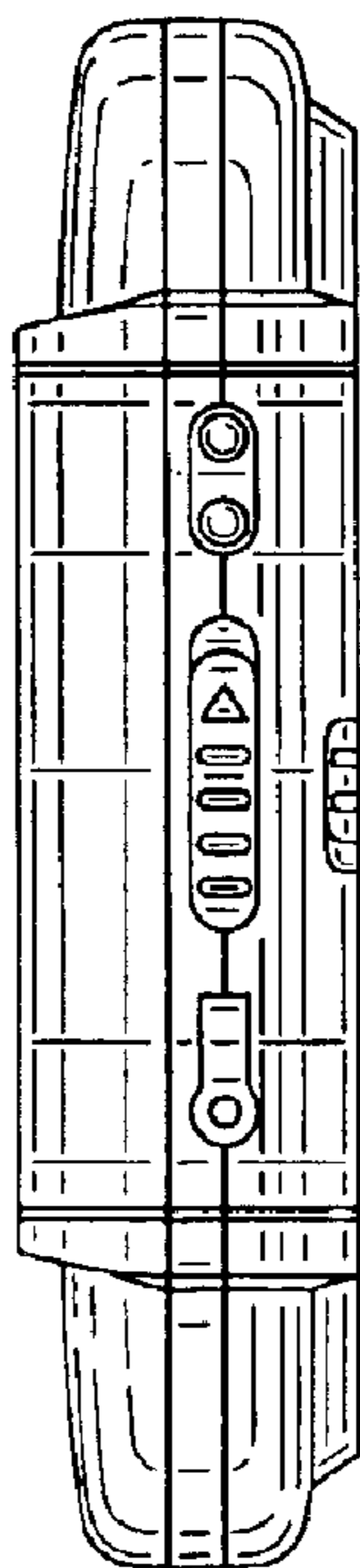

Fig.6

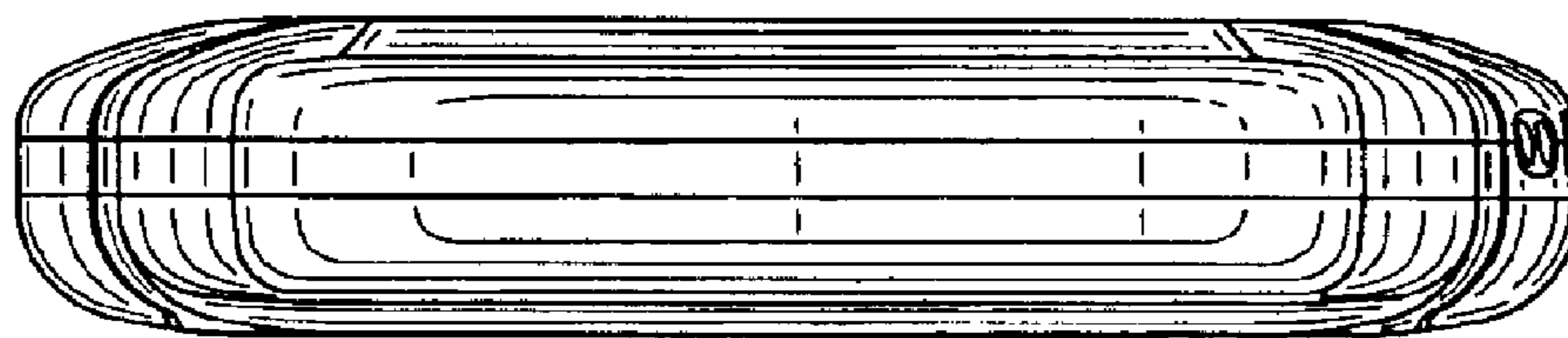

Fig.7

