

US00D503321S

(12) **United States Design Patent**
Harris

(10) **Patent No.:** **US D503,321 S**
(45) **Date of Patent:** **** Mar. 29, 2005**

(54) **STAPLER**

(75) **Inventor:** **Mark Harris, McHenry, IL (US)**

(73) **Assignee:** **ACCO Brands, Inc., Lincolnshire, IL (US)**

(**) **Term:** **14 Years**

(21) **Appl. No.:** **29/203,839**

(22) **Filed:** **Apr. 20, 2004**

(51) **LOC (7) Cl.** **19-02**

(52) **U.S. Cl.** **D8/50; D19/72**

(58) **Field of Search** **D8/49, 50; D19/72;**
227/120, 126, 127, 128, 131, 132, 134,
156

(56) **References Cited**

U.S. PATENT DOCUMENTS

4,726,505	A	2/1988	Okazaki	
D319,377	S	* 8/1991	Sadashima et al.	D8/49
5,076,483	A	12/1991	Olesen	
D336,838	S	6/1993	Ishii	
5,222,645	A	6/1993	Sueda	
D374,385	S	* 10/1996	Herbst et al.	D8/50
6,068,173	A	5/2000	Sueda	
D445,323	S	* 7/2001	Arns	D8/50
D467,778	S	* 12/2002	Nolan	D8/50
6,547,119	B2	4/2003	Huang	
D475,905	S	* 6/2003	Kroger	D8/50
2003/0197045	A1	10/2003	Luo	
2004/0060959	A1	4/2004	Ura	

OTHER PUBLICATIONS

Isaberg Rapid AB Staplers Catalog, 1999 p. 2 (Rapid fashion 4 stapler).*

Acco Brands, Inc., Fact Book 2001, Feb. 1, 2001, pp. 188–189.

Acco Brands, Inc., Fact Book 2003, Feb. 1, 2003, pp. 98, 99 and 110–112.

* cited by examiner

Primary Examiner—Adir Aronovich

(74) *Attorney, Agent, or Firm*—Michael Best & Friedrich LLP

(57) **CLAIM**

The ornamental design for a stapler, as shown and described.

DESCRIPTION

FIG. 1 is a left-side perspective view, taken from the front, of a stapler embodying the present invention.

FIG. 2 is a right-side perspective view taken from the front of the stapler.

FIG. 3 is a left-side perspective view taken from the rear of the stapler.

FIG. 4 is a left side view of the stapler.

FIG. 5 is a front view of the stapler.

FIG. 6 is a top view of the stapler; and,

FIG. 7 is a rear view of the stapler.

The portions of the stapler shown in broken lines are for illustrative purposes only and form no part of the claimed design. The side view opposite FIG. 4 is a mirror image of FIG. 4 and is not shown.

1 Claim, 4 Drawing Sheets

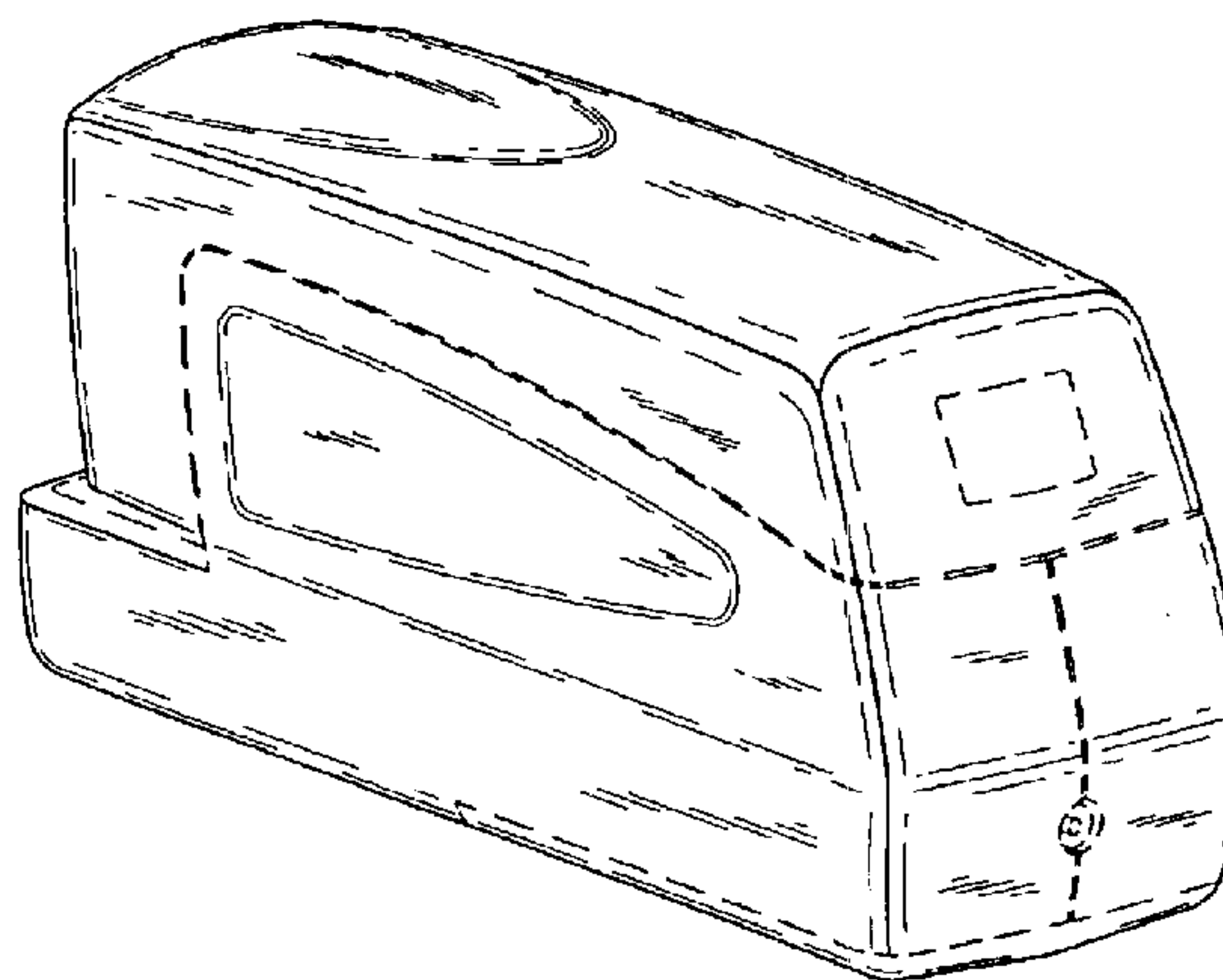
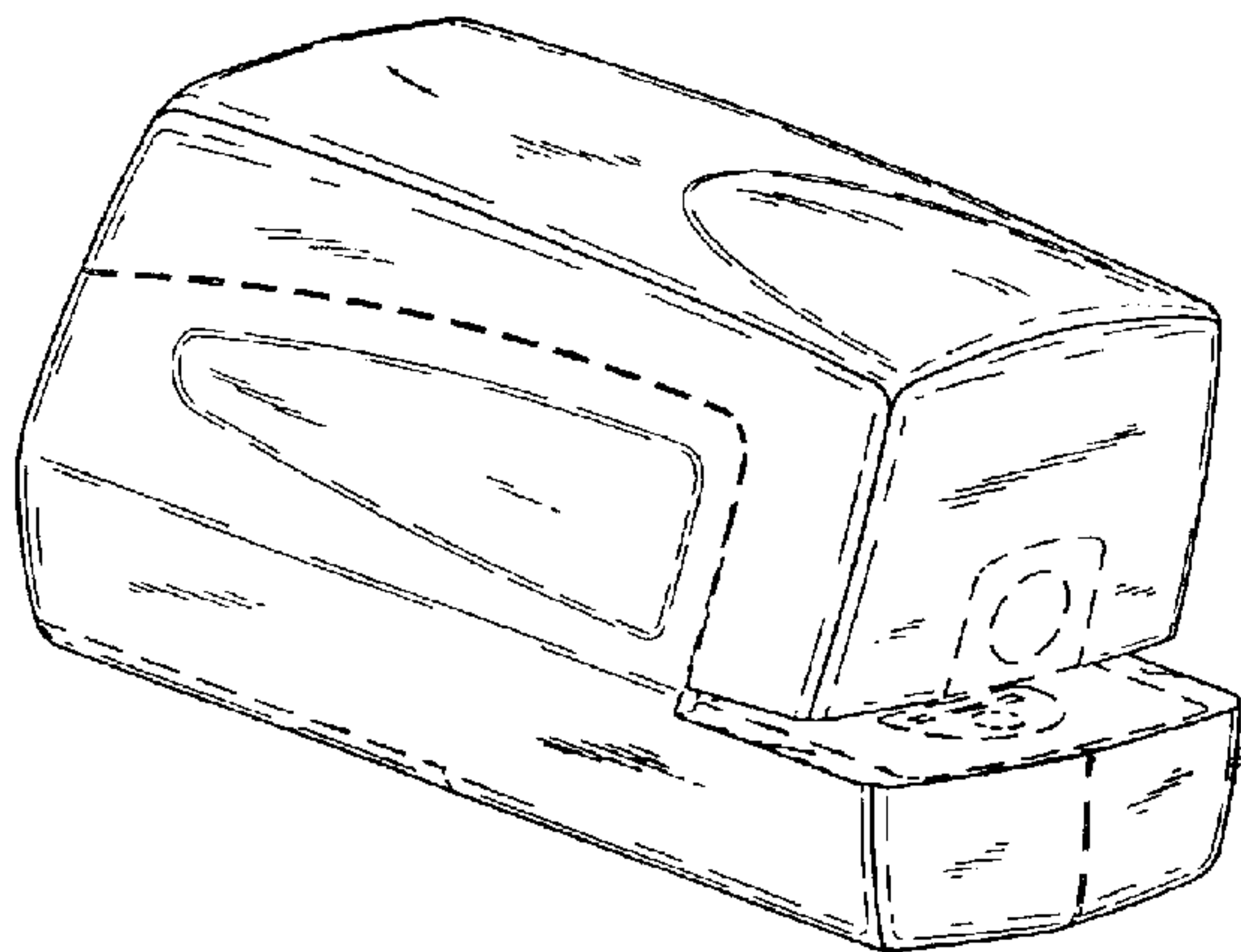

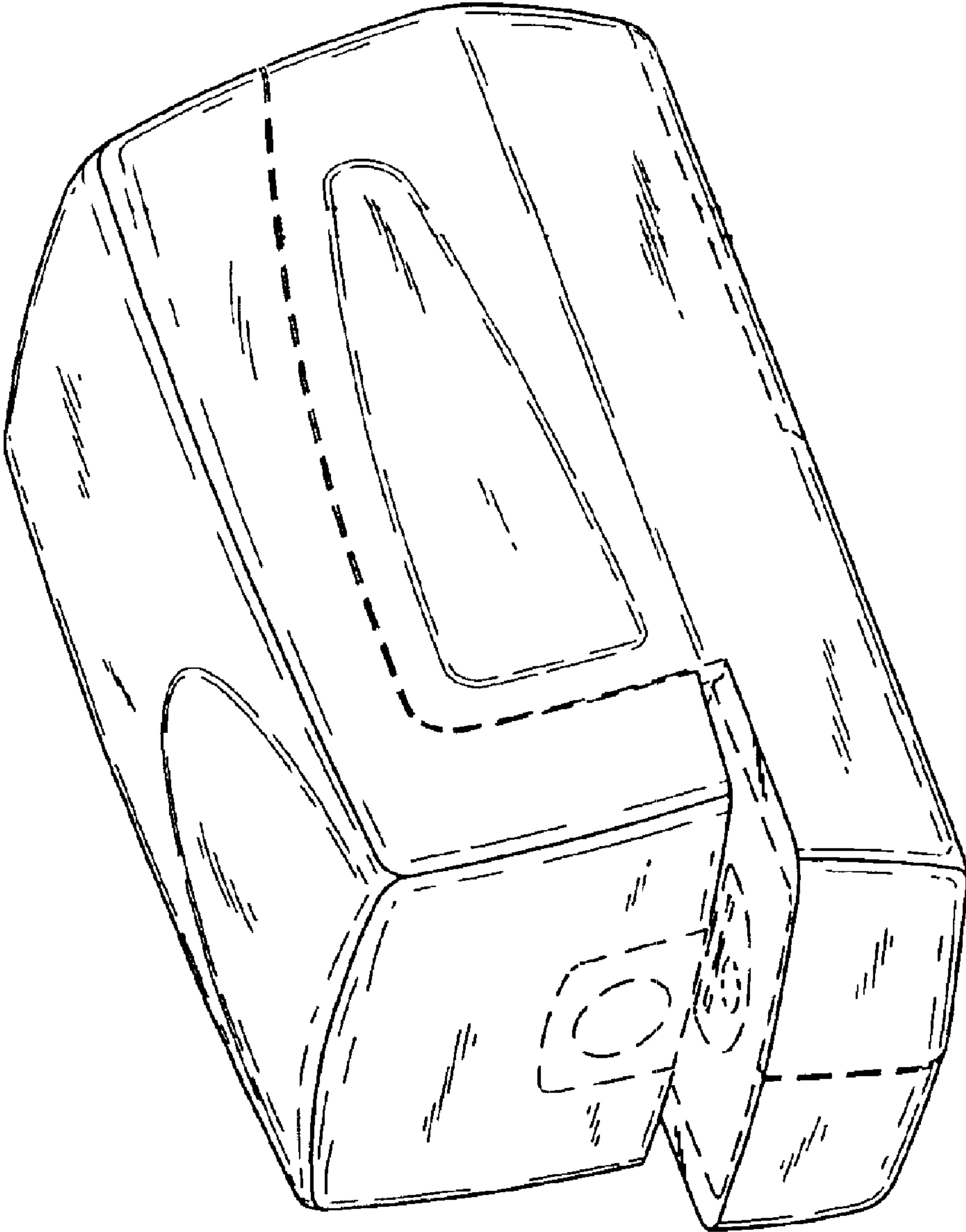

FIG. 1

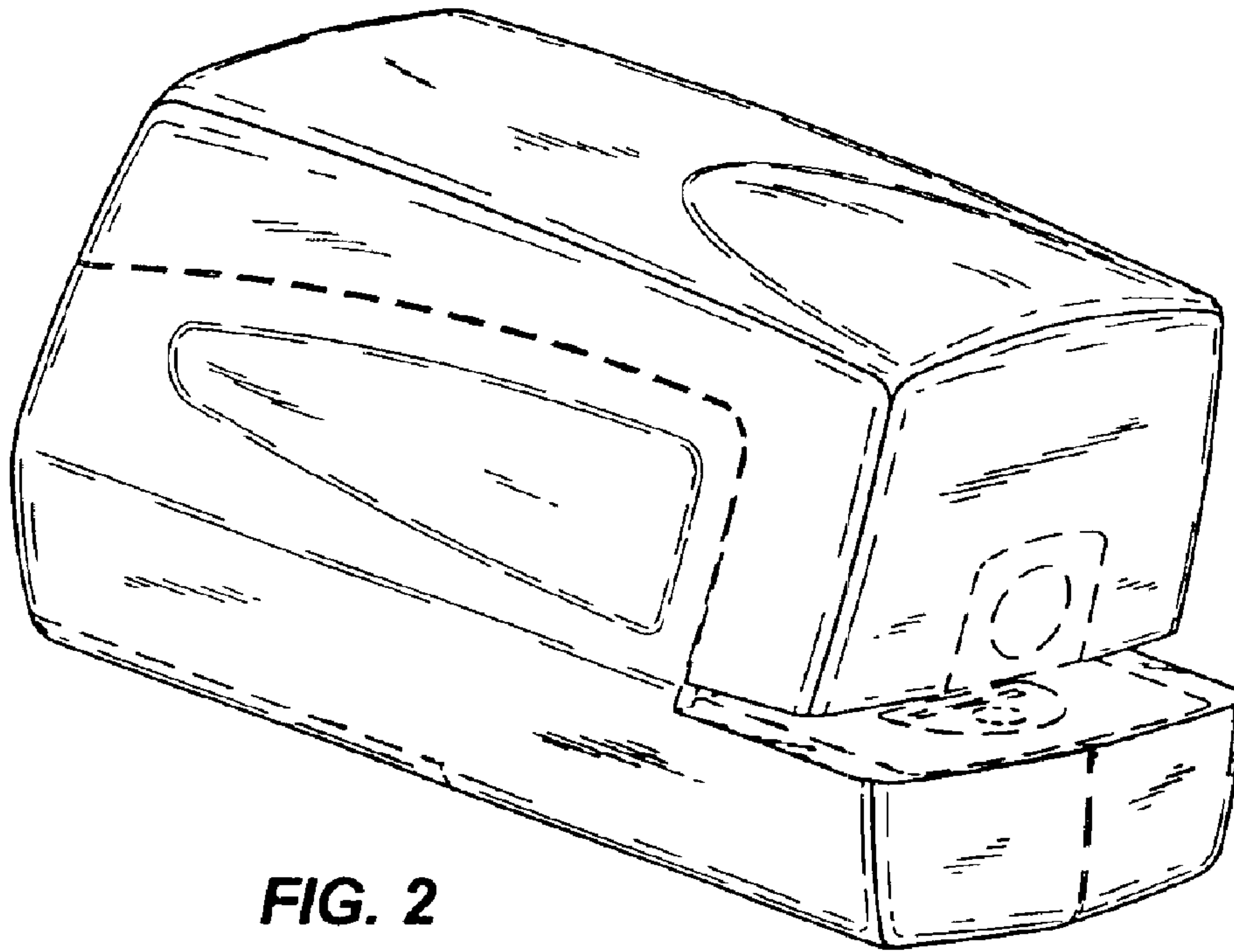

FIG. 2

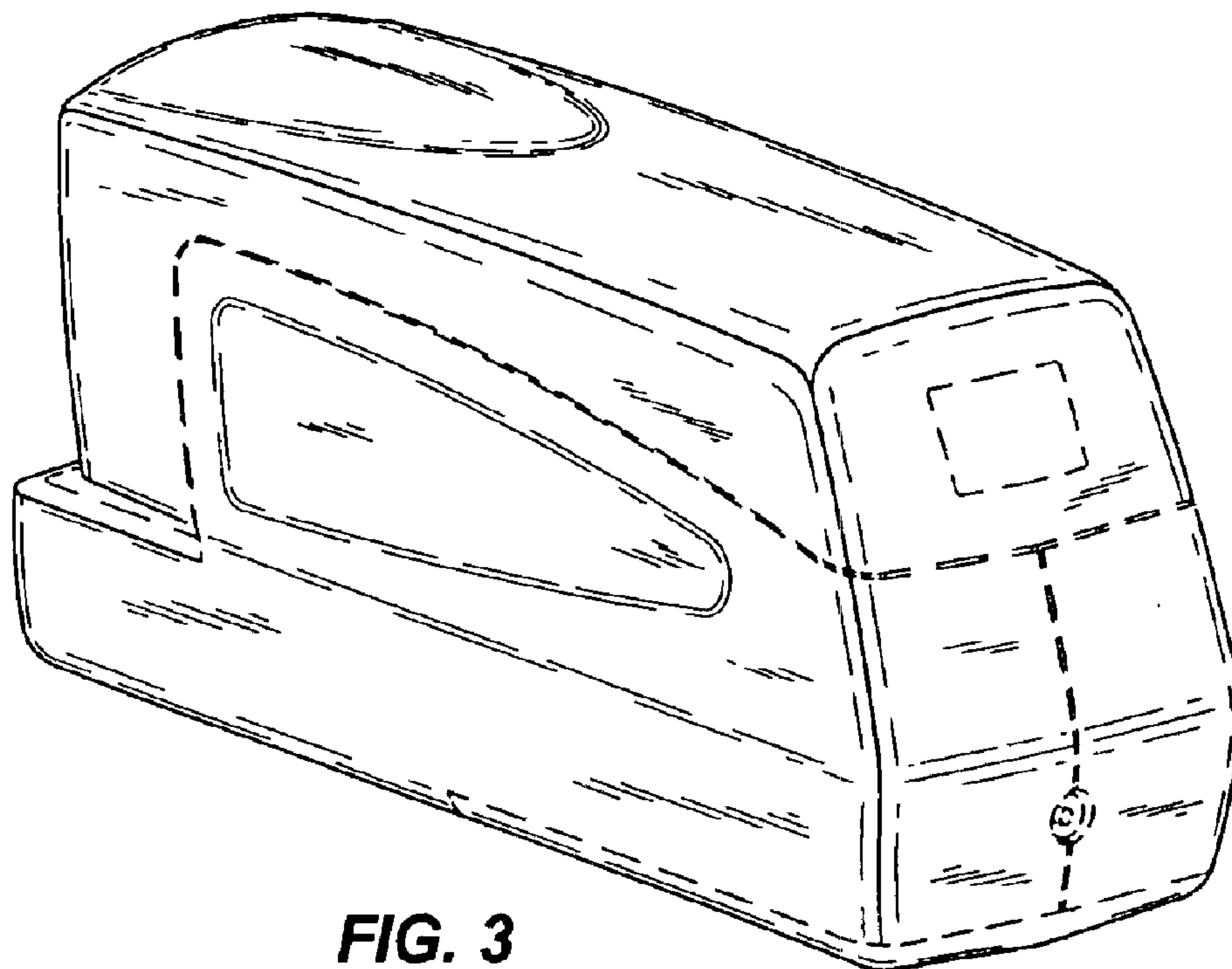

FIG. 3

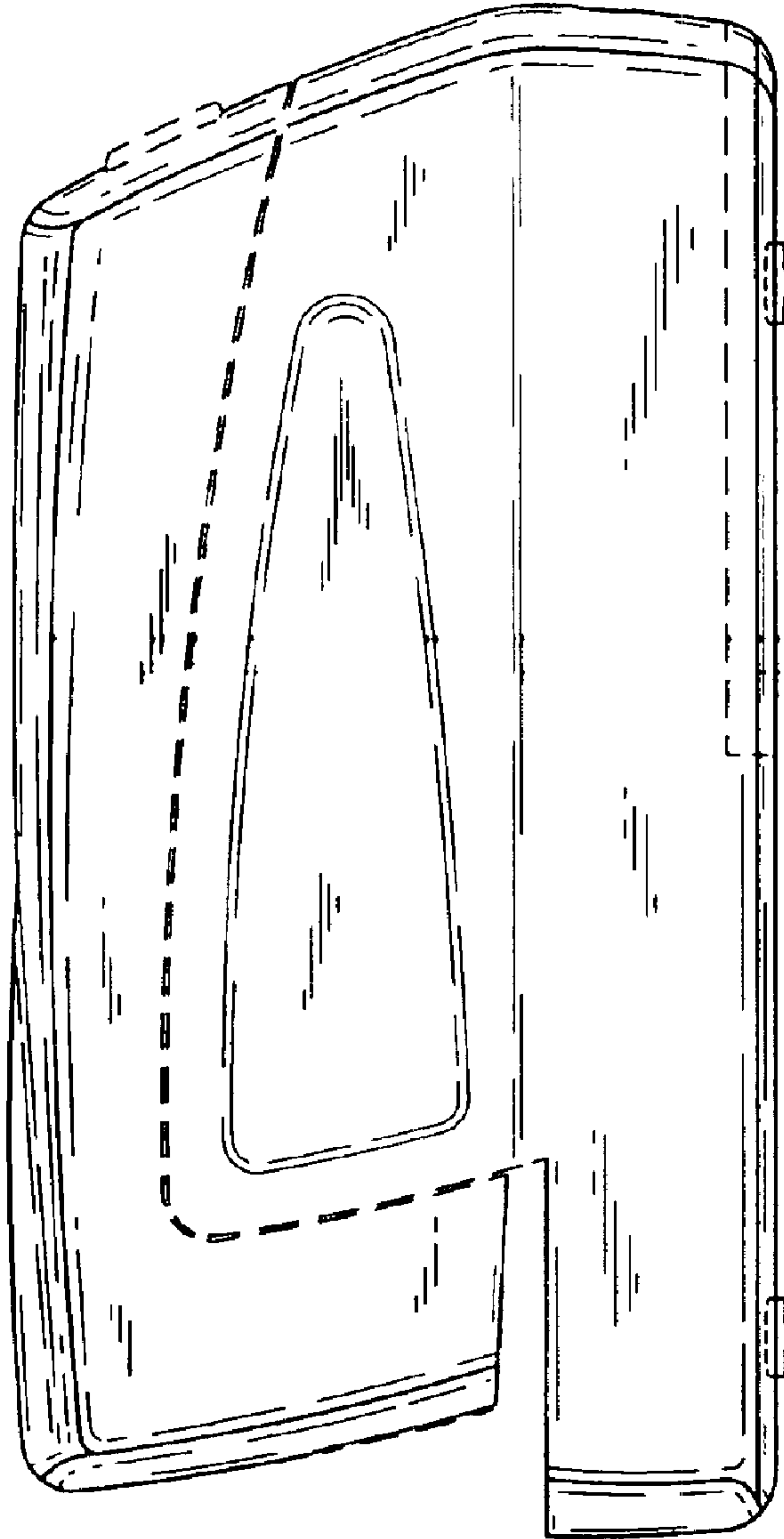

FIG. 4

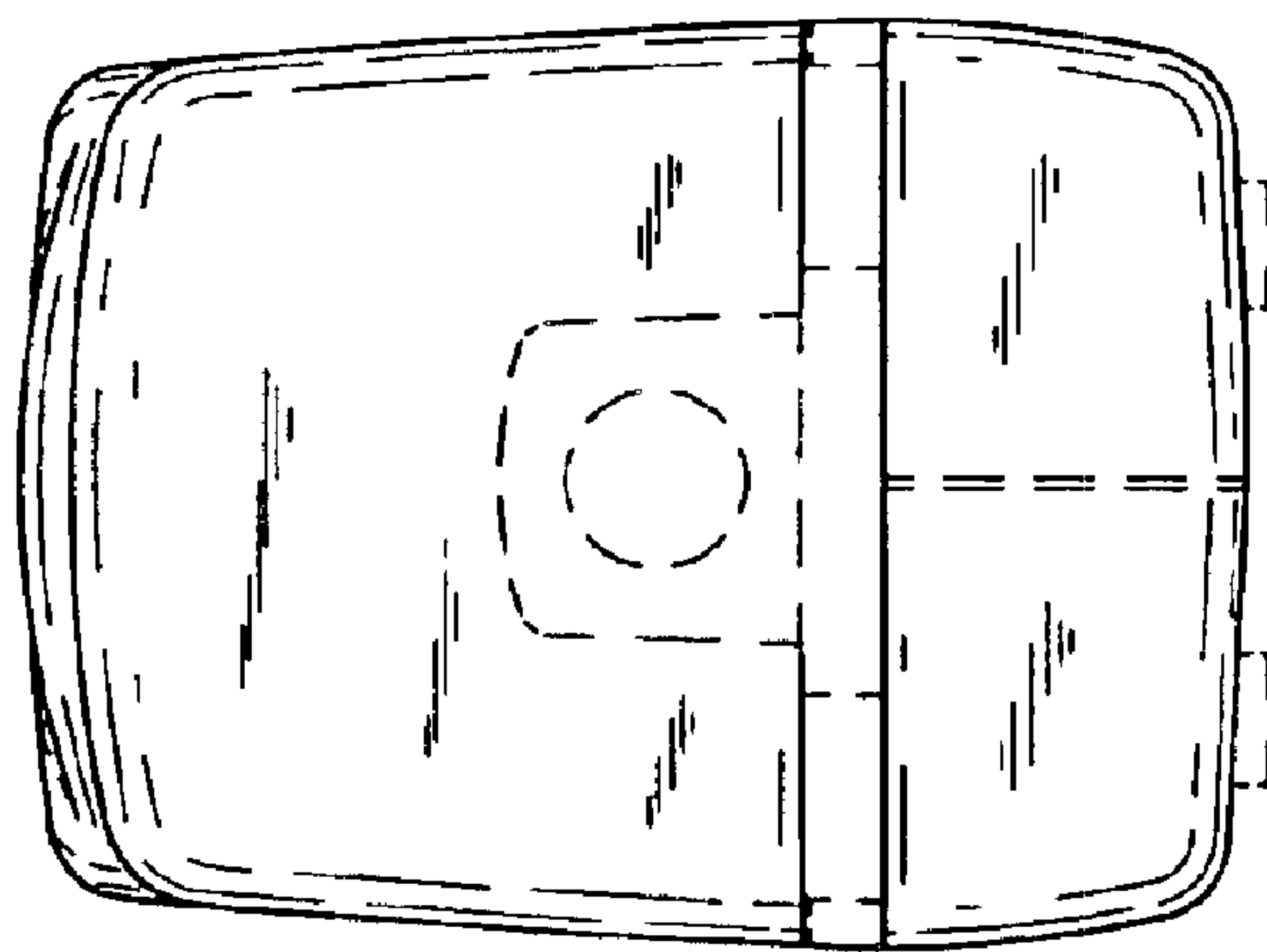

FIG. 5

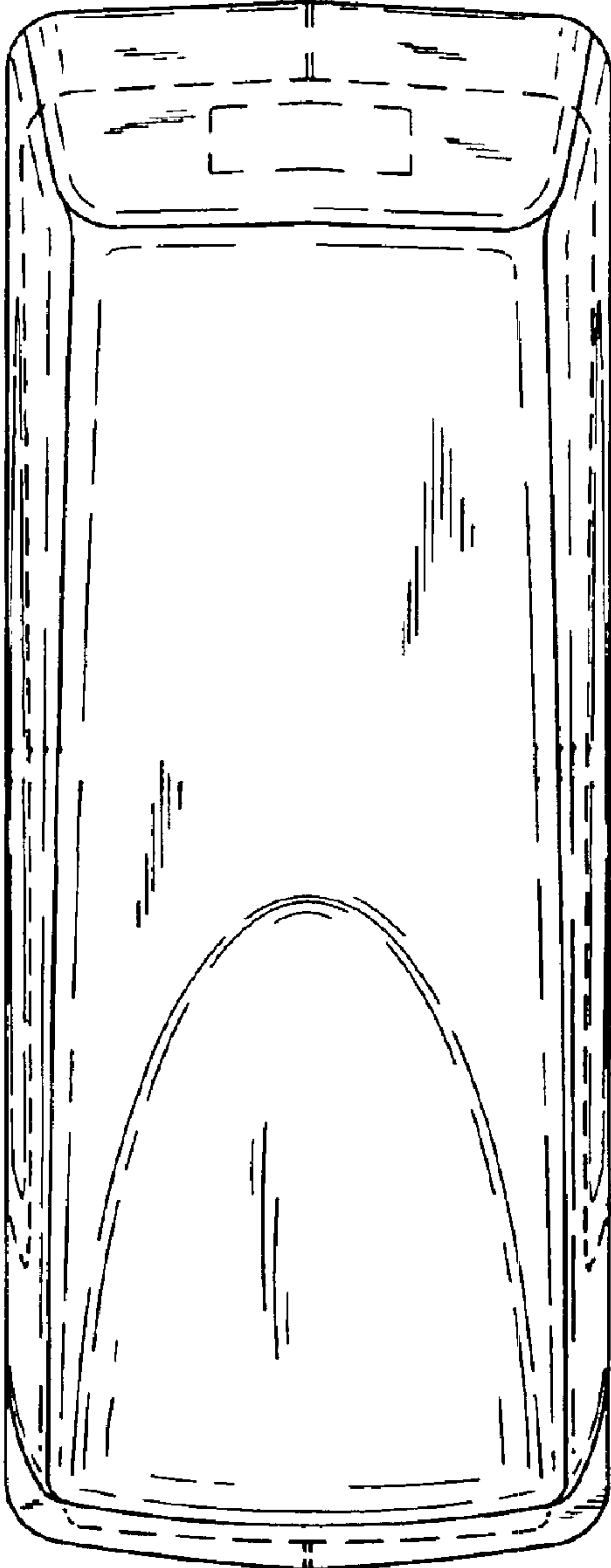

FIG. 6

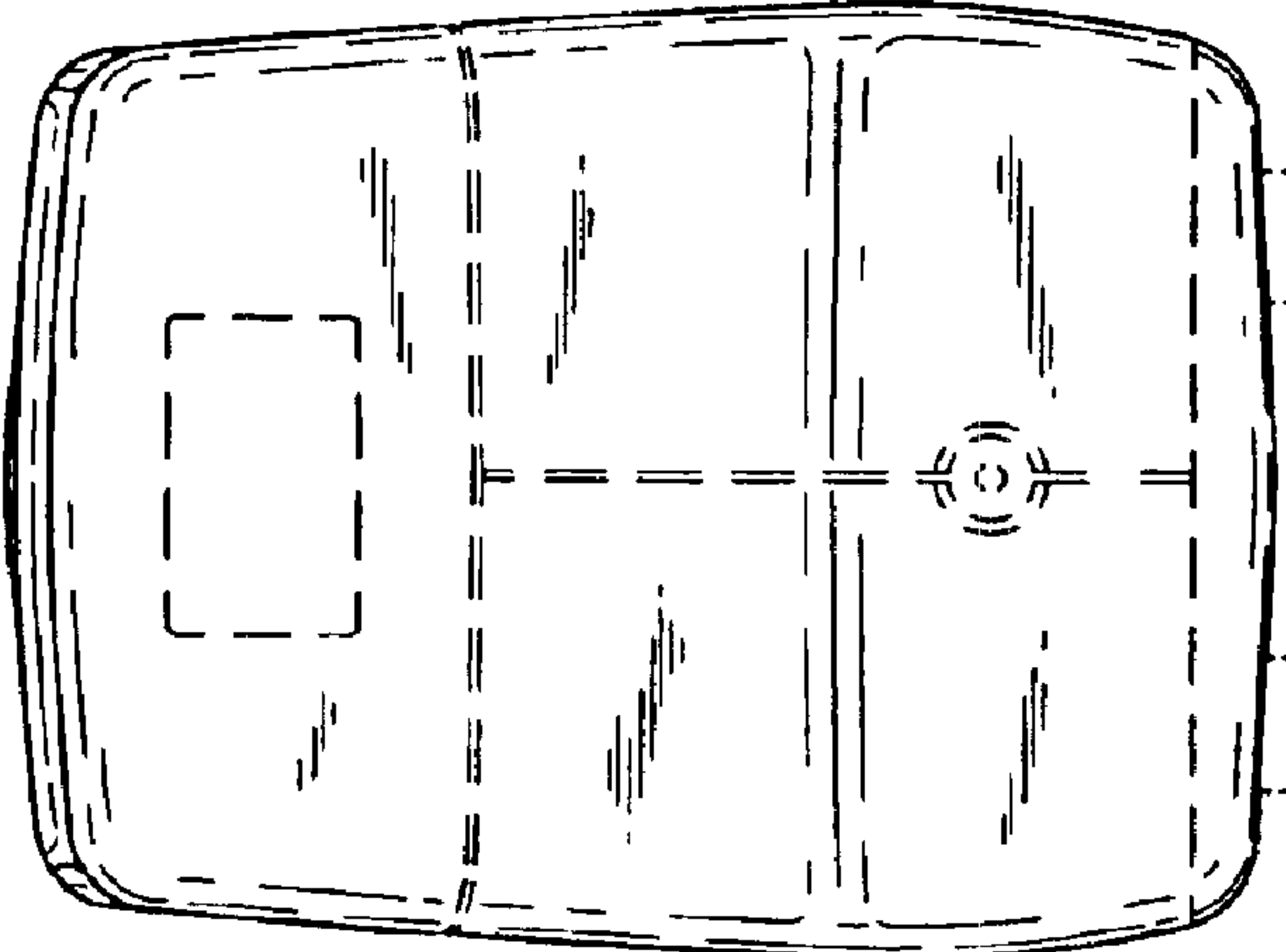

FIG. 7