

US00D503298S

(12) **United States Design Patent**  
**Juneau**

(10) **Patent No.:** **US D503,298 S**  
(45) **Date of Patent:** **\*\* Mar. 29, 2005**

(54) **TABLE**

(75) **Inventor:** **Alain Juneau**, St-Jean-Chrysostome  
(CA)

(73) **Assignee:** **Baronet, Inc.** (CA)

(\*\*) **Term:** **14 Years**

(21) **Appl. No.:** **29/178,132**

(22) **Filed:** **Mar. 21, 2003**

(51) **LOC (7) Cl.** ..... **06-03**

(52) **U.S. Cl.** ..... **D6/480**

(58) **Field of Search** ..... D6/480-489, 495,  
D6/429-431; 108/153.1, 155, 156, 157.1,  
161, 65, 69, 70, 77; 248/188, 188.1, 188.9,  
188.8

(56) **References Cited**

**U.S. PATENT DOCUMENTS**

D121,062 S	6/1940	Bach	
2,614,013 A	* 10/1952	Langius	108/69
2,643,924 A	* 6/1953	Albano	108/77
2,734,788 A	* 2/1956	Elles et al.	108/79
D205,291 S	* 7/1966	Klein et al.	D6/430
3,419,317 A	* 12/1968	Mutchnik et al.	384/17
D452,624 S	1/2002	de Blois	

\* cited by examiner

*Primary Examiner*—Janice Seeger  
(74) *Attorney, Agent, or Firm*—Saidman DesignLaw Group

(57) **CLAIM**

The ornamental design for a table, as shown and described.

**DESCRIPTION**

FIG. 1 is a perspective view of a first embodiment of a table showing my new design;  
FIG. 2 is a front view thereof, the rear view being identical;  
FIG. 3 is a right-side view thereof, the left-side view being identical;  
FIG. 4 is a top view thereof;  
FIG. 5 is a bottom view thereof;  
FIG. 6 is a perspective view of a second embodiment thereof;  
FIG. 7 is a front view thereof, the rear view being identical;  
FIG. 8 is a right-side view thereof, the left-side view being identical;  
FIG. 9 is a top view thereof; and,  
FIG. 10 is a bottom view thereof.  
The broken lines in the drawings form no part of the claimed design.

**1 Claim, 8 Drawing Sheets**

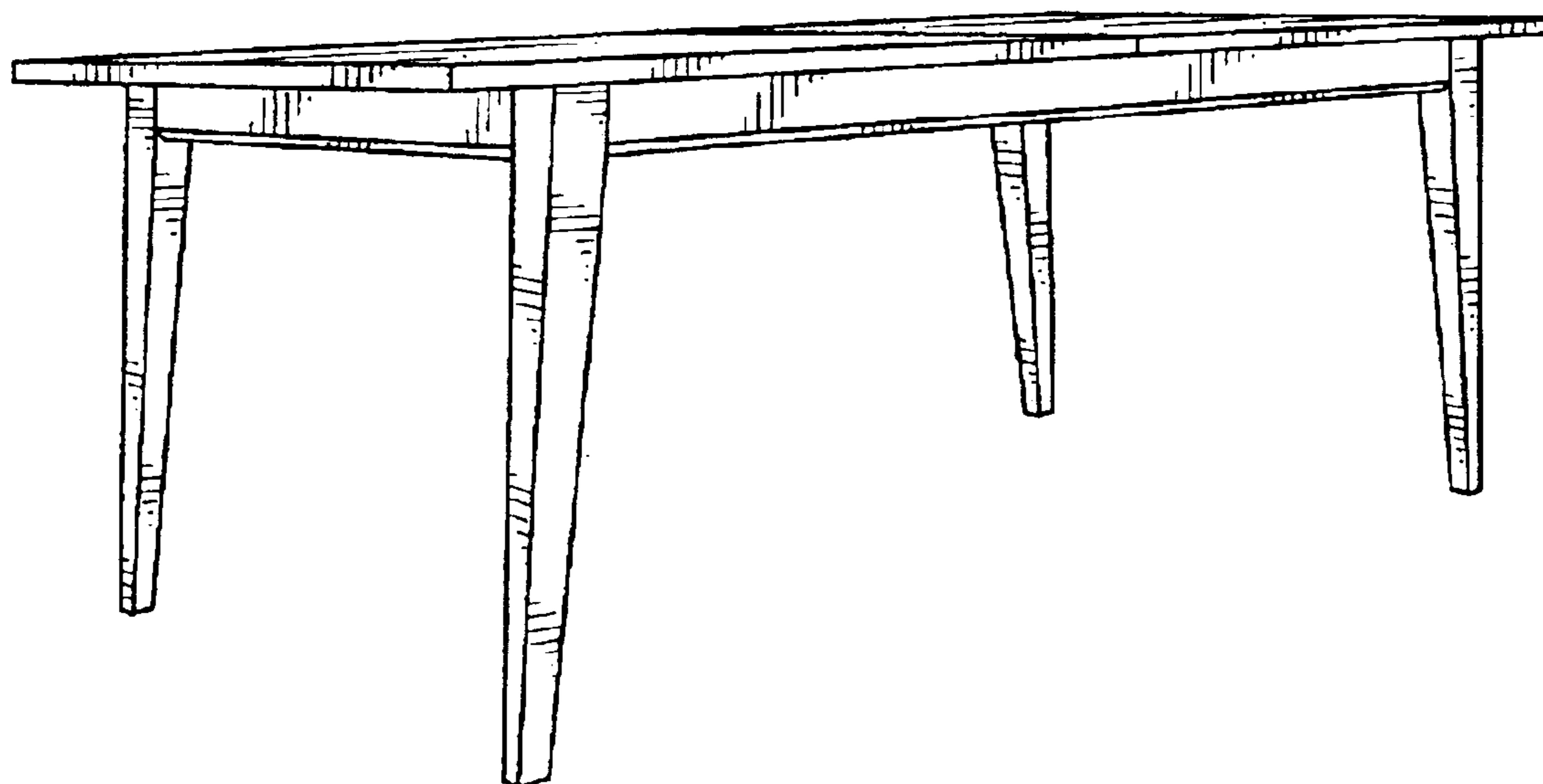

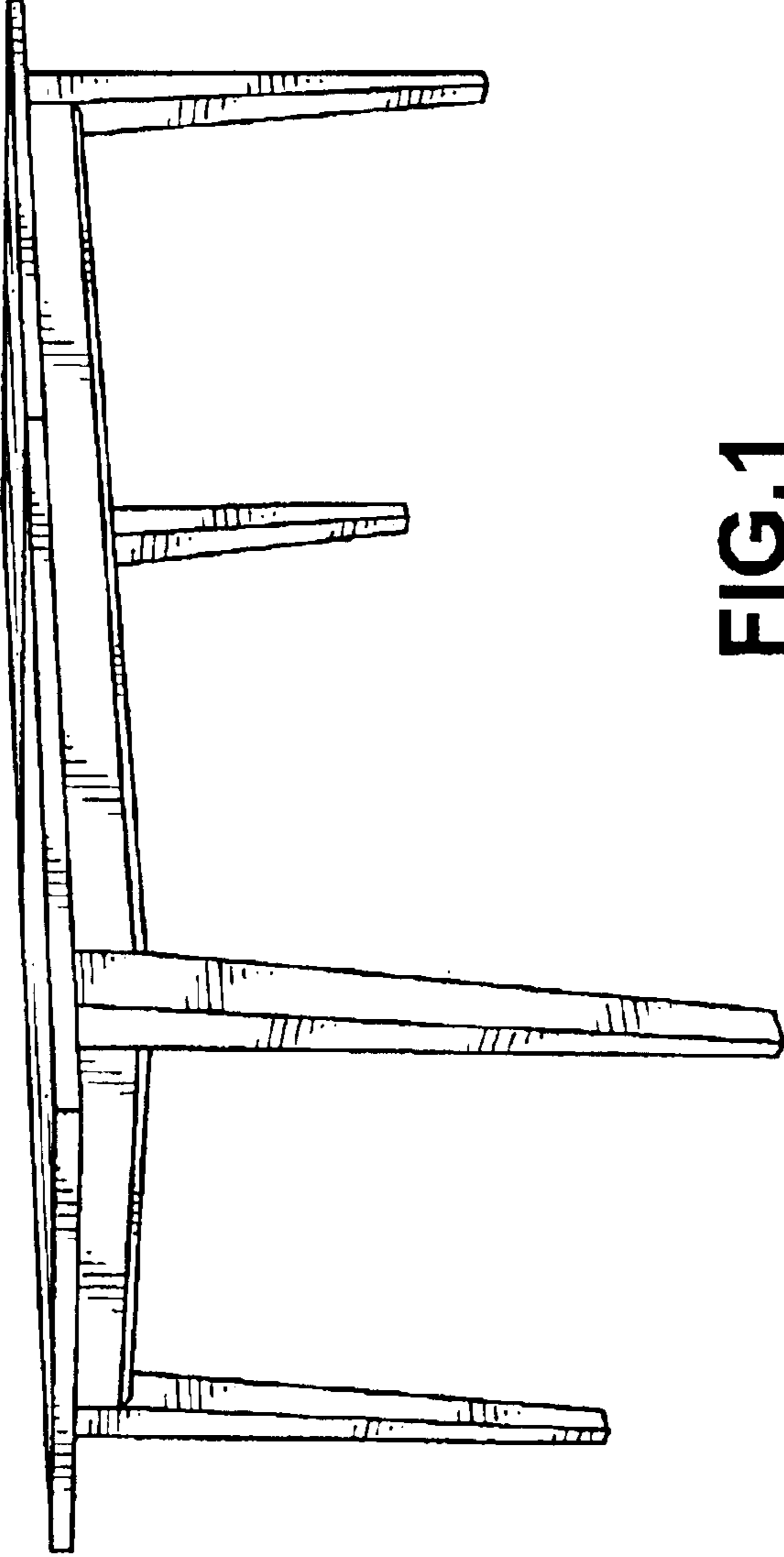

FIG. 1

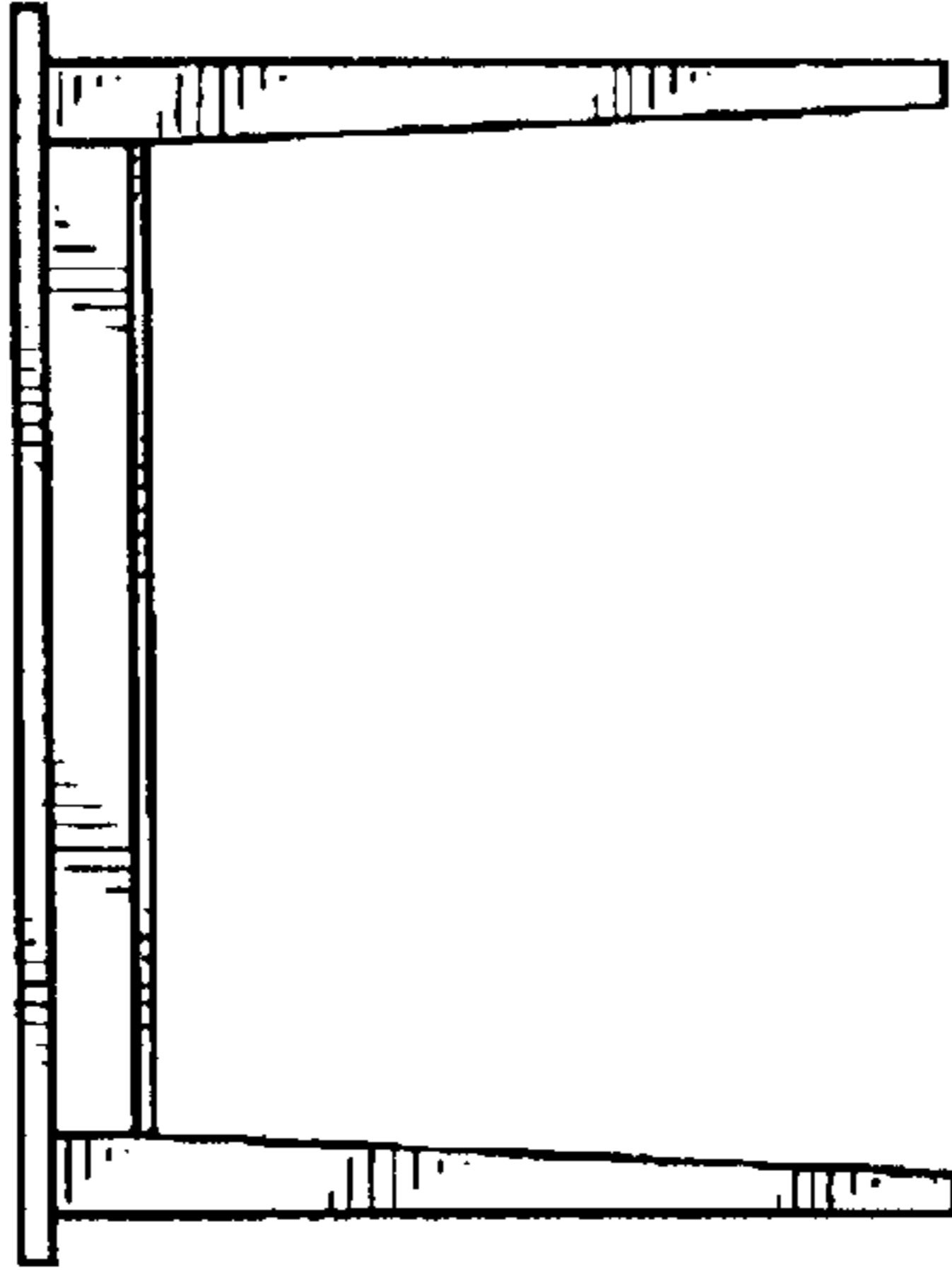

FIG.3

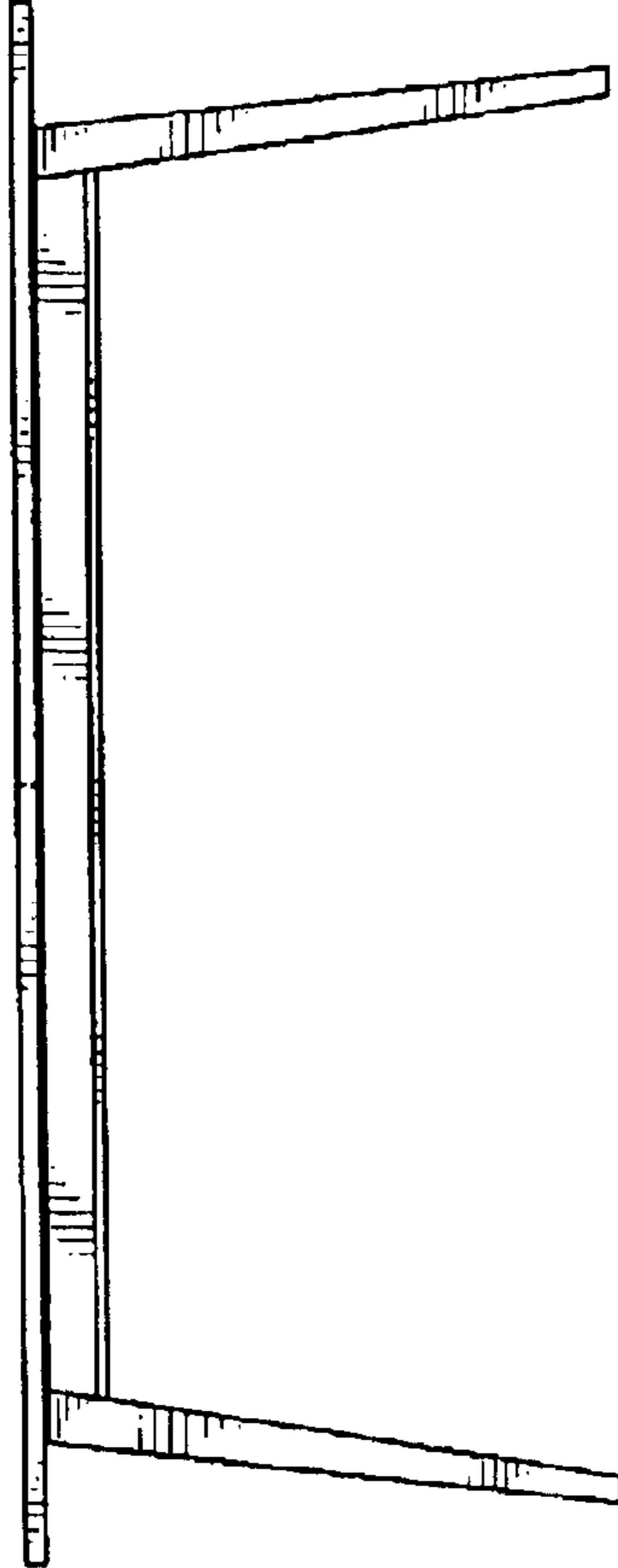
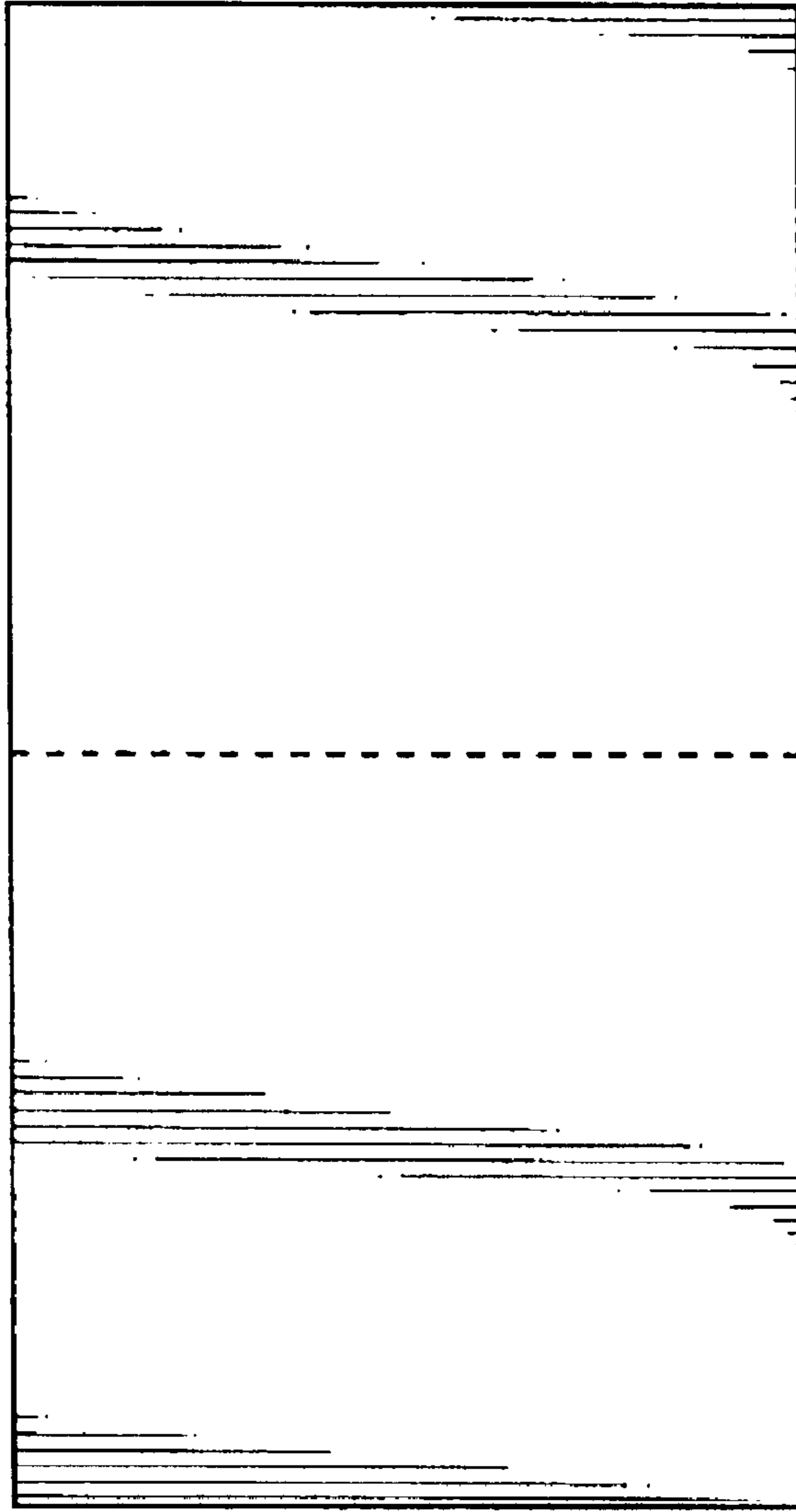

FIG.2



**FIG.4**

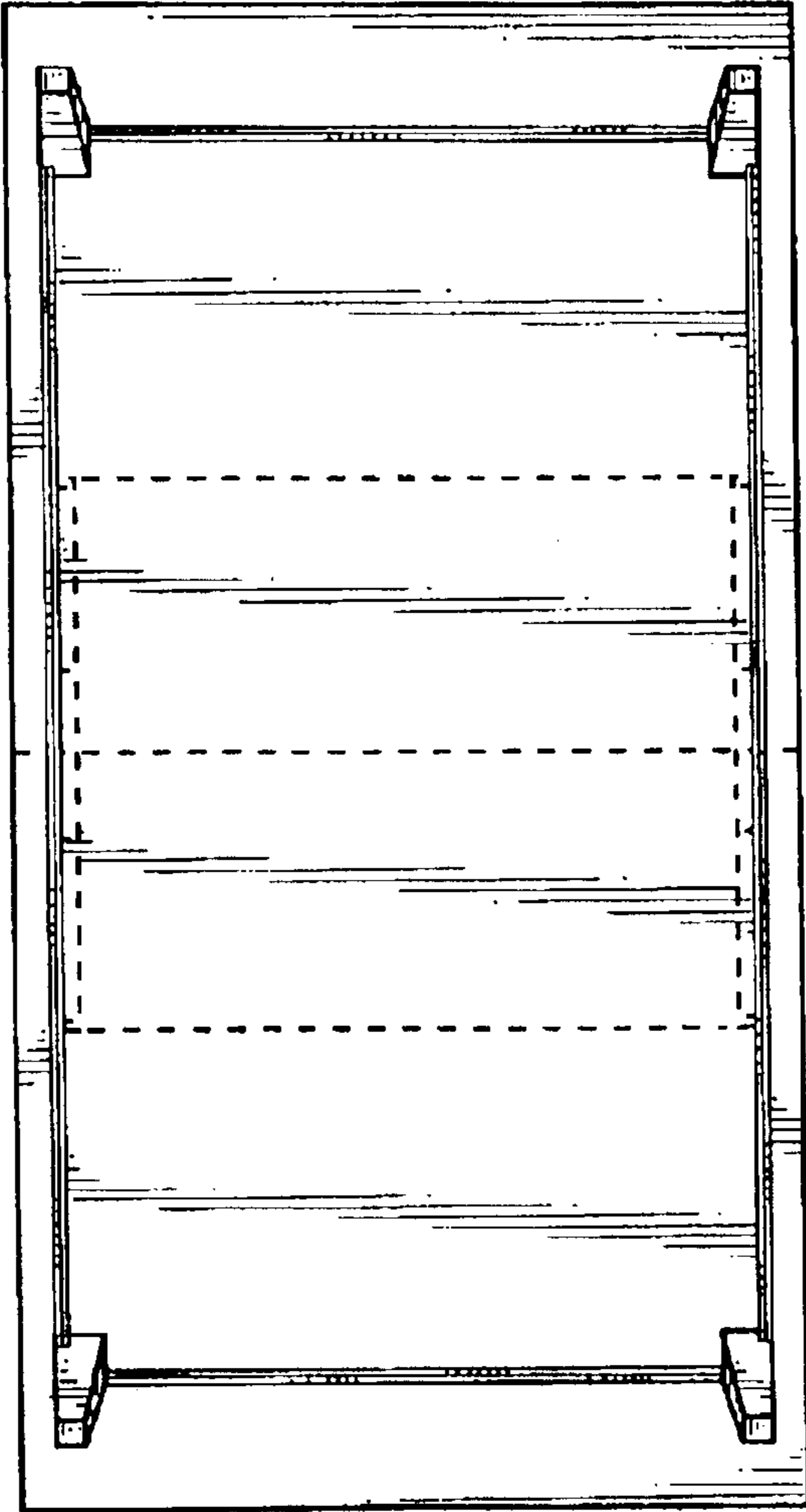

FIG. 5

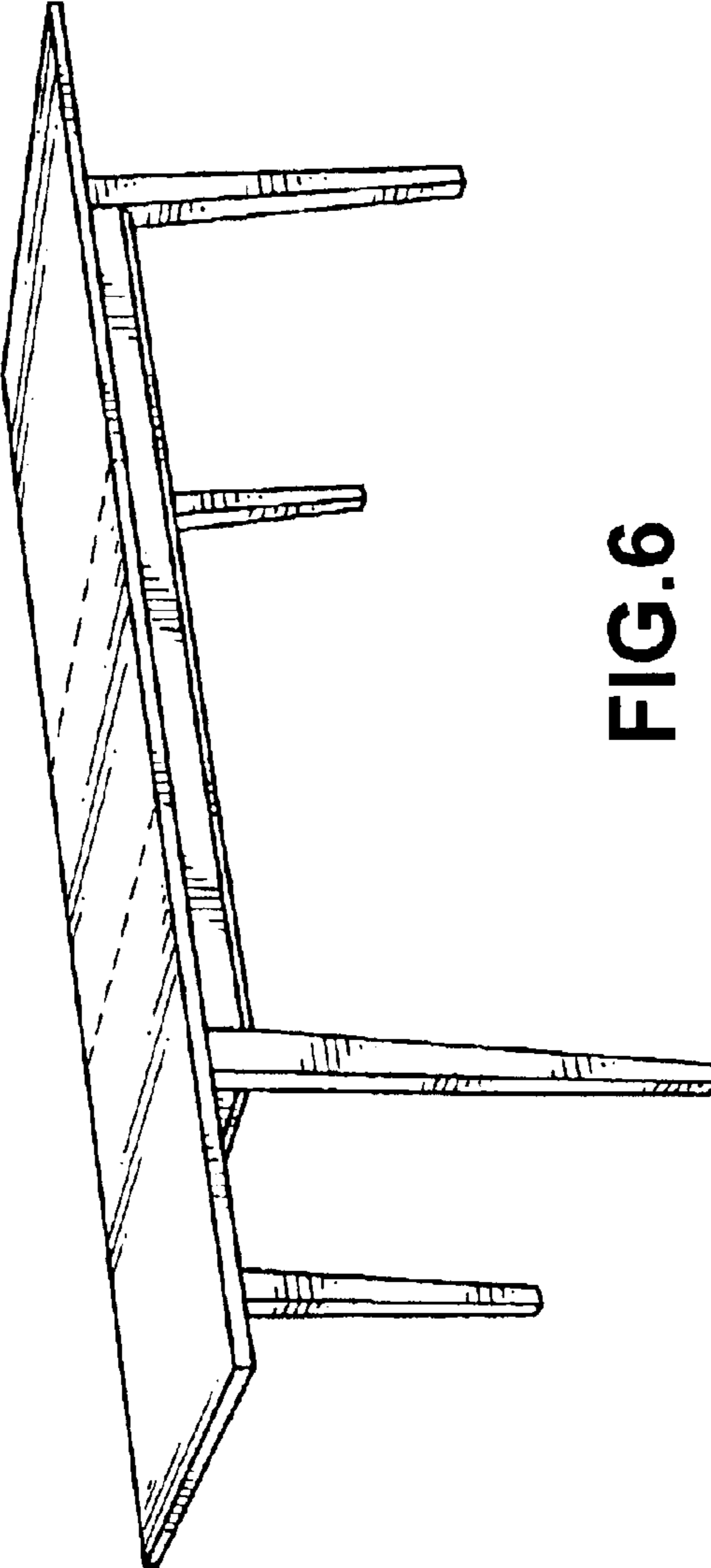

FIG.6

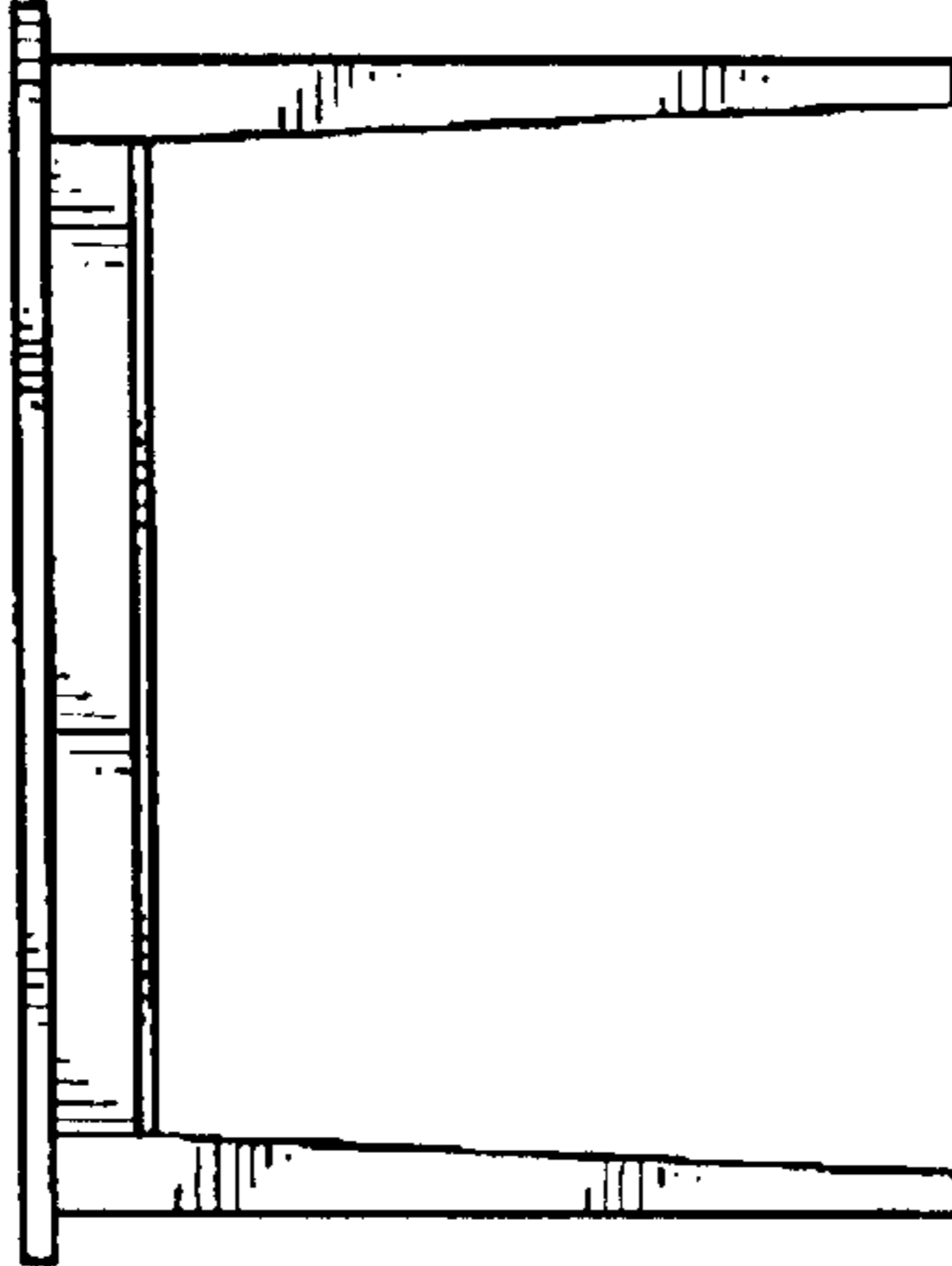

FIG. 8

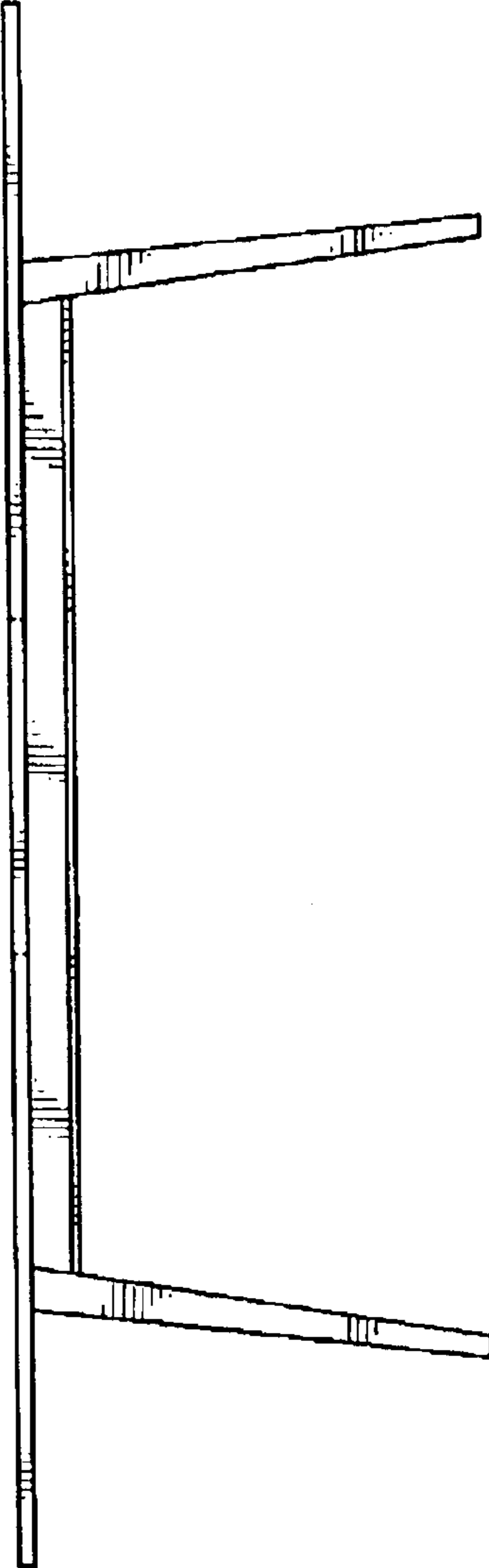
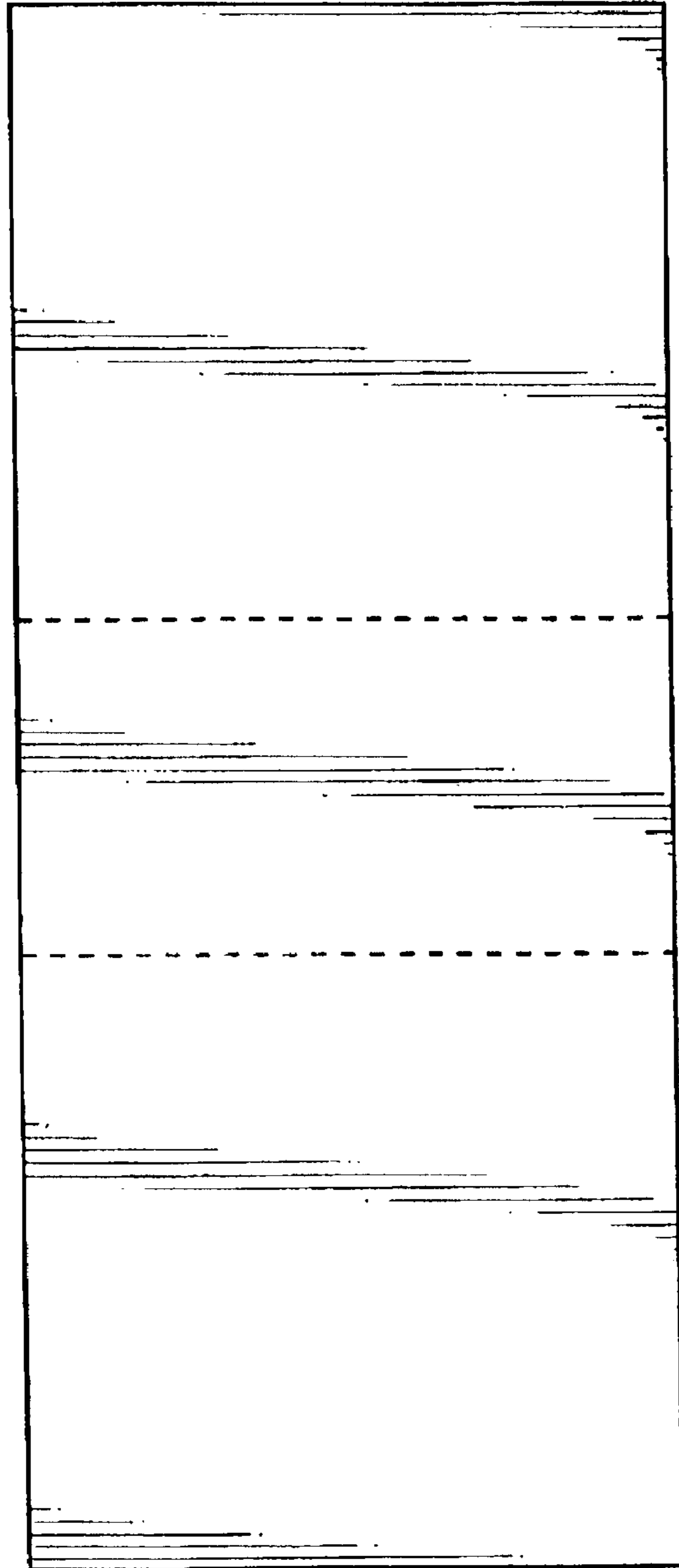

FIG. 7



**FIG. 9**



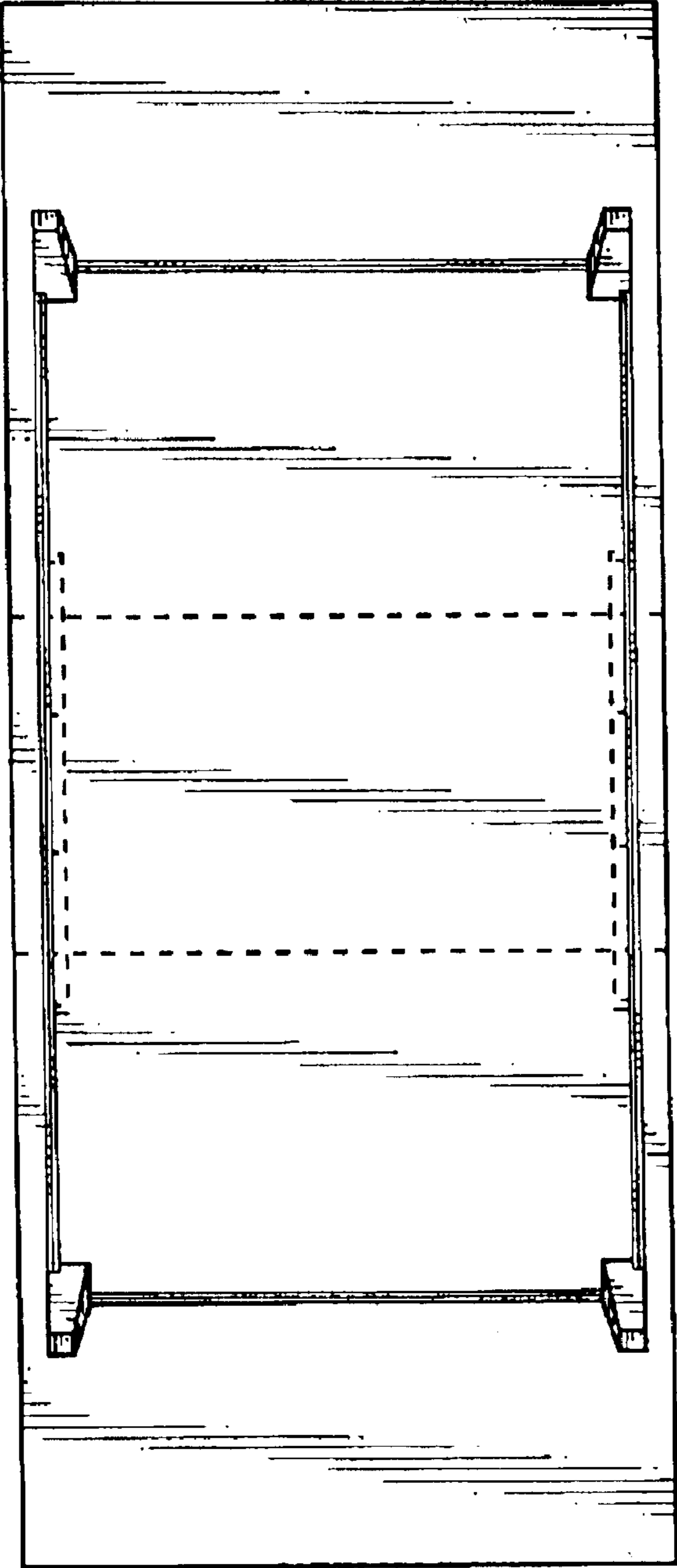

FIG.10