

US00D503254S

(12) **United States Design Patent**
Whiteside

(10) **Patent No.:** **US D503,254 S**
(45) **Date of Patent:** **** Mar. 22, 2005**

(54) **SET OF WHEELS FOR A CREEPER**

(75) Inventor: **Kirt E. Whiteside**, Marion, OH (US)

(73) Assignee: **Whiteside Mfg. Co.**, Delaware, OH (US)

(**) Term: **14 Years**

(21) Appl. No.: **29/189,406**

(22) Filed: **Sep. 4, 2003**

(51) **LOC (7) Cl.** **12-02**

(52) **U.S. Cl.** **D34/27**

(58) **Field of Search** D34/23, 27; 16/18 CG, 16/45; 280/33.991, 33.992, 33.993, 33.994, 47.18, 47.26, 47.34

(56) **References Cited**

U.S. PATENT DOCUMENTS

D313,099 S	*	12/1990	Tasley	D34/17
D398,433 S		9/1998	Whiteside et al.	D34/23
D401,029 S	*	11/1998	Taylor	D34/23
D457,810 S	*	5/2002	Chi	D8/375
D458,432 S	*	6/2002	Whiteside et al.	D34/23

OTHER PUBLICATIONS

Payson Castors catalog, p. 30, caster located at bottom of page Apr. 9, 1986.*

“Whiteside Catalog 93,” by Whiteside Manufacturing Company, Delaware, Ohio, 4 pages (1993).

* cited by examiner

Primary Examiner—Holly Baynham

(74) *Attorney, Agent, or Firm*—Renner, Kenner, Greive, Bobak, Taylor & Weber

(57) **CLAIM**

The ornamental design for a set of wheels for a creeper, as shown and described.

DESCRIPTION

FIG. 1 is a perspective view of a set of wheels for a creeper showing my new design;

FIG. 2 is a left side elevational view thereof, the right side being a mirror image of FIG. 2;

FIG. 3 is a front elevational view thereof;

FIG. 4 is a rear elevational view thereof;

FIG. 5 is a top plan view thereof; and,

FIG. 6 is a bottom plan view thereof.

The broken line showing of a creeper is for illustrative purposes only and forms no part of the claimed design.

1 Claim, 4 Drawing Sheets

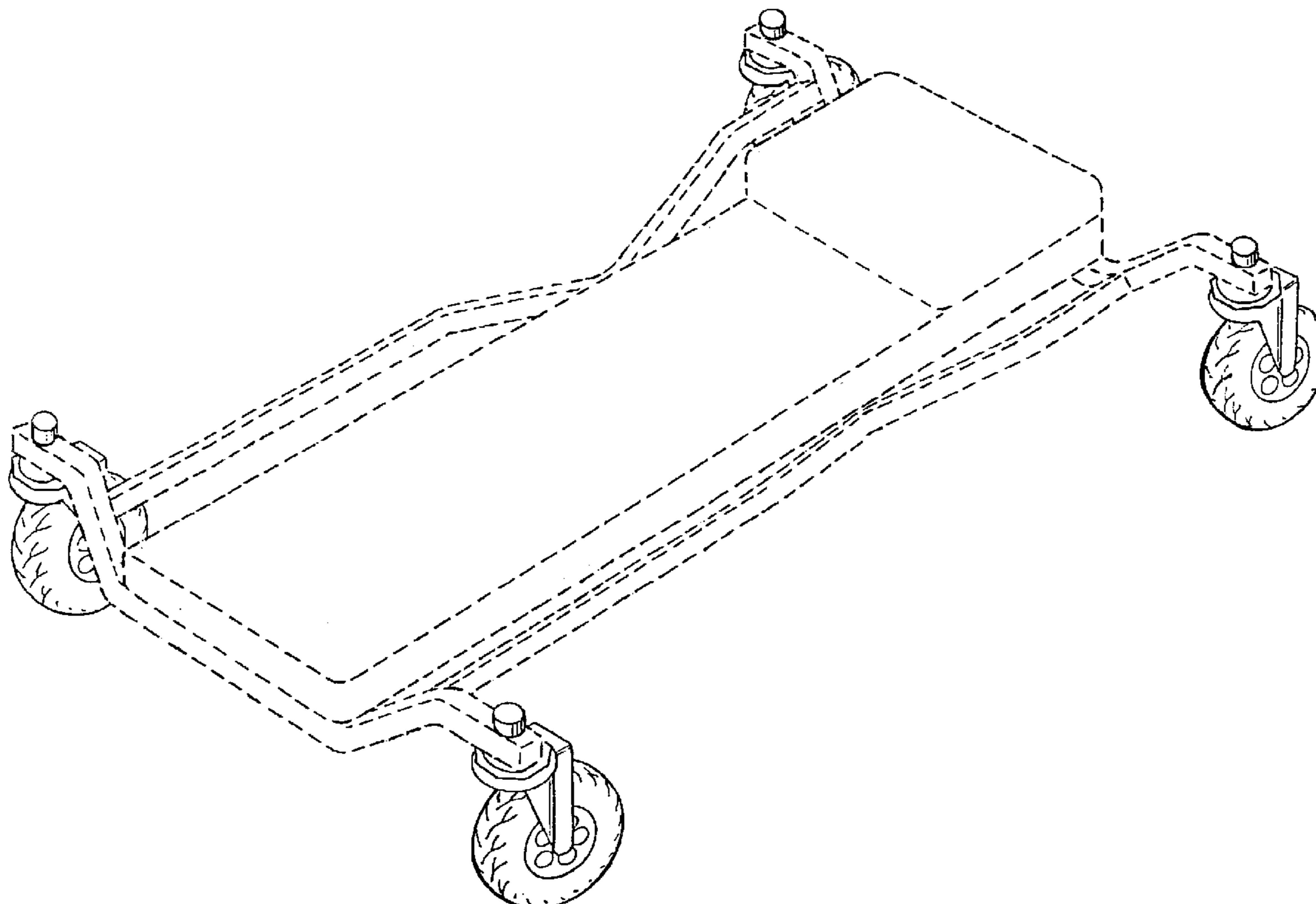

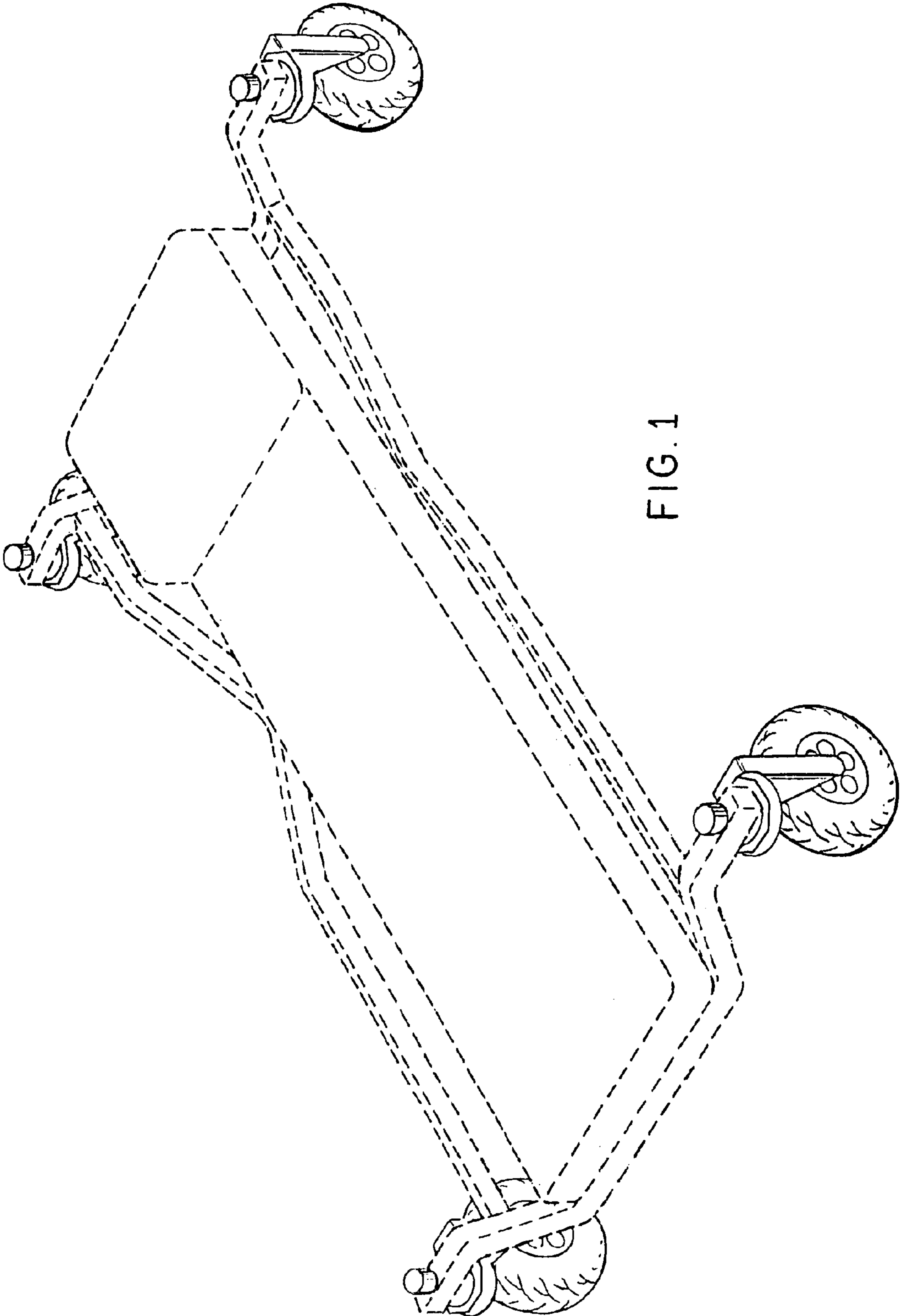

FIG. 1

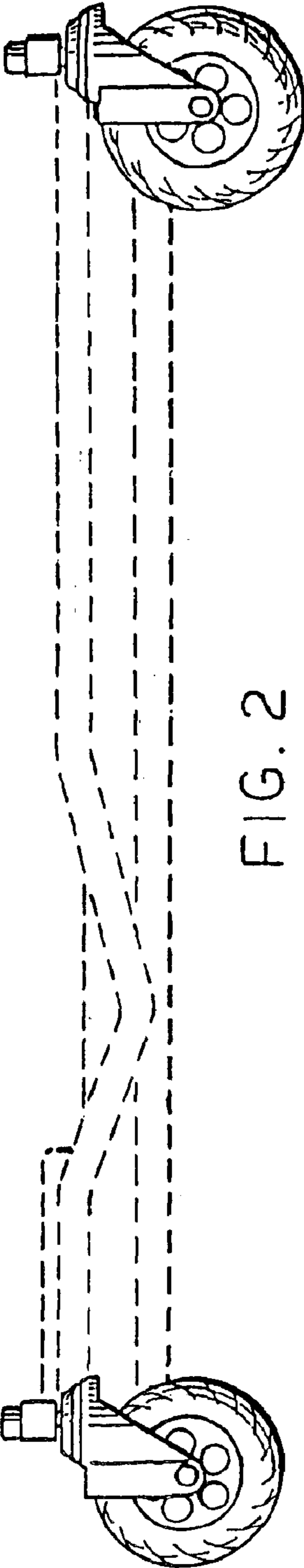

FIG. 2

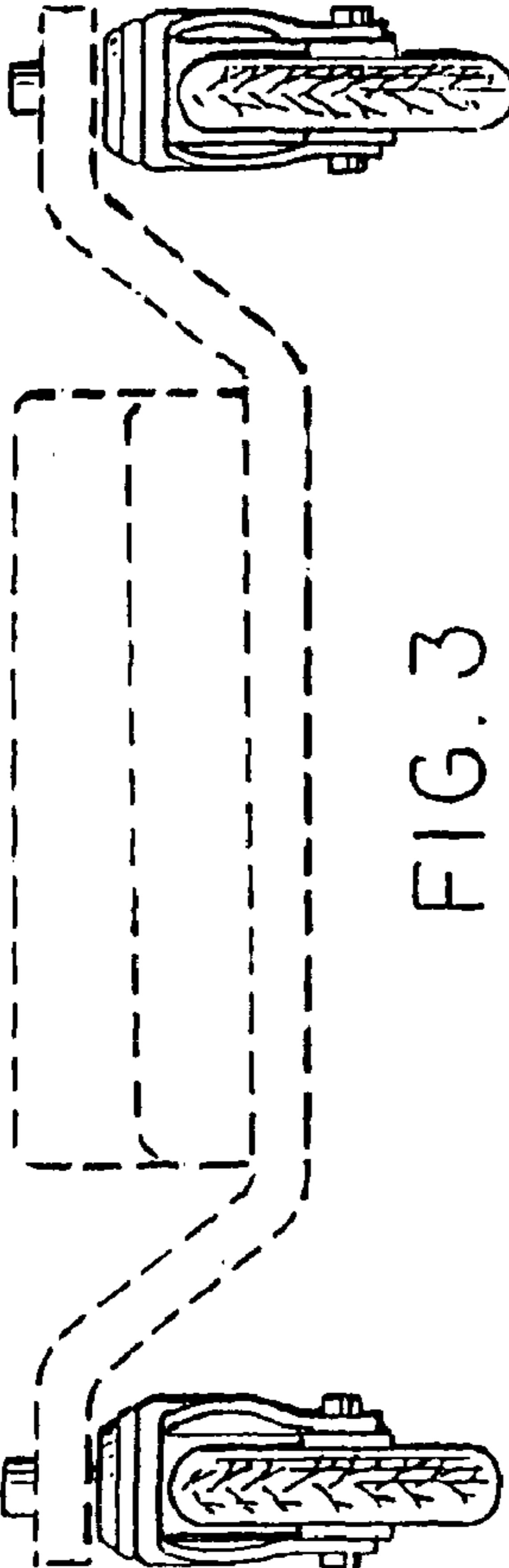

FIG. 3

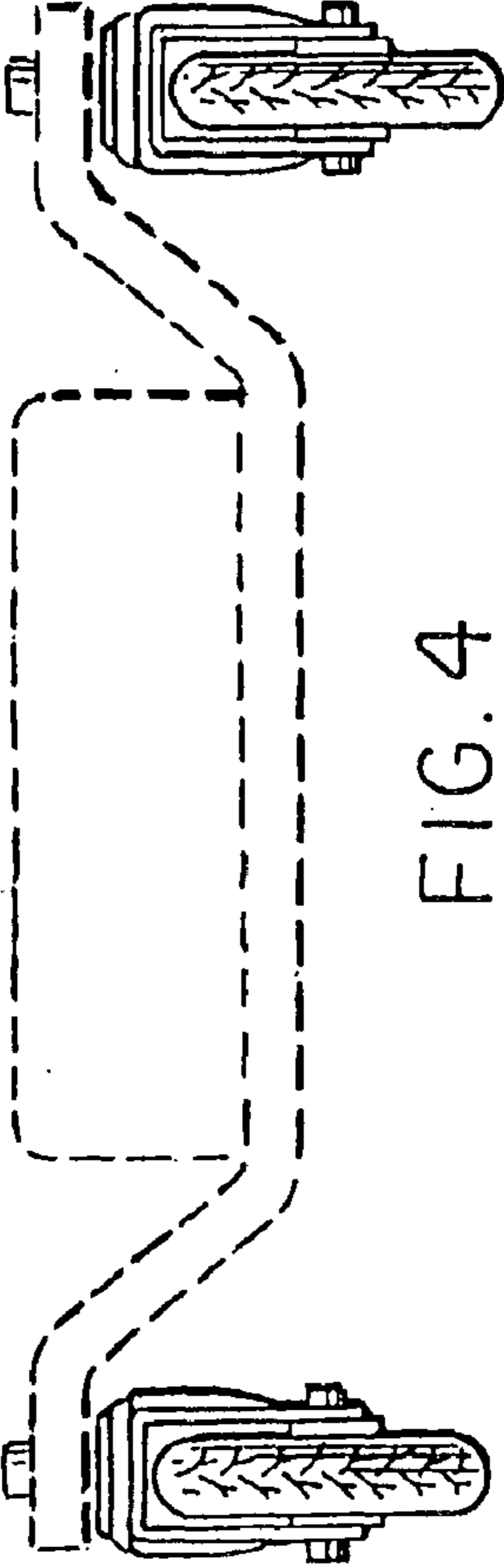

FIG. 4

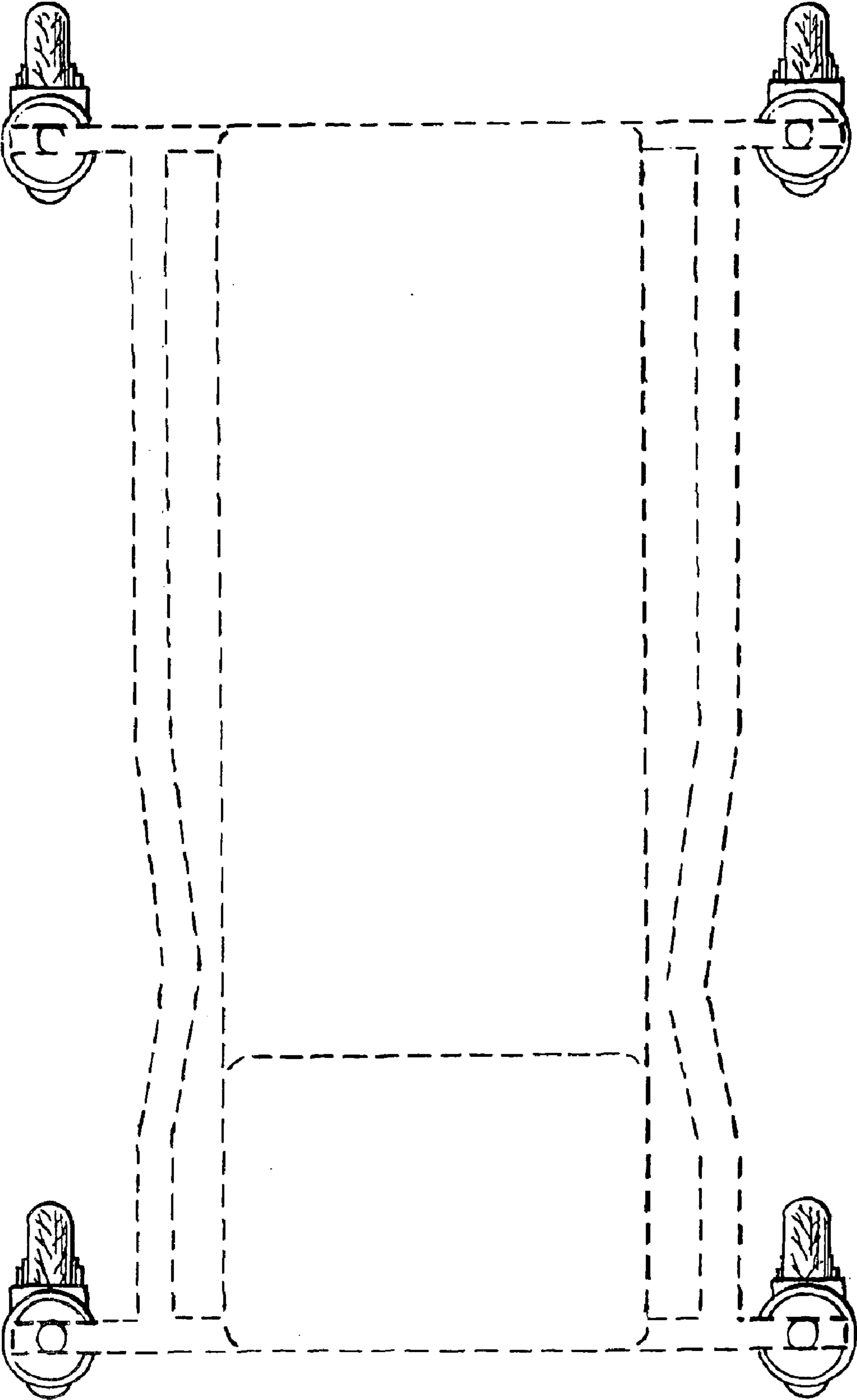

FIG. 5

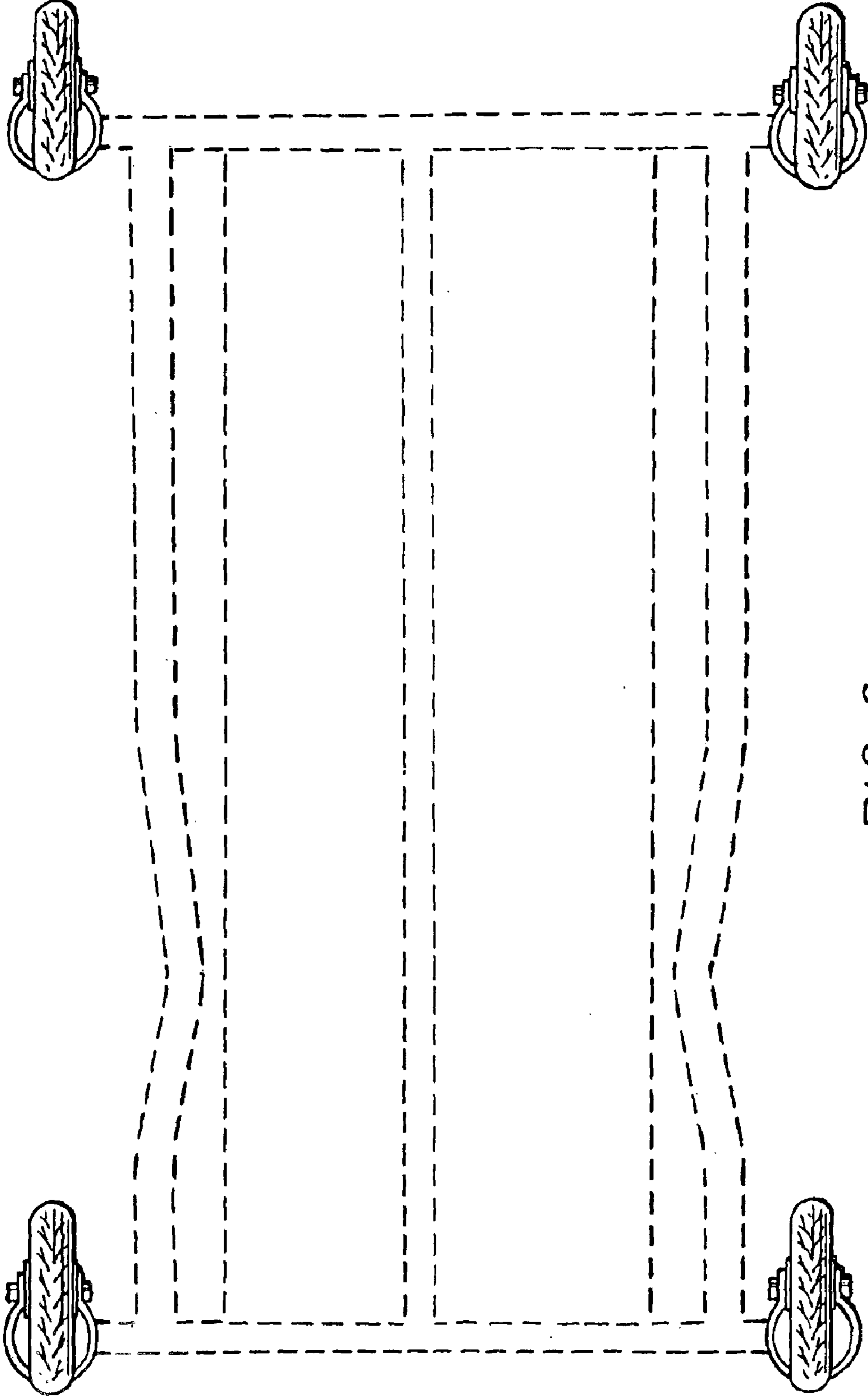

FIG. 6