

US00D503192S

(12) **United States Design Patent**  
**Hattori et al.**

(10) **Patent No.: US D503,192 S**  
(45) **Date of Patent: \*\* Mar. 22, 2005**

(54) **TAPE PRINTING MACHINE**  
(75) Inventors: **Satoru Hattori**, Nagoya (JP);  
**Toshihiro Takahashi**, Nagoya (JP)

5,492,429 A \* 2/1996 Hodges ..... 403/372  
D373,785 S \* 9/1996 Watanabe et al. .... D18/19  
D389,510 S \* 1/1998 Mimoto ..... D18/19  
D462,378 S \* 9/2002 Hattori ..... D18/19  
D491,218 S \* 6/2004 Masamitsu et al. .... D18/50

(73) Assignee: **Brother Industries, Ltd.**, Nagoya (JP)  
(\*\*) Term: **14 Years**

\* cited by examiner  
*Primary Examiner*—Charles A. Rademaker  
(74) *Attorney, Agent, or Firm*—Oliff & Berridge, PLC

(21) Appl. No.: **29/202,229**  
(22) Filed: **Mar. 29, 2004**

(57) **CLAIM**

(30) **Foreign Application Priority Data**

Sep. 29, 2003 (JP) ..... 2003-028402

The ornamental design for tape printing machine, as shown and described.

(51) **LOC (7) Cl.** ..... **18-02**  
(52) **U.S. Cl.** ..... **D18/56**  
(58) **Field of Search** ..... D18/50, 19, 56,  
D18/36-39; D14/686, 692, 613; 400/613,  
613.1-613.4, 691-694, 690.1-690.4; 355/78;  
101/93.4, 269

**DESCRIPTION**

FIG. 1 is a front view of a tape printing machine;  
FIG. 2 is a top view thereof;  
FIG. 3 is a right-side view thereof;  
FIG. 4 is a left-side view thereof;  
FIG. 5 is a rear view thereof;  
FIG. 6 is a front perspective view thereof; and,  
FIG. 7 is a rear perspective view thereof.  
The broken line disclosure is for illustrative purposes only and forms no part of the claimed design.

(56) **References Cited**

**U.S. PATENT DOCUMENTS**

D315,919 S \* 4/1991 Miyamoto et al. .... D18/50  
D344,537 S \* 2/1994 Tsuchida et al. .... D18/19

**1 Claim, 4 Drawing Sheets**

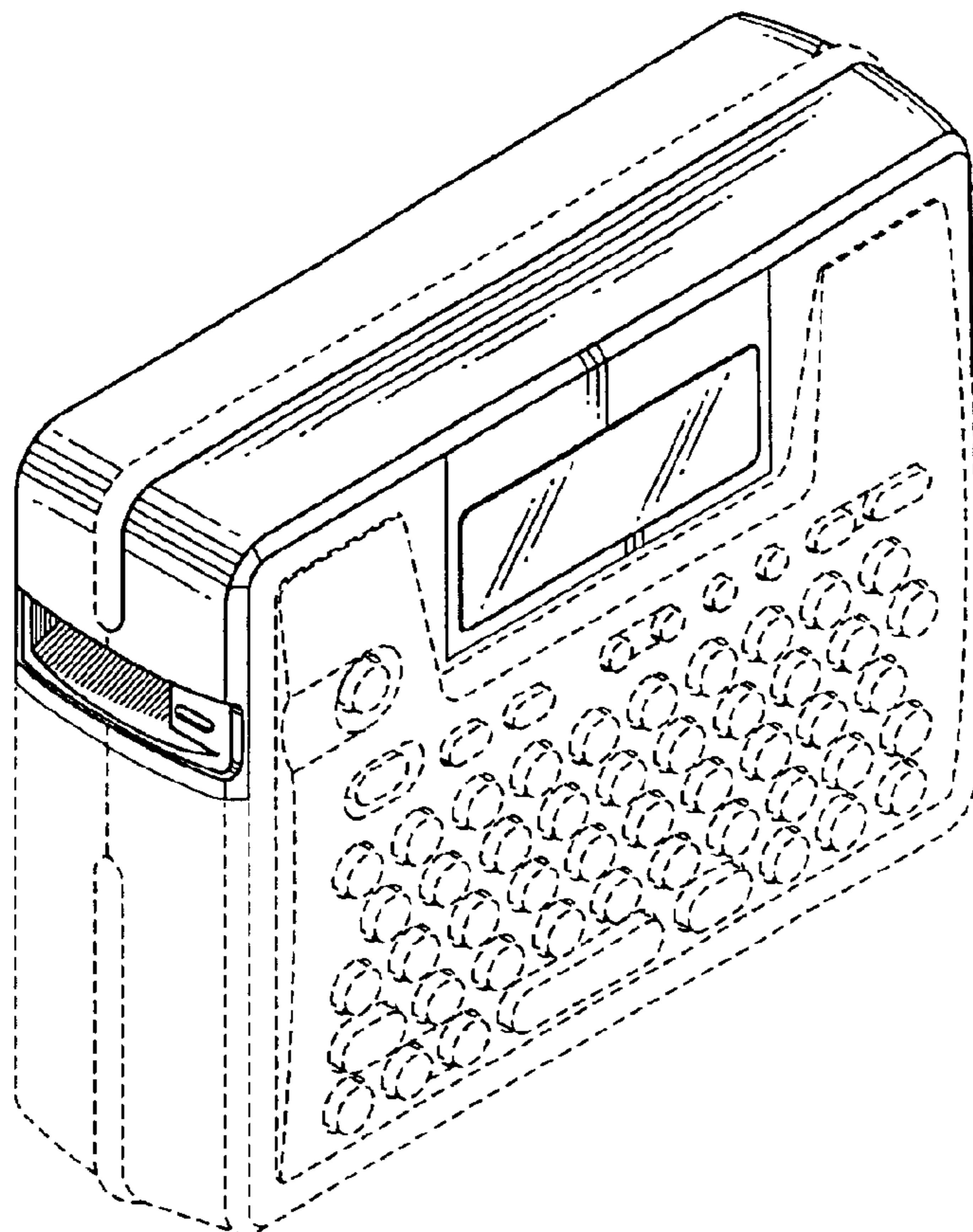

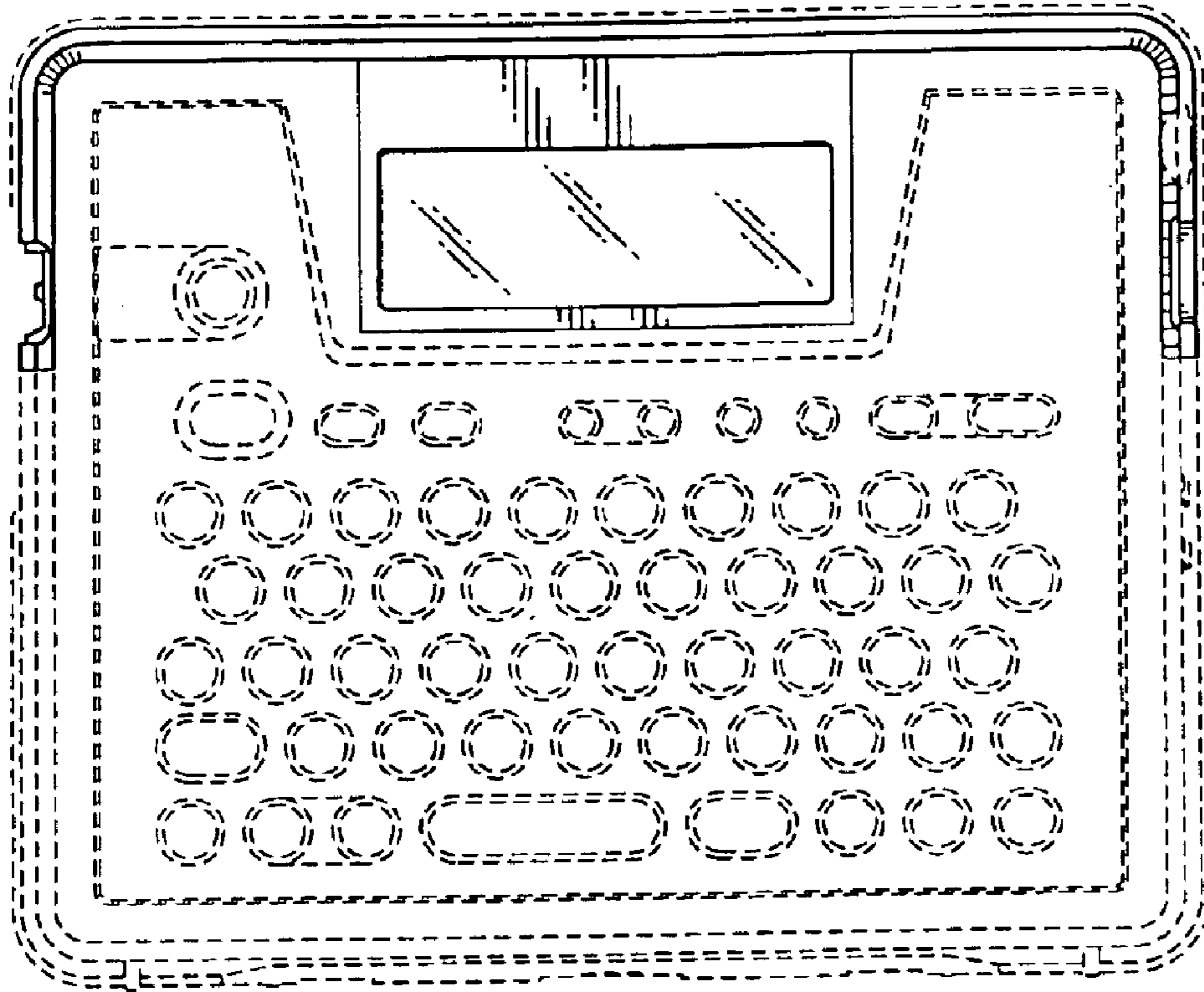

FIG. 1

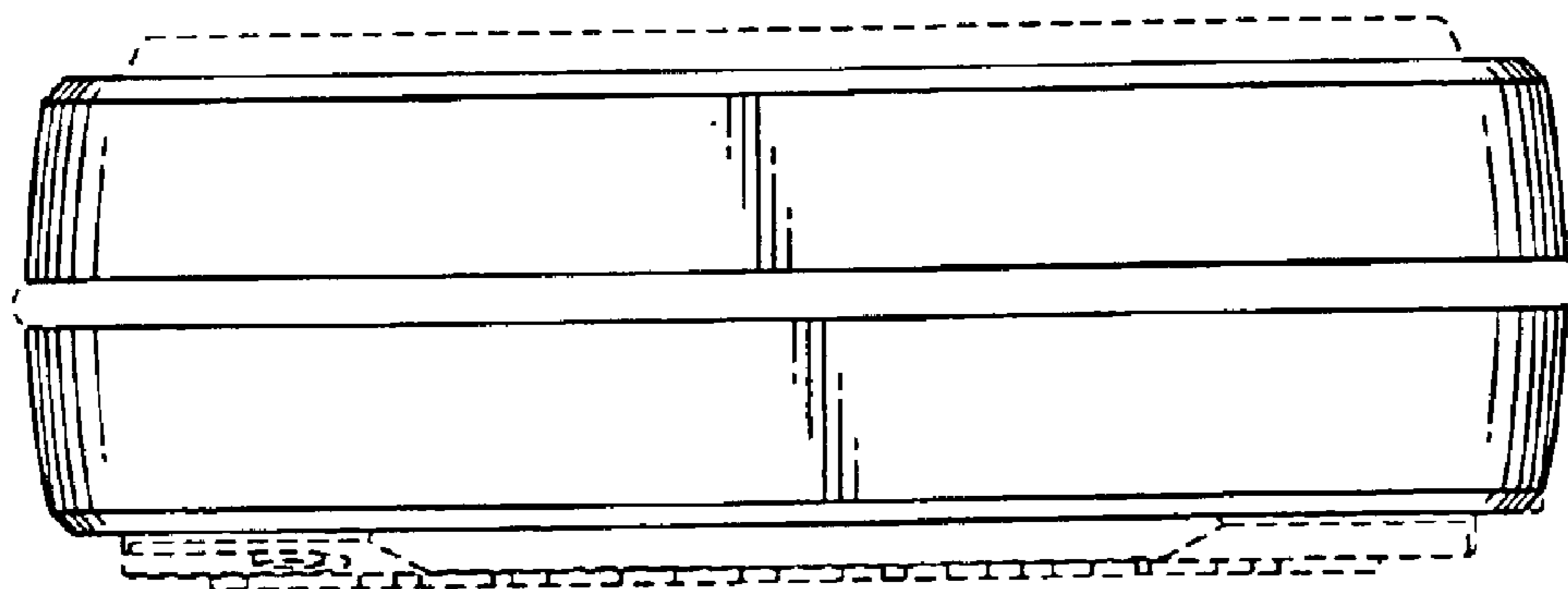

FIG. 2

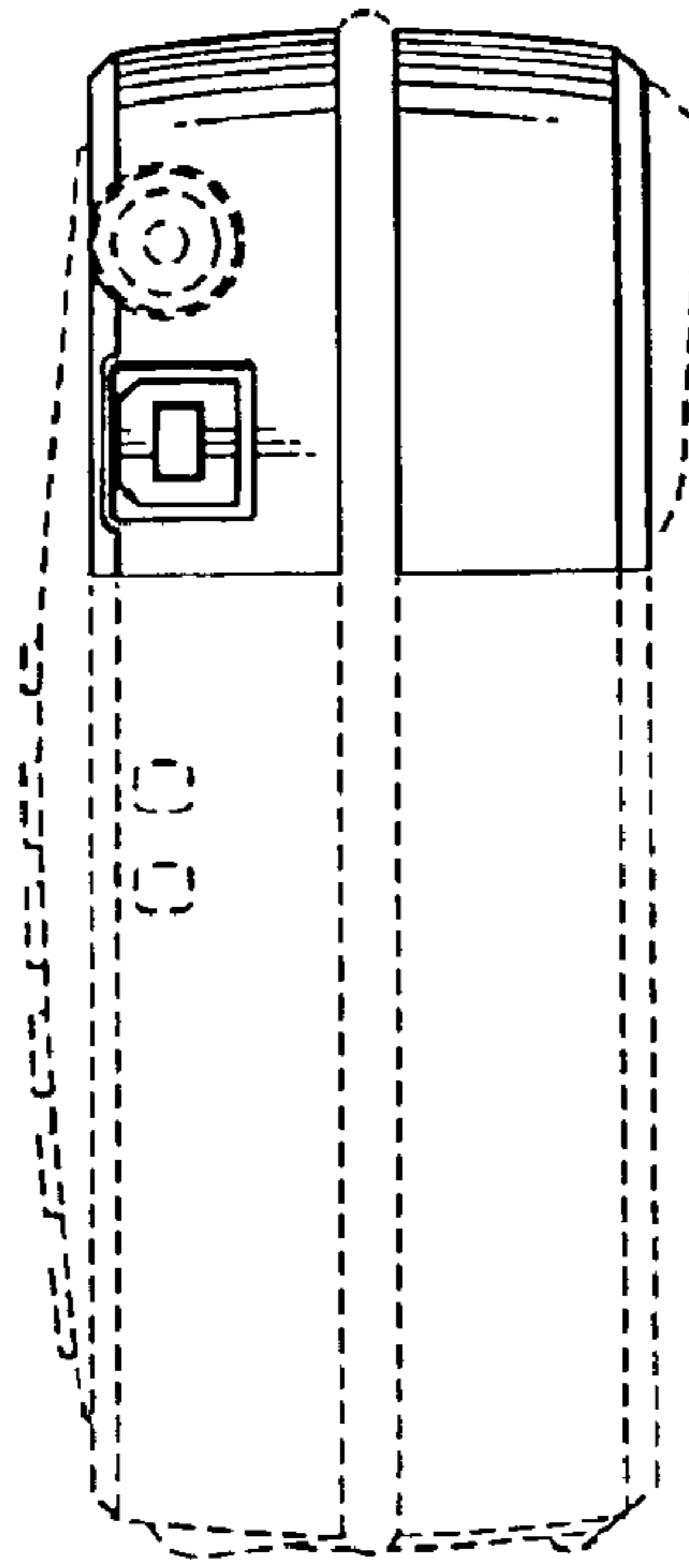

FIG. 3

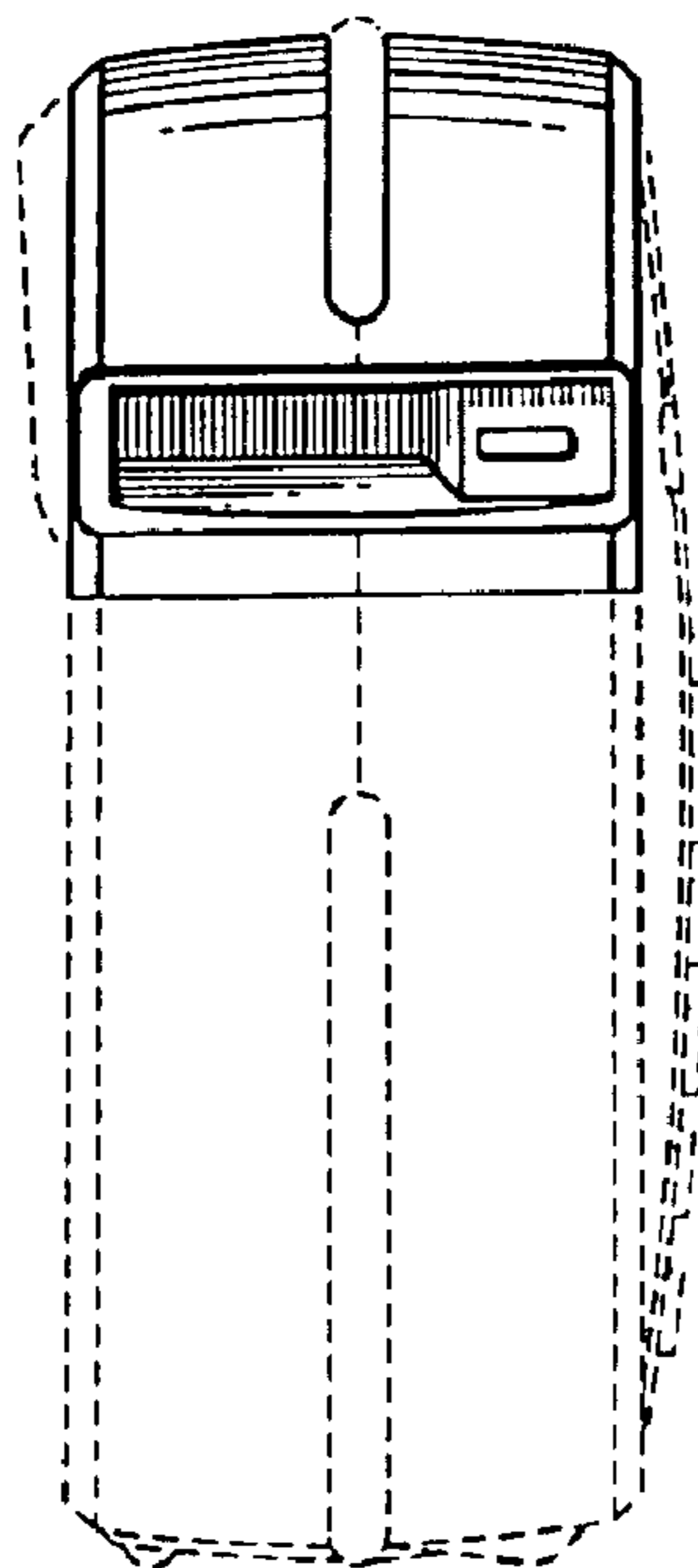

FIG. 4

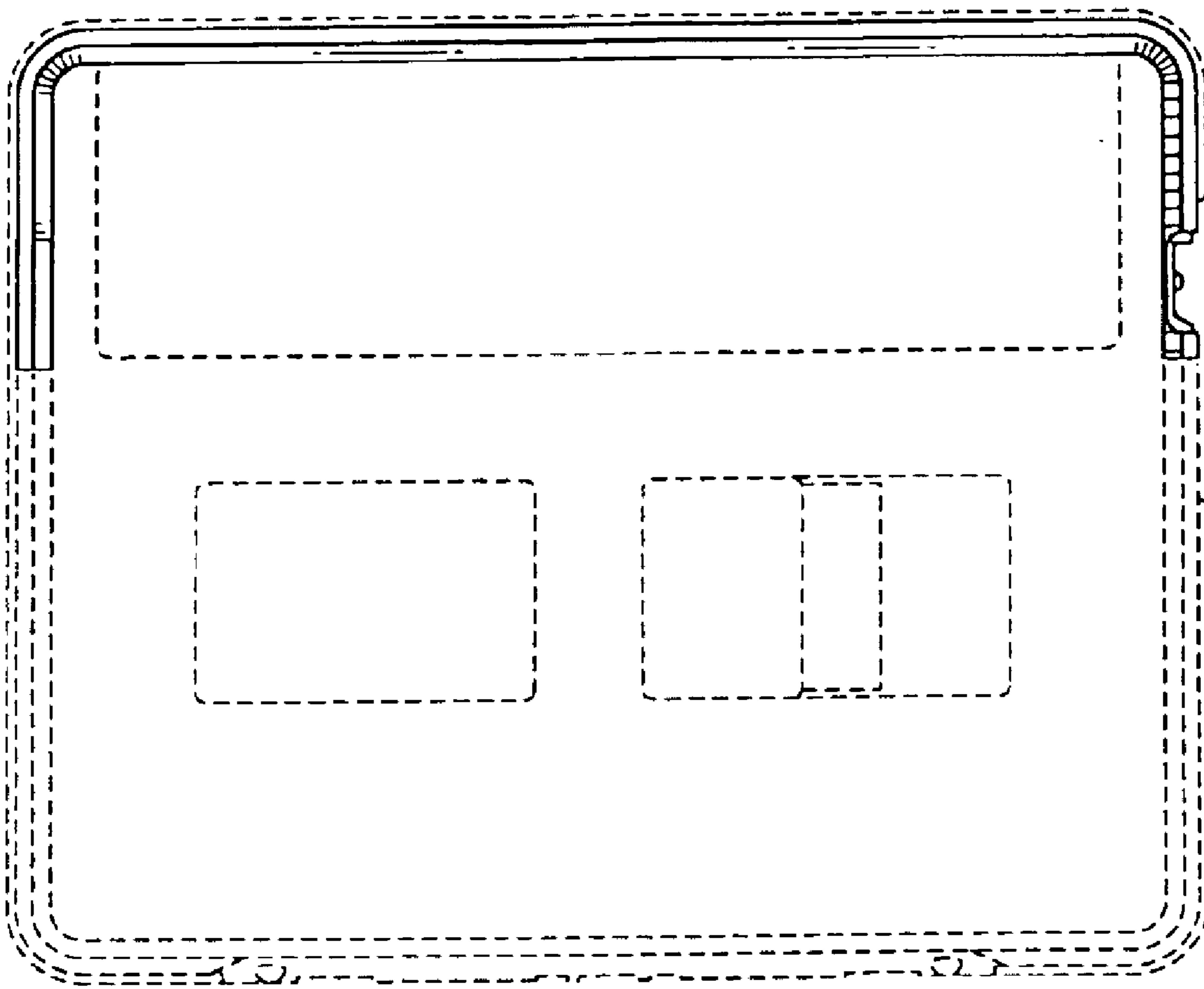

FIG. 5

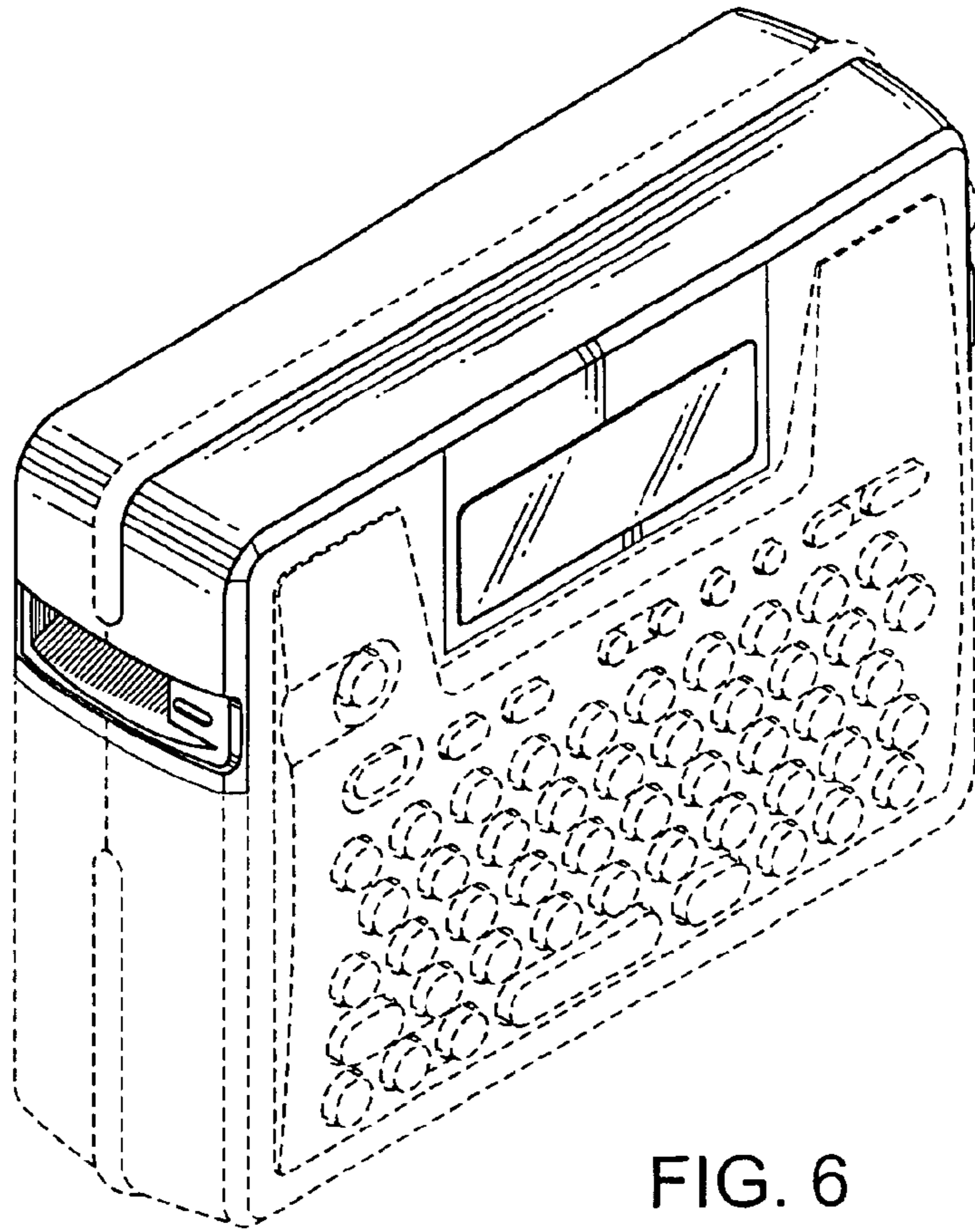

FIG. 6

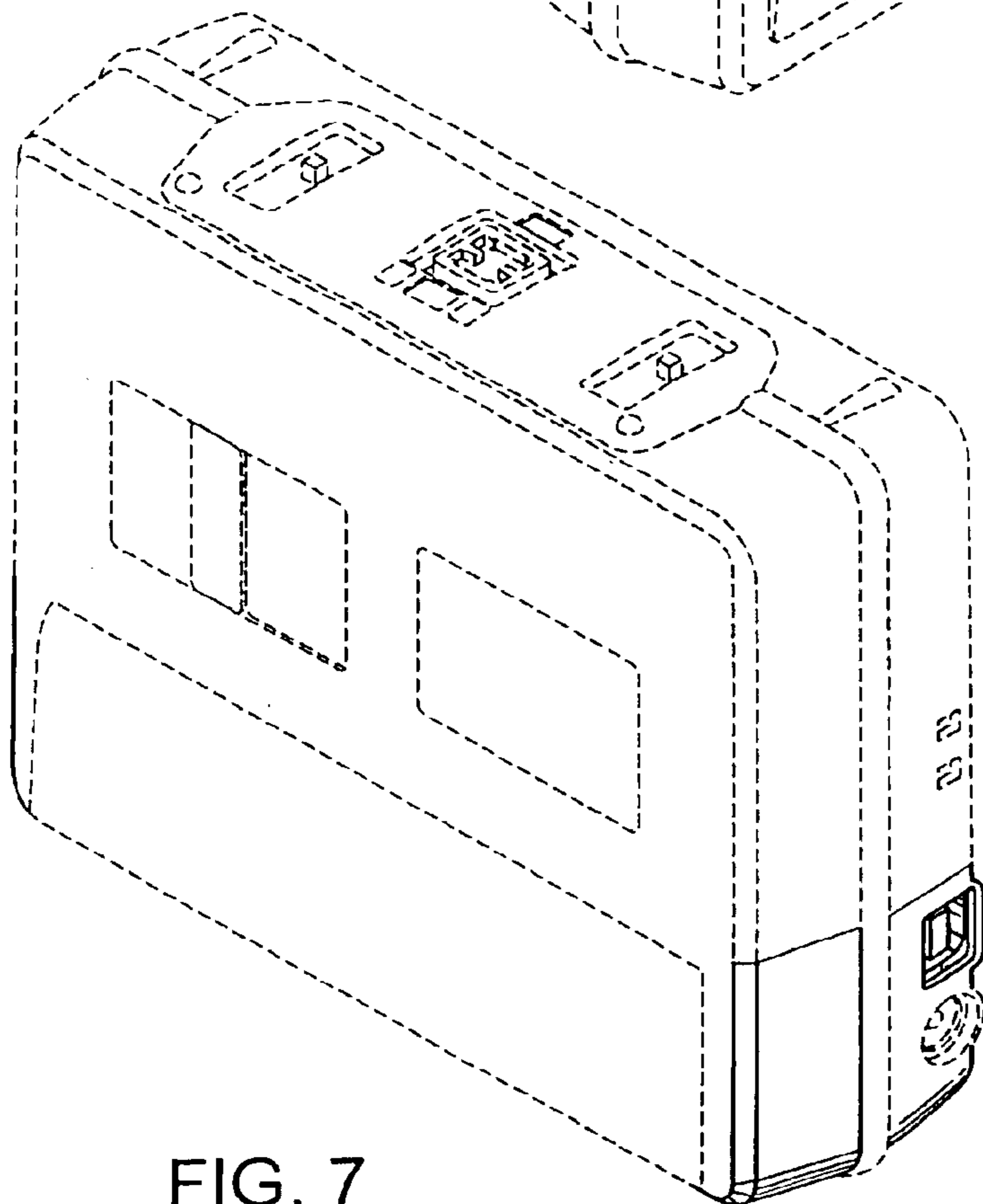

FIG. 7