

US00D503116S

(12) **United States Design Patent**
Raab et al.

(10) **Patent No.:** **US D503,116 S**
(45) **Date of Patent:** **** Mar. 22, 2005**

(54) **PORTABLE COORDINATE MEASUREMENT MACHINE PORTION**

(75) Inventors: **Simon Raab**, Maitland, FL (US); **Seyed Ali Sajedi**, Winter Park, FL (US); **Kenneth J. Hasloeher**, Deltona, FL (US); **Marc Barber**, Deltona, FL (US)

(73) Assignee: **Faro Technologies, Inc.**, Lake Mary, FL (US)

(**) Term: **14 Years**

(21) Appl. No.: **29/203,023**

(22) Filed: **Apr. 8, 2004**

Related U.S. Application Data

(60) Division of application No. 29/186,985, filed on Jul. 24, 2003, now Pat. No. Des. 497,815, which is a continuation-in-part of application No. 29/175,956, filed on Feb. 13, 2003, now Pat. No. Des. 491,589, which is a continuation-in-part of application No. 29/166,332, filed on Aug. 26, 2002, now Pat. No. Des. 479,544, which is a continuation-in-part of application No. 29/155,790, filed on Feb. 14, 2002, now Pat. No. Des. 472,824.

(51) **LOC (7) Cl.** **10-04**

(52) **U.S. Cl.** **D10/63; D15/199**

(58) **Field of Search** **D10/46, 63; D15/199; 33/503-505, 558; 74/490.01-490.15; 319/560; 700/245, 262, 195, 80; 702/150-156, 94-95, 167-169**

(56) **References Cited**

U.S. PATENT DOCUMENTS

4,766,775 A * 8/1988 Hodge 74/490.01

4,805,477 A * 2/1989 Akeel 74/490.05
4,911,033 A * 3/1990 Rosheim et al. 74/490.03
5,036,724 A * 8/1991 Rosheim 74/490.06
D423,534 S * 4/2000 Raab et al. D15/199
6,131,299 A * 10/2000 Raab et al. 33/503
6,151,789 A * 11/2000 Raab et al. 33/503
6,298,569 B1 * 10/2001 Raab et al. 33/503
D472,824 S * 4/2003 Raab et al. D10/63
6,606,539 B2 * 8/2003 Raab 33/503
D479,544 S * 9/2003 Raab et al. D15/199
D490,831 S * 6/2004 Raab et al. D15/199
D491,589 S * 6/2004 Raab et al. D15/199
D491,965 S * 6/2004 Raab et al. D15/199

* cited by examiner

Primary Examiner—Antoine D. Davis

(74) *Attorney, Agent, or Firm*—Cantor Colburn LLP

(57) **CLAIM**

The ornamental design for a portable coordinate measurement machine portion, as shown and described.

DESCRIPTION

FIG. 1 is a front perspective view of our new portable coordinate measurement machine portion including items in broken lines which are used herein and throughout the several figures for illustrative purposes only and form no part of the claimed design;

FIG. 2 is a front view thereof;

FIG. 3 is a rear view thereof;

FIG. 4 is a side view thereof with the opposite side view being a mirror image thereof;

FIG. 5 is a top view thereof; and,

FIG. 6 is a bottom view thereof.

1 Claim, 4 Drawing Sheets

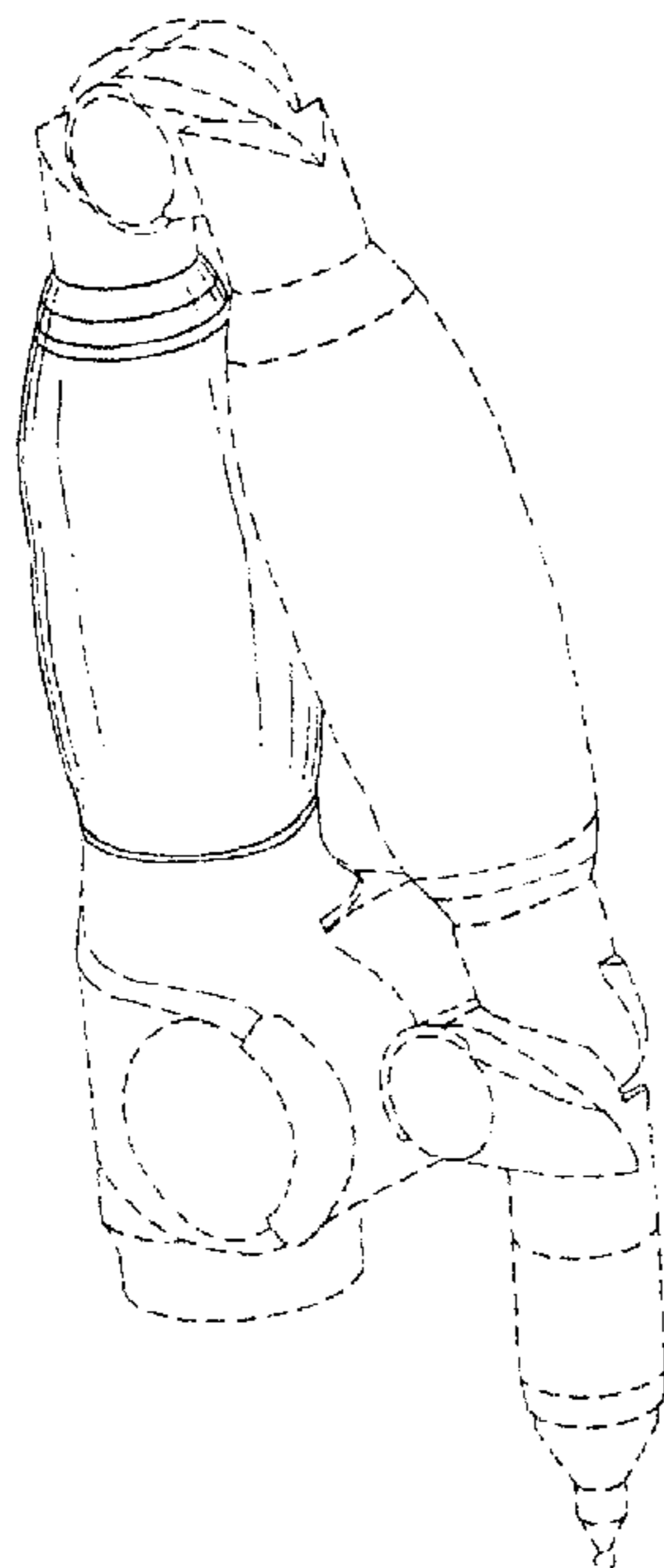

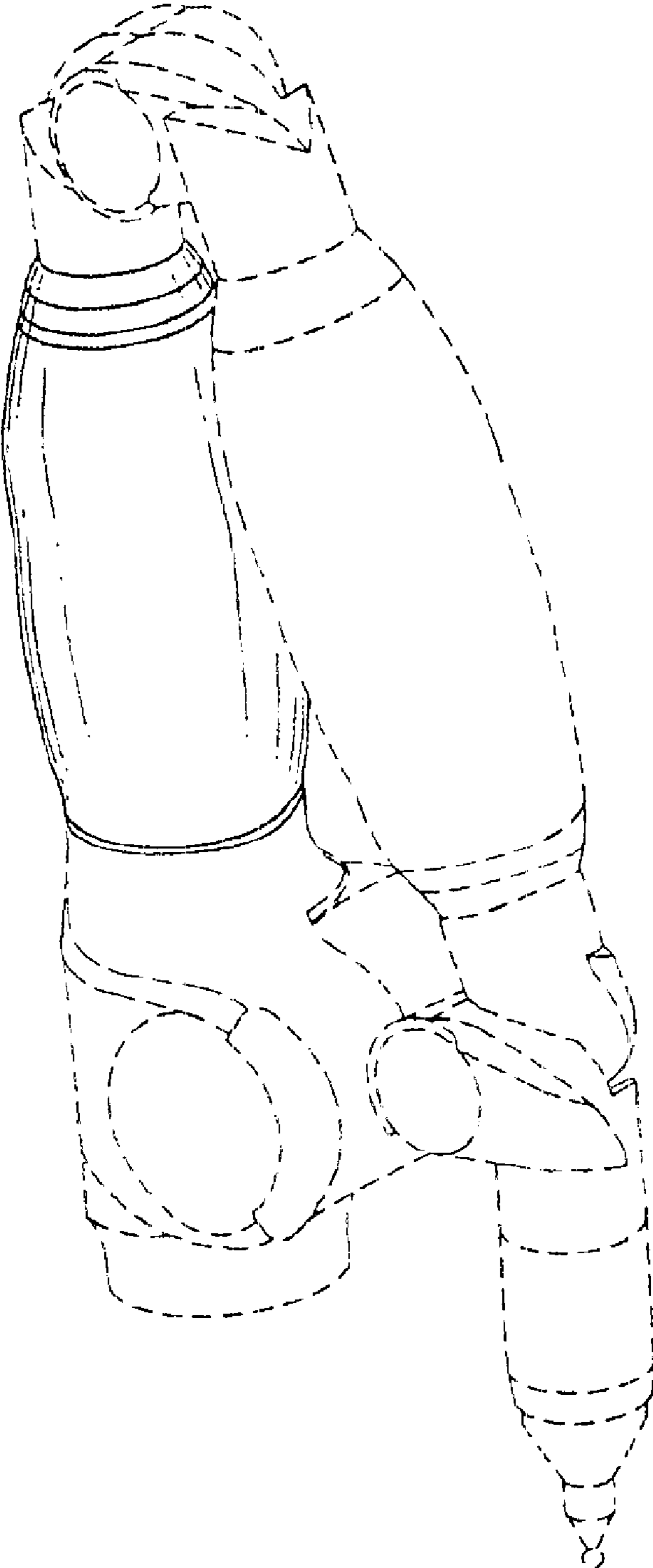

FIGURE 1

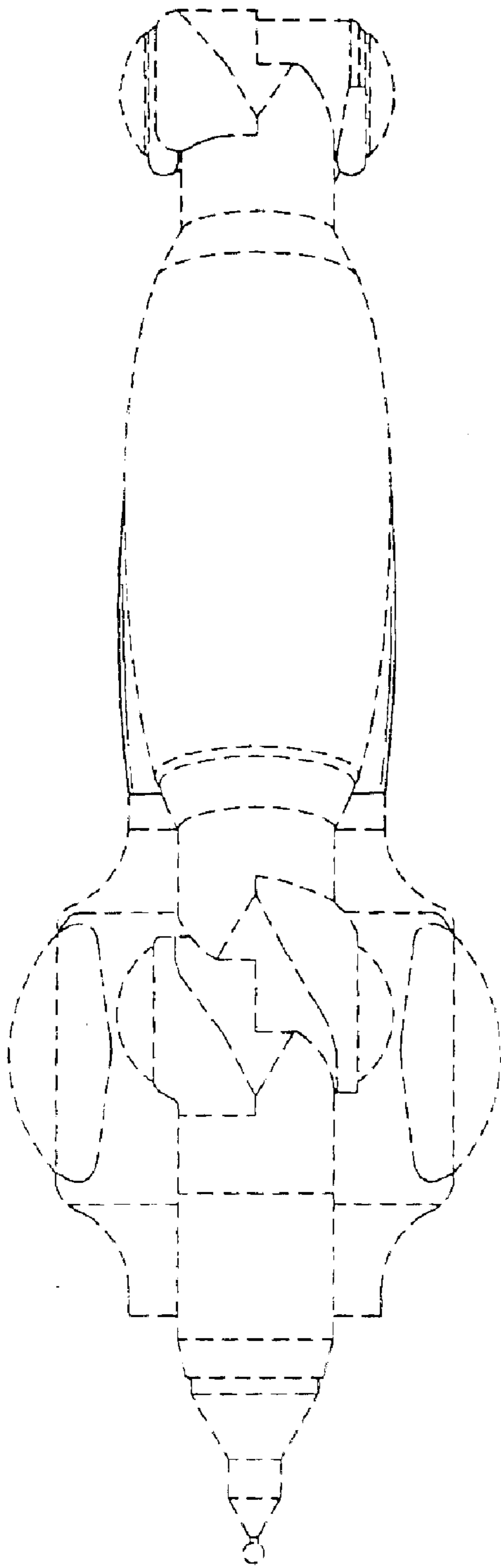

FIGURE 2

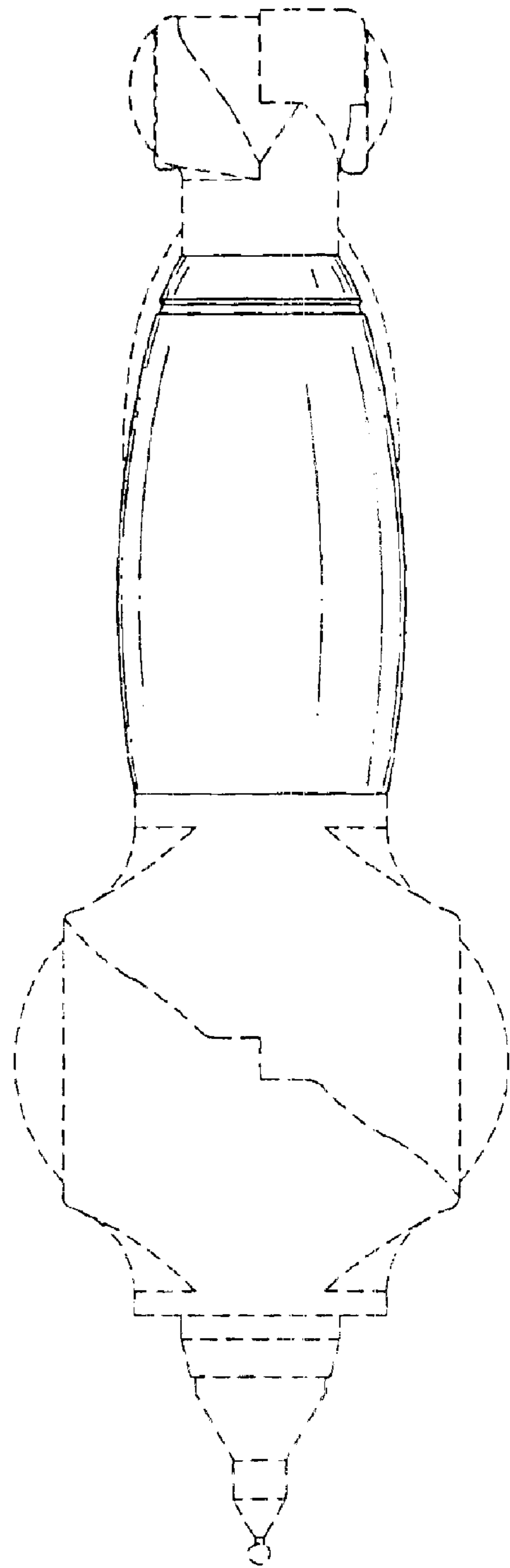

FIGURE 3

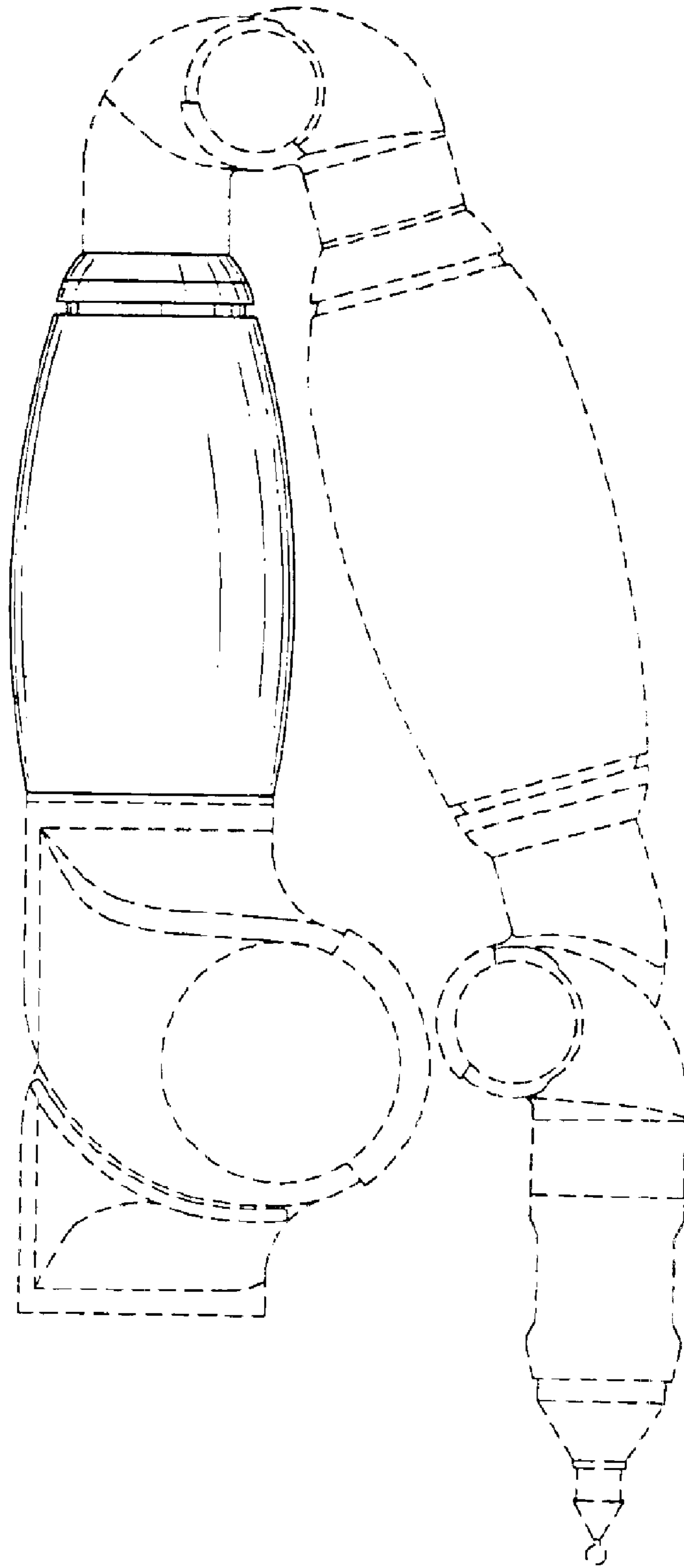

FIGURE 4

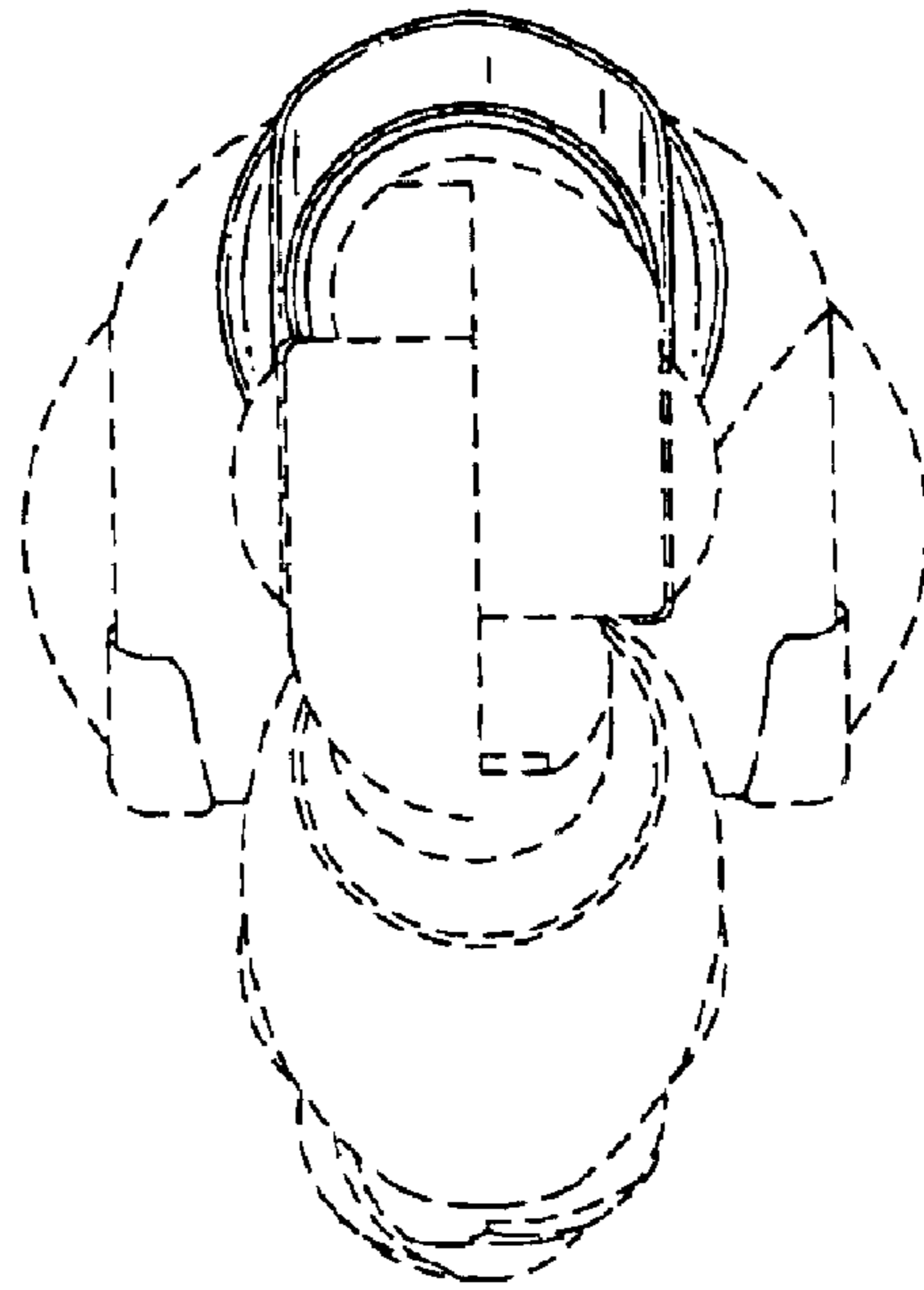

FIGURE 5

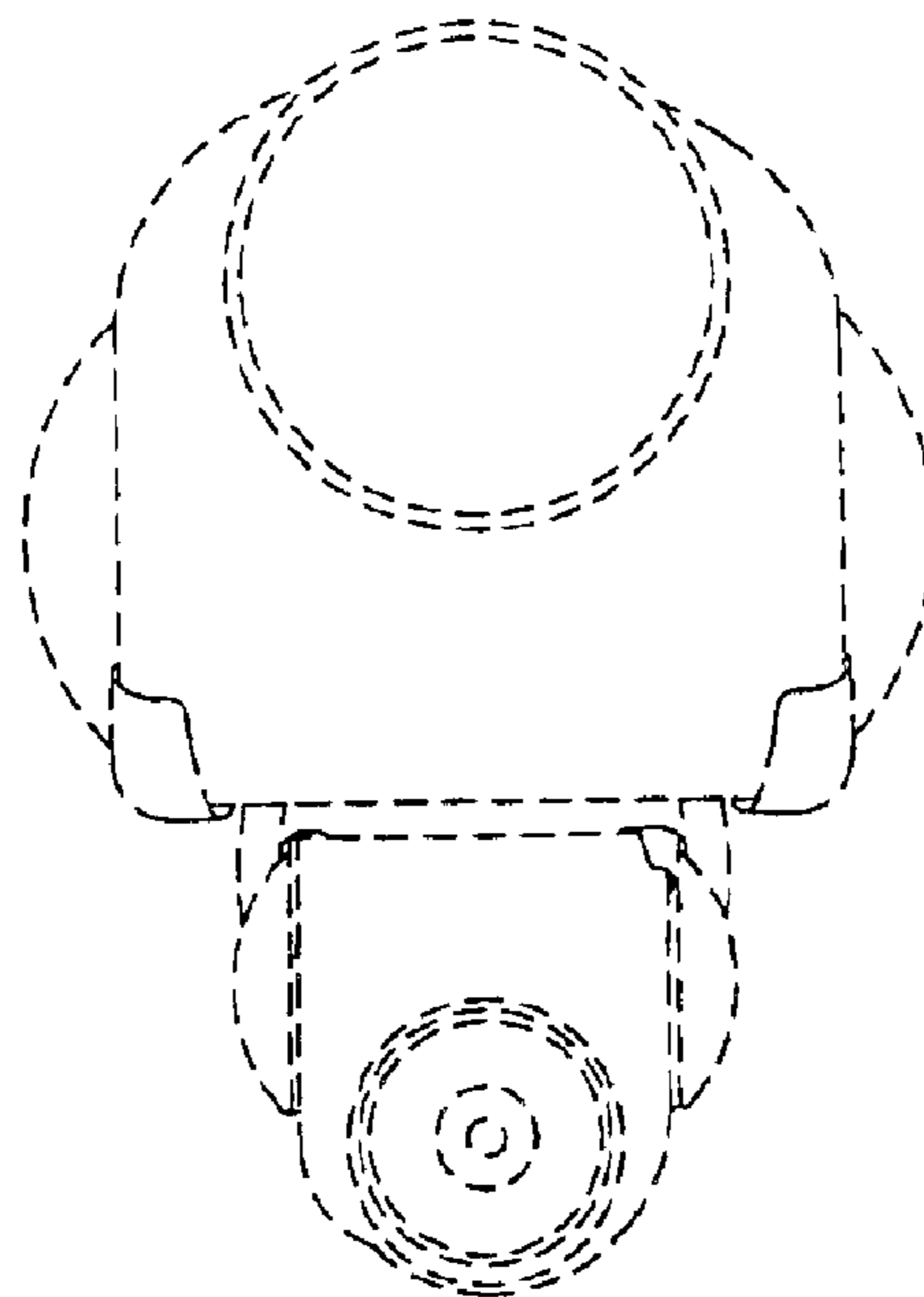

FIGURE 6