



US00D503039S

(12) **United States Design Patent** (10) **Patent No.:** **US D503,039 S**
Cook et al. (45) **Date of Patent:** **** Mar. 22, 2005**

(54) **FLASHLIGHT HOLSTER**

(75) Inventors: **Clifton L. Cook**, Boise, ID (US);
Thomas M. Gregory, Belgrade, MT
(US); **Robert A. Kincaid**, Bozeman,
MT (US); **Eric M. Yeates**, Boise, ID
(US)

(73) Assignee: **Blackhawk Industries Product Group
Unlimited LLC**, Norfolk, VA (US)

(**) Term: **14 Years**

(21) Appl. No.: **29/199,057**

(22) Filed: **Feb. 9, 2004**

(51) **LOC (7) Cl.** **03-01**

(52) **U.S. Cl.** **D3/229; D3/215**

(58) **Field of Search** **D3/229, 228, 215,**
D3/207-212; D26/38-39; 224/914, 247,
240, 245, 251, 911

(56) **References Cited**

U.S. PATENT DOCUMENTS

5,449,104	A	*	9/1995	Parsons et al.	224/245
D374,769	S	*	10/1996	Case	D3/229
D374,770	S	*	10/1996	Case	D3/229
D381,805	S	*	8/1997	Case	D3/229
5,699,104	A	*	12/1997	Yoshinobu	224/245
5,699,943	A	*	12/1997	Schaefer et al.	224/247
6,059,157	A	*	5/2000	Parsons et al.	224/251
D450,451	S	*	11/2001	Starrett	D3/229

* cited by examiner

Primary Examiner—Catherine R. Oliver

(74) *Attorney, Agent, or Firm*—Bowman Green Hampton
& Kelly, PLLC

(57) **CLAIM**

The ornamental design for a flashlight holster, as shown and
described.

DESCRIPTION

FIG. 1 is a top perspective view of a flashlight holster
showing our new design;

FIG. 2 is a front elevation view of our flashlight holster of
FIG. 1;

FIG. 3 is a rear elevation view of our flashlight holster of
FIG. 1;

FIG. 4 is a side elevation view of our flashlight holster of
FIG. 1;

FIG. 5 is a top plan view of our flashlight holster of FIG. 1;

FIG. 6 is a bottom plan view of our flashlight holster of FIG.
1;

FIG. 7 is a front elevation view of our flashlight holster of
FIG. 1, with the clip removed from the rear of the holster;

FIG. 8 is a rear elevation view of our flashlight holster of
FIG. 7;

FIG. 9 is a cross sectional view of our flashlight holster
shown along line 9—9 of FIG. 5, it being understood that the
broken line disclosure of a flashlight is for illustrative
purposes only and forms no part of the claimed design;

FIG. 10 is a cross sectional view of our flashlight holster
shown along line 10—10 of FIG. 5, it being understood that
the broken line disclosure of a flashlight is for illustrative
purposes only and forms no part of the claimed design; and,

FIG. 11 is a rear elevation view of our flashlight holster of
FIG. 10.

1 Claim, 5 Drawing Sheets

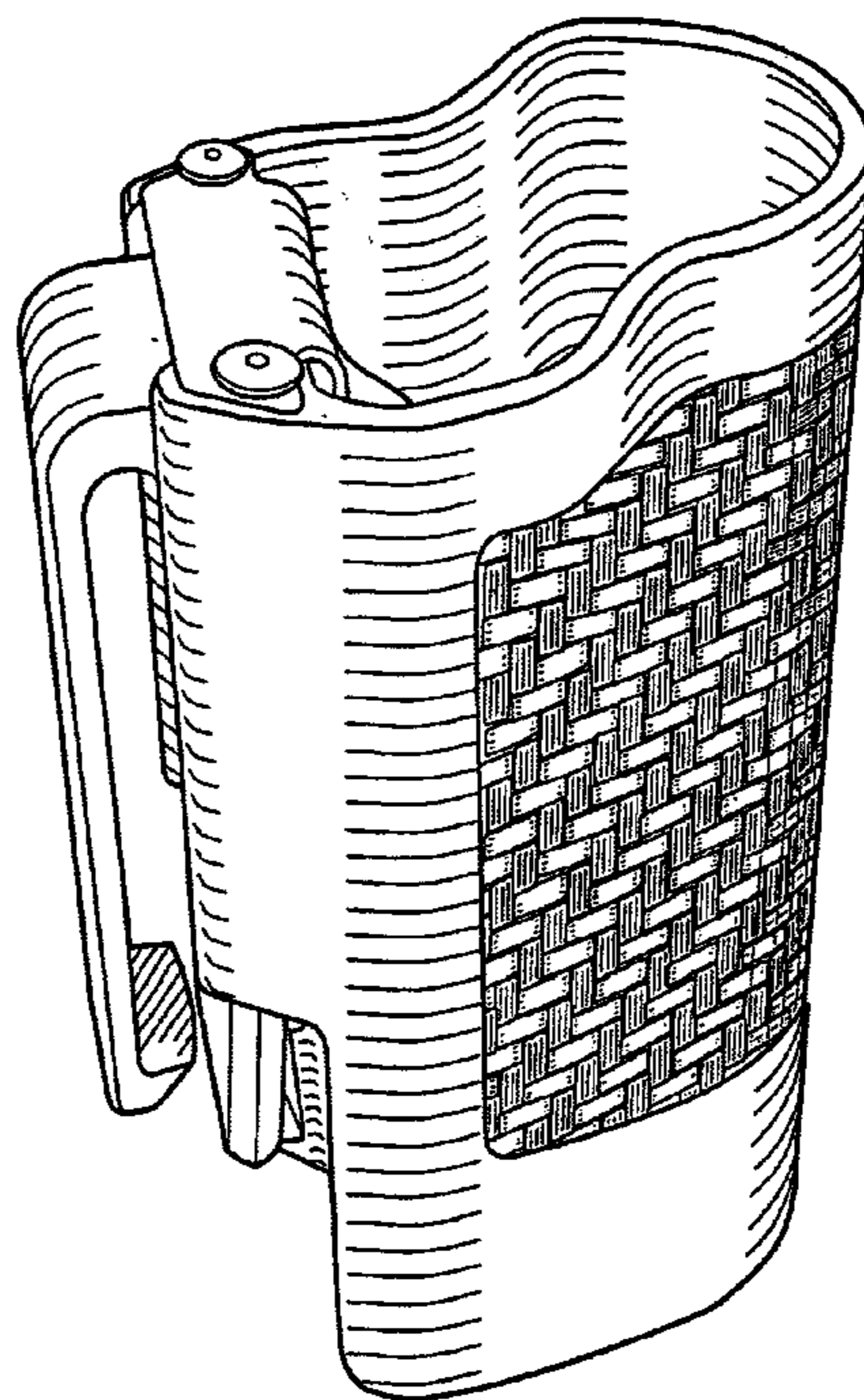

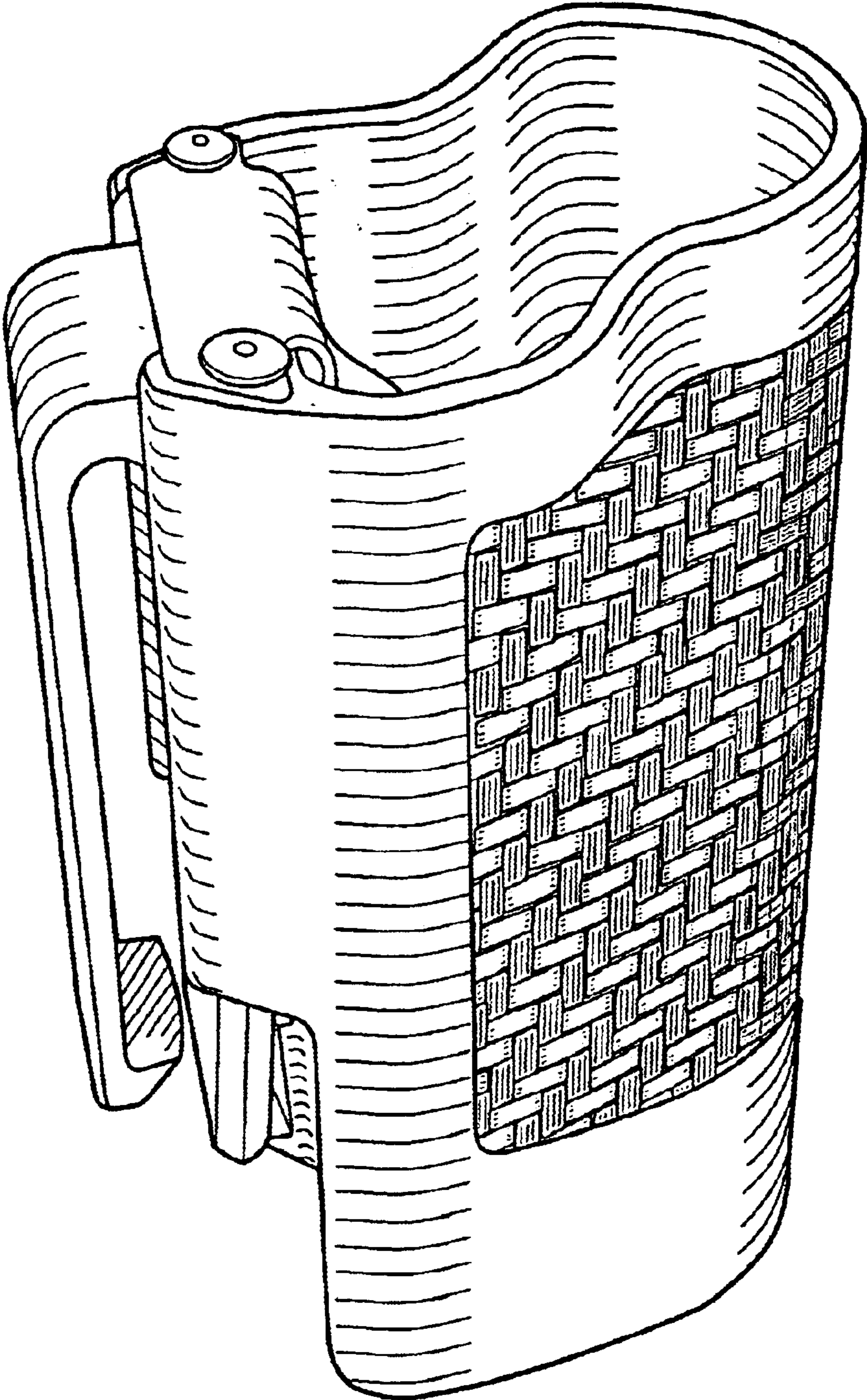

Fig. 1

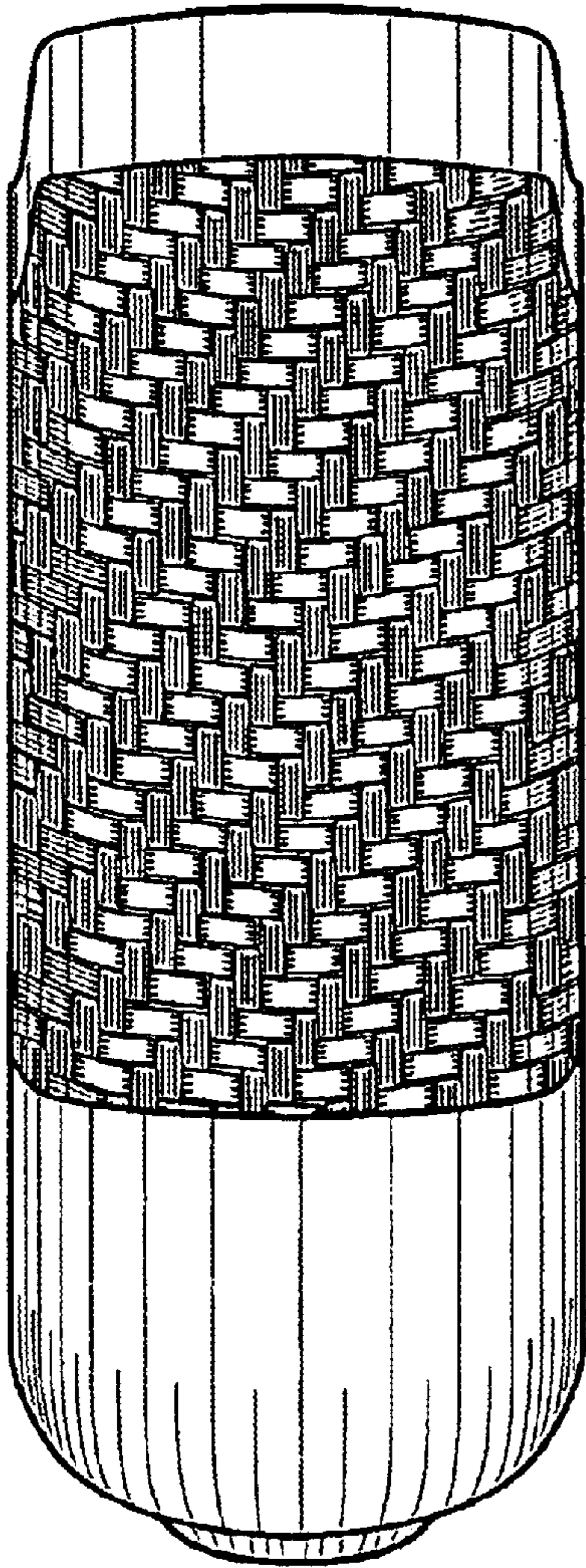

Fig. 2

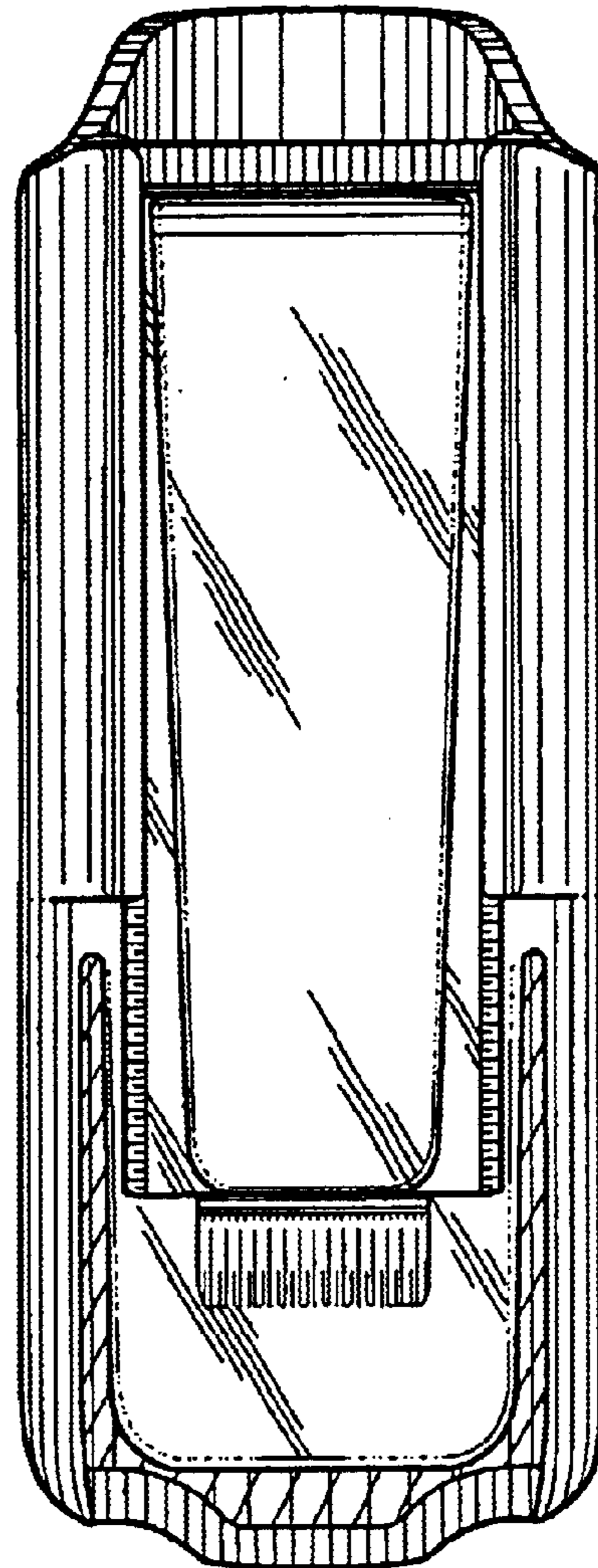

Fig. 3

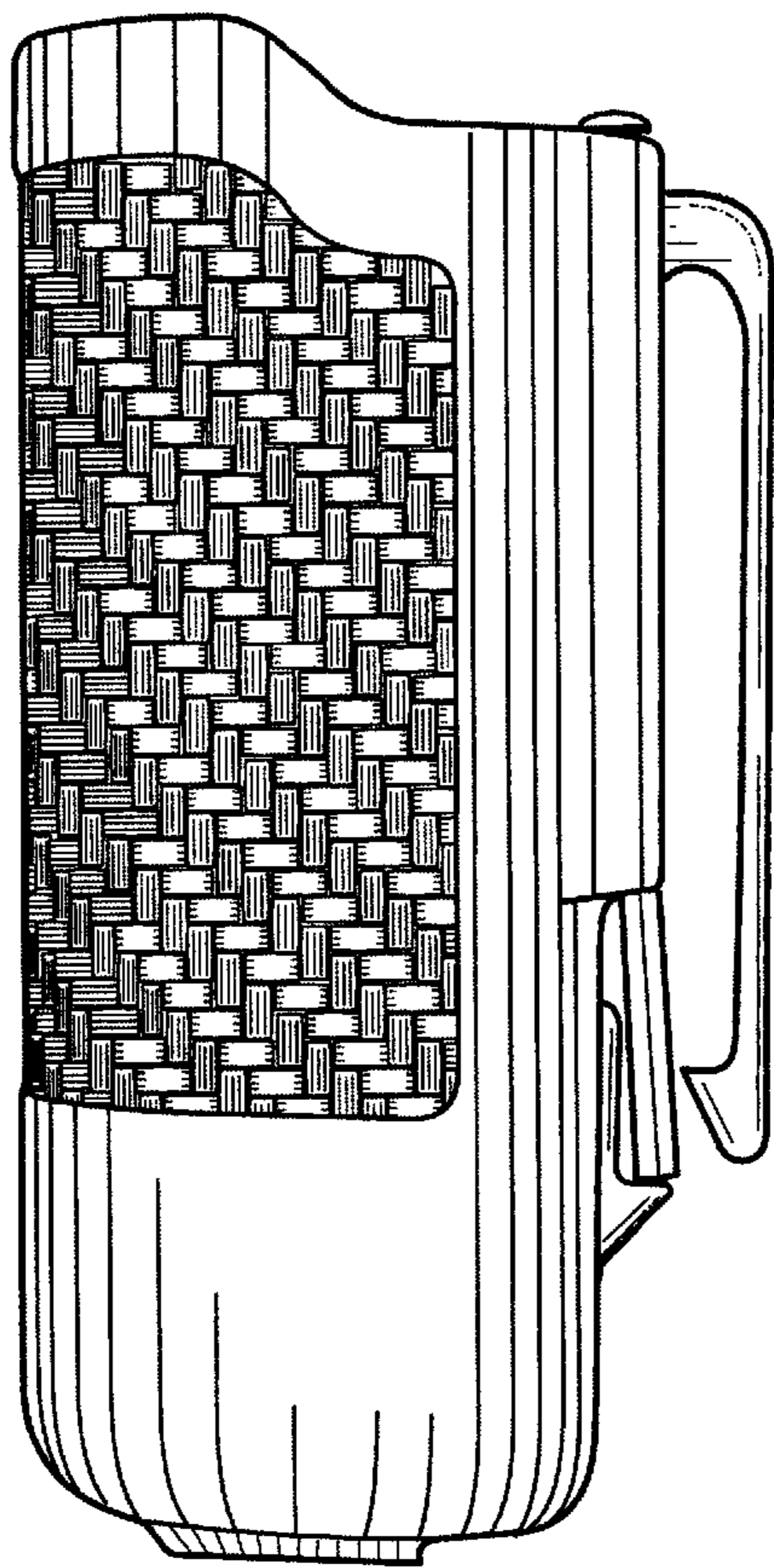

Fig. 4

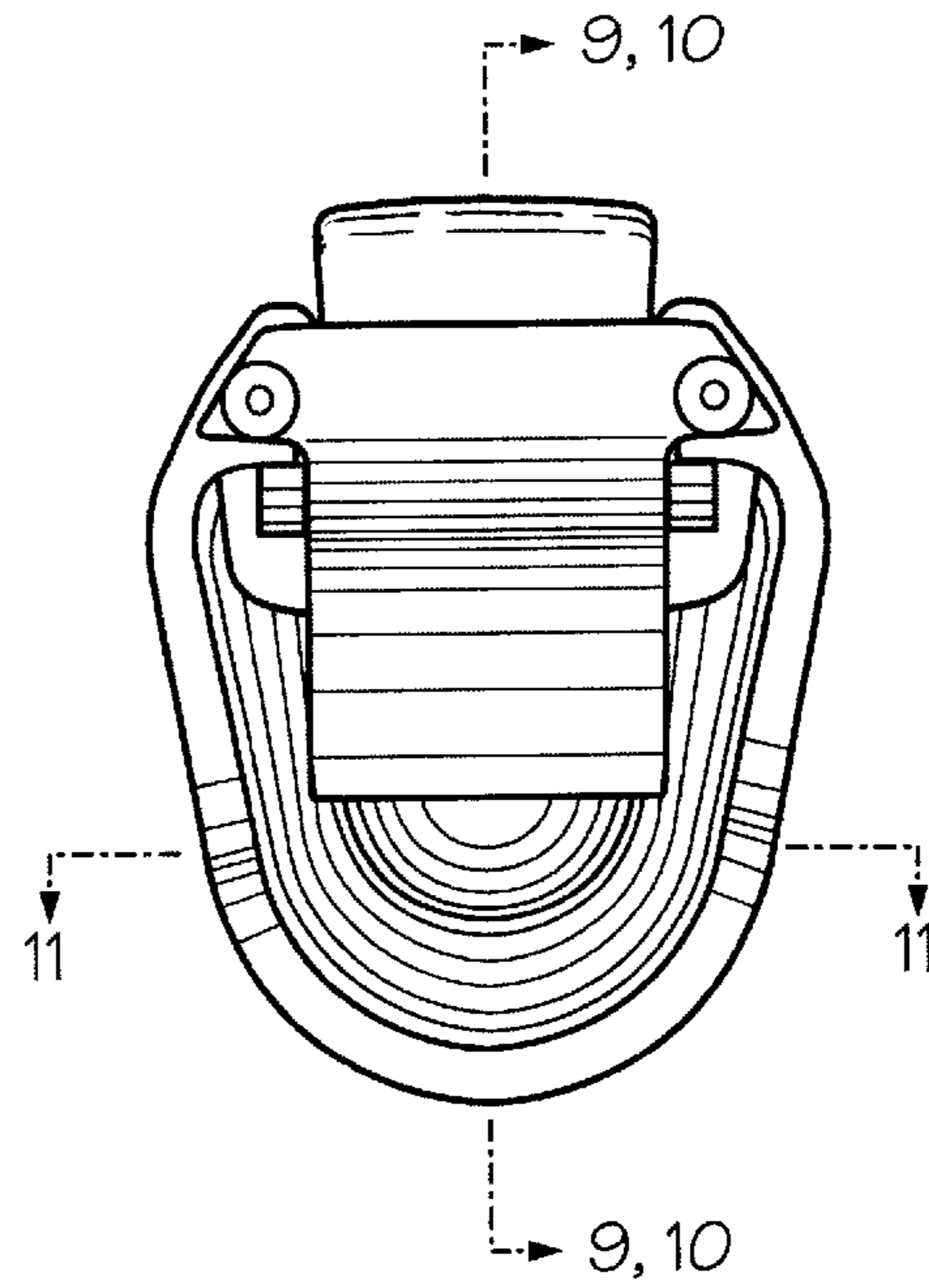

Fig. 5

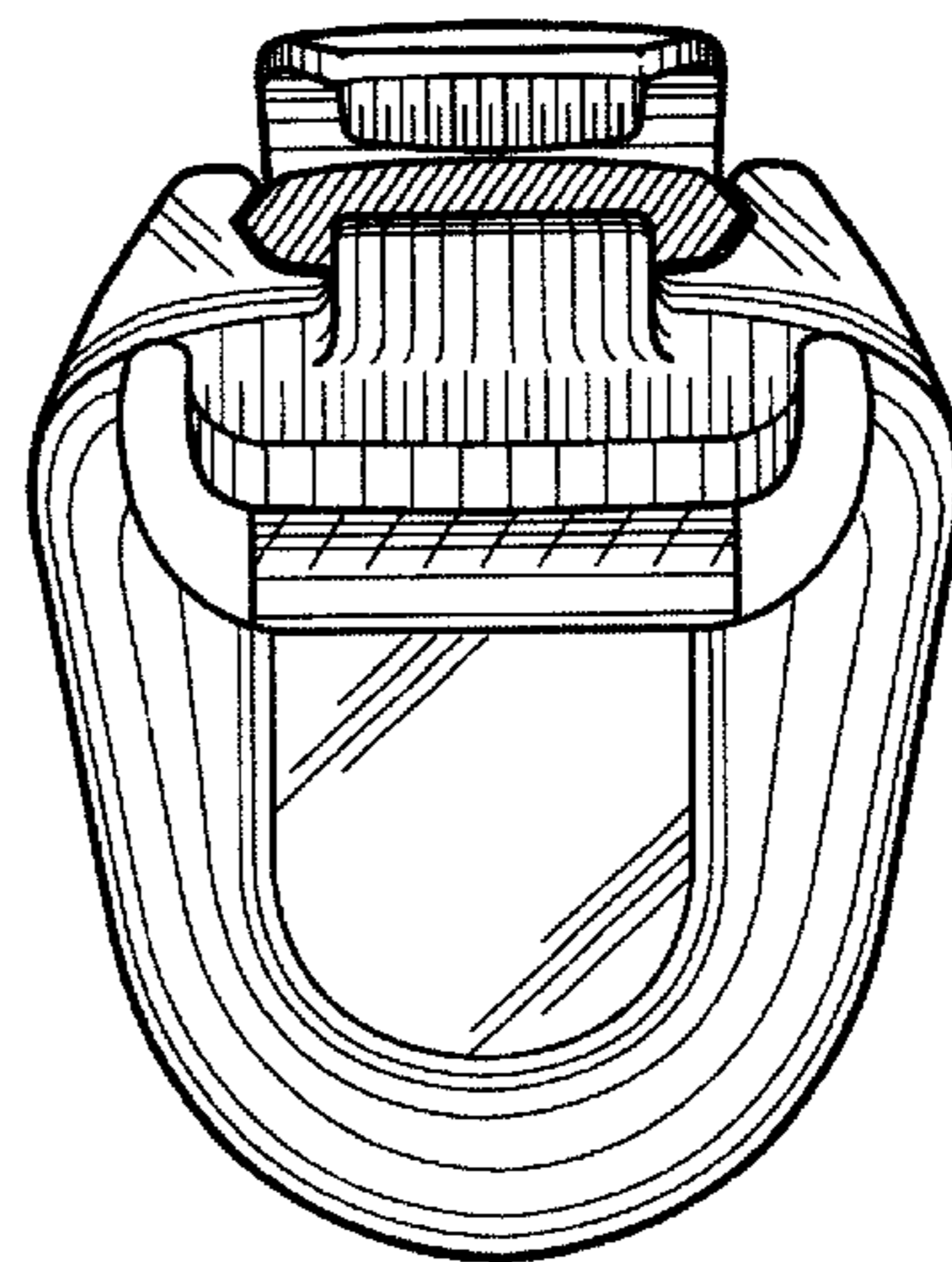

Fig. 6

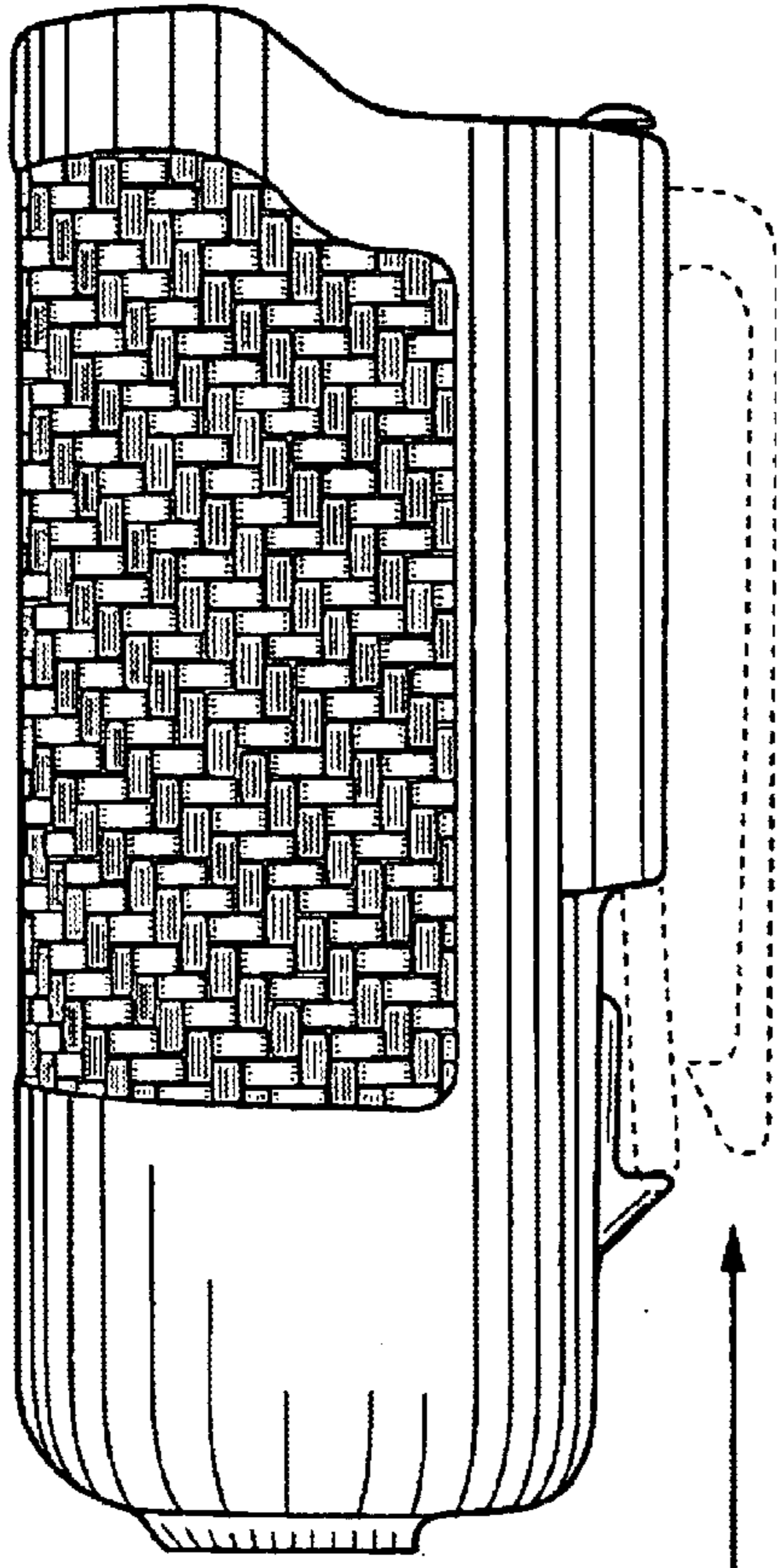

Fig. 7

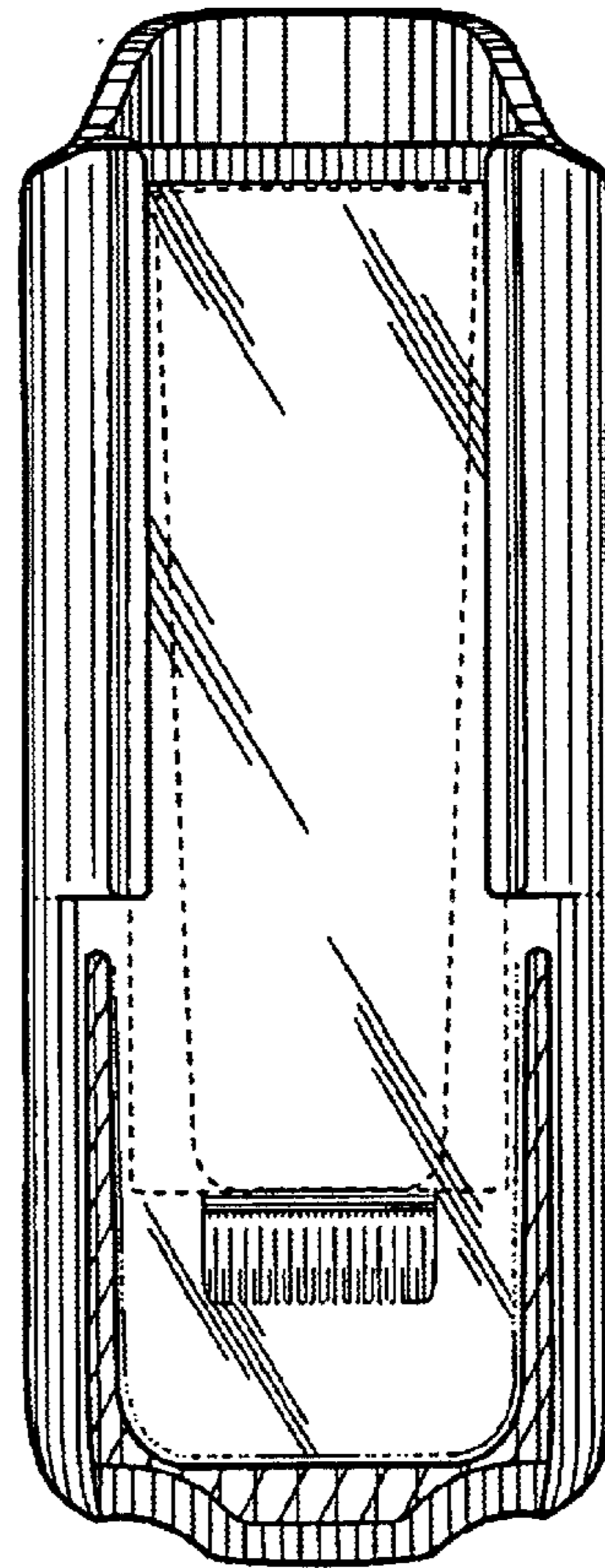
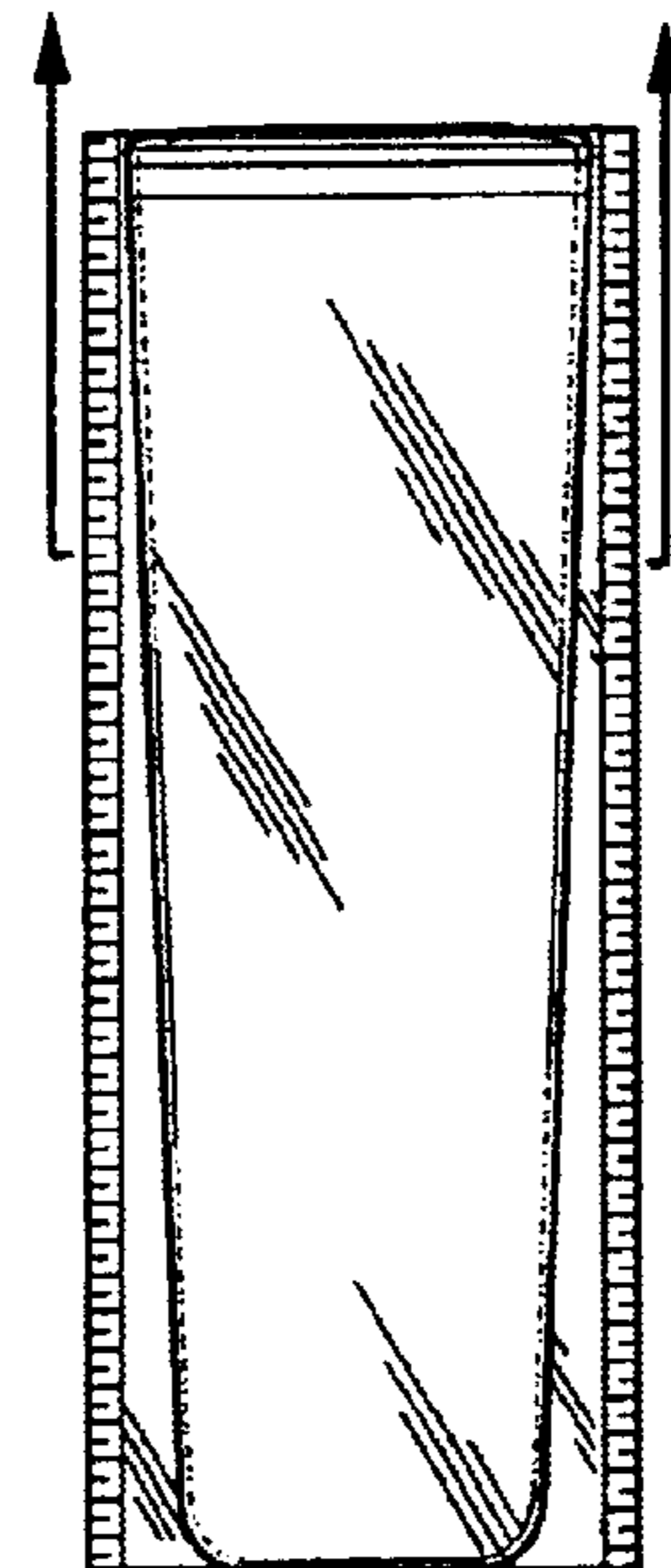

Fig. 8



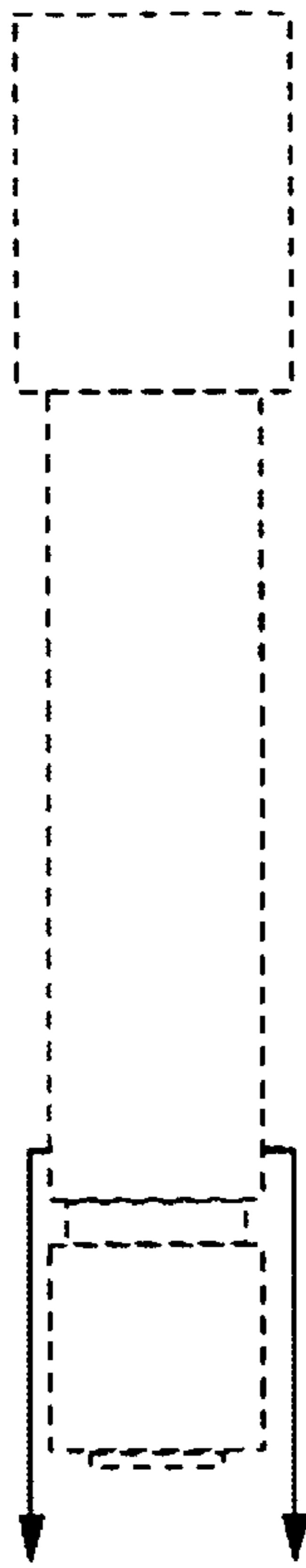

Fig. 9

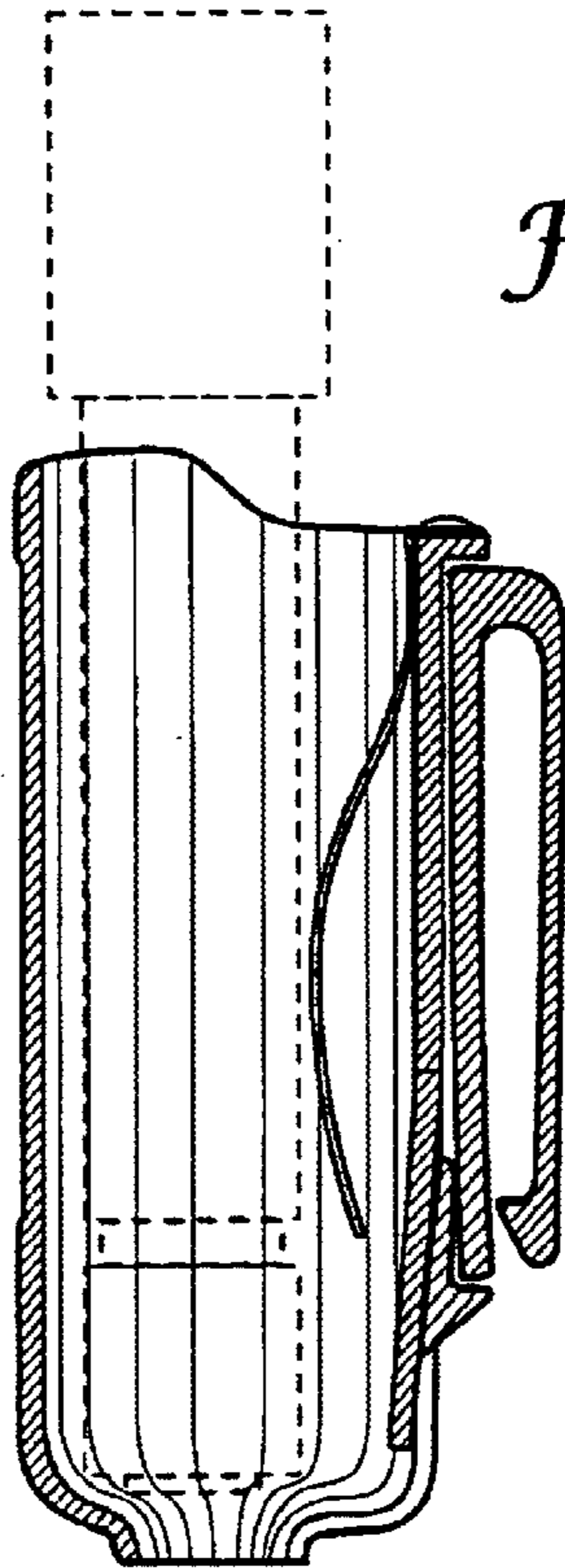
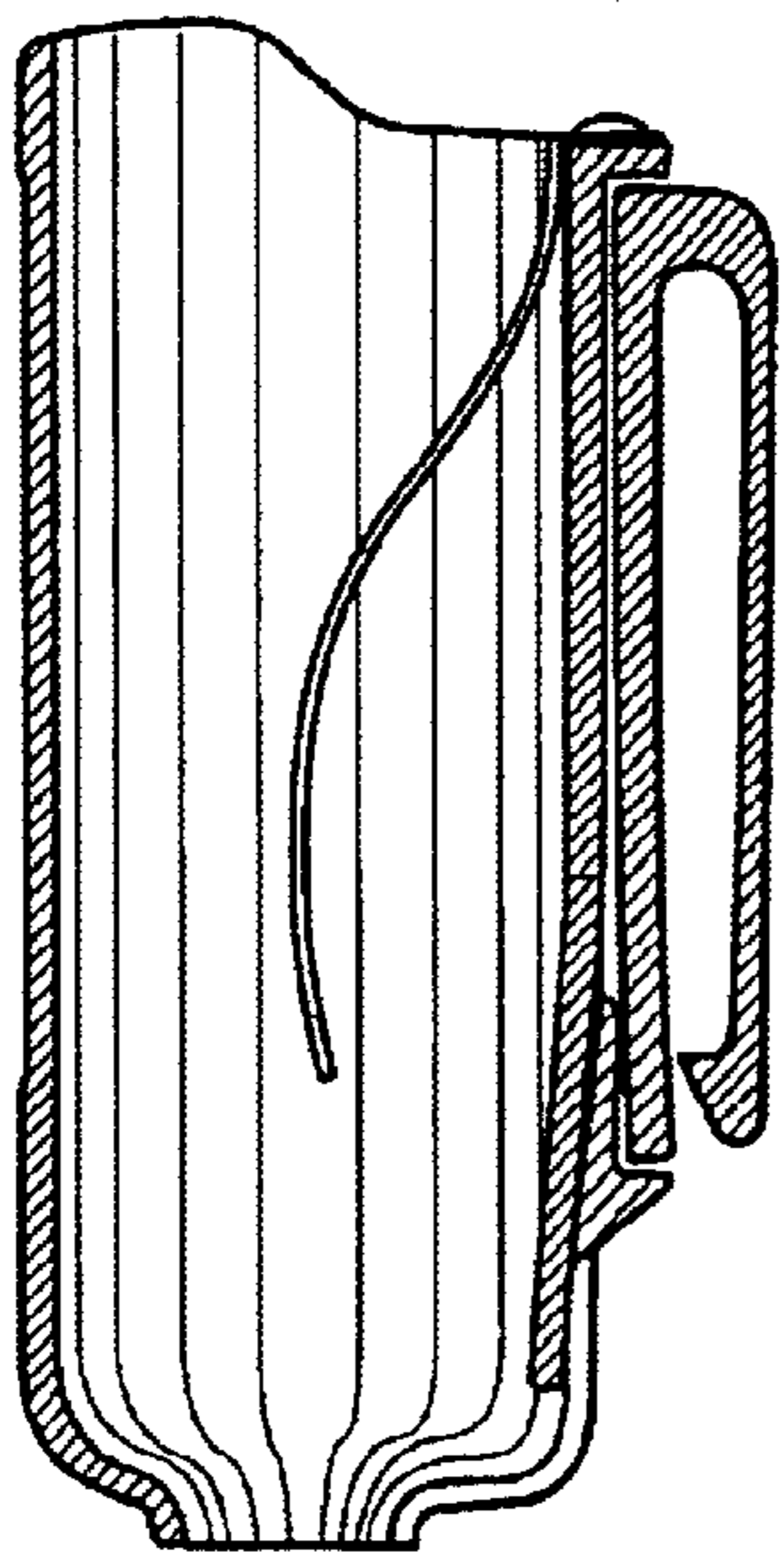

Fig. 10

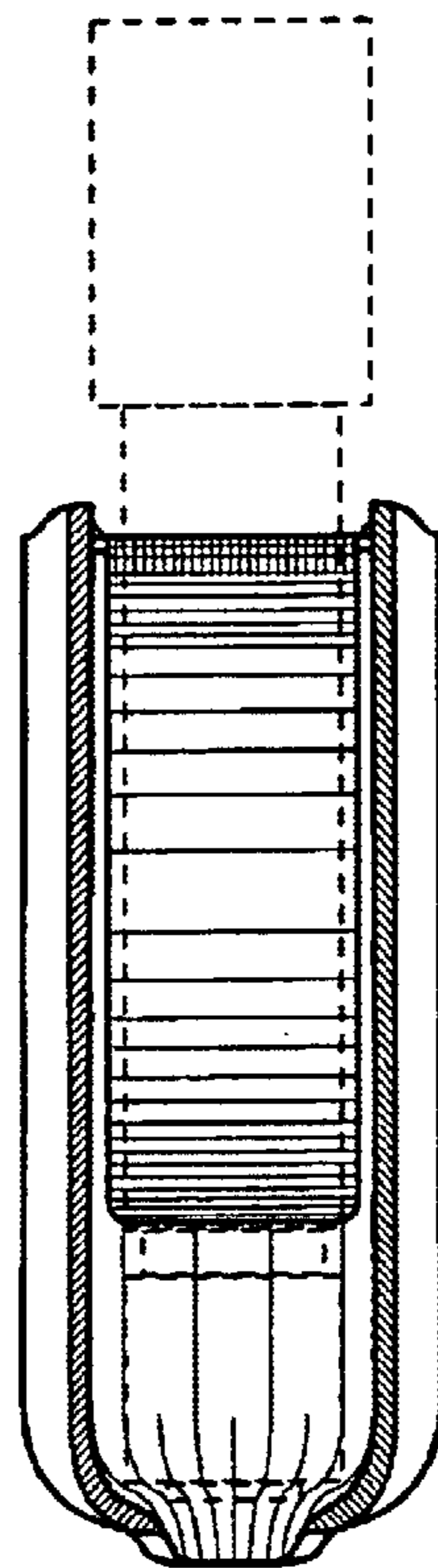

Fig. 11