

US00D502972S

(12) **United States Design Patent**
DeLisle et al.

(10) **Patent No.:** **US D502,972 S**
(45) **Date of Patent:** **** Mar. 15, 2005**

(54) **GOLF TEE**
(75) Inventors: **Stephen P. DeLisle**, Carolina Shores, NC (US); **Benjamin J. Maloy**, Carolina Shores, NC (US)
(73) Assignee: **Evolve Golf**, Carolina Shores, NC (US)
(**) Term: **14 Years**
(21) Appl. No.: **29/196,659**
(22) Filed: **Jan. 2, 2004**
(51) **LOC (7) Cl.** **21-02**
(52) **U.S. Cl.** **D21/718**
(58) **Field of Search** D21/715-720, D21/789, 793, 794, 796; 473/387-407

5,759,118 A 6/1998 Sroczyński
5,844,066 A 12/1998 Kakizawa
5,914,381 A 6/1999 Terado et al.
6,010,413 A 1/2000 Pan-Chung
6,053,822 A 4/2000 Kolodney et al.
6,062,990 A 5/2000 Pierce
6,110,059 A 8/2000 Haggarty
6,139,449 A 10/2000 Cardarelli
6,231,970 B1 5/2001 Andersen et al.
6,280,350 B1 8/2001 Chung
6,319,156 B1 11/2001 Alexsen
6,344,003 B1 2/2002 Choung
6,454,669 B1 9/2002 James
D485,318 S * 1/2004 Bonfanti D21/718

* cited by examiner

Primary Examiner—Catherine Tuttle
(74) *Attorney, Agent, or Firm*—Myers Bigel Sibley & Sajovec

(56) **References Cited**

U.S. PATENT DOCUMENTS

638,920 A 12/1899 Grant
702,078 A 6/1902 Stockder, Jr.
1,522,544 A 1/1925 Pryde
D67,255 S * 5/1925 Alvord D21/718
1,638,527 A * 8/1927 Clausing 473/402
1,645,001 A * 10/1927 Hodges 71/23
1,670,627 A 5/1928 Lowell
1,681,391 A * 8/1928 Bratt 473/400
2,011,203 A 8/1935 Seiki
2,455,705 A * 12/1948 Seager 473/402
D161,602 S * 1/1951 Ward D21/718
3,203,700 A * 8/1965 Antonious 473/257
3,954,263 A * 5/1976 Whelan et al. 473/399
4,103,888 A 8/1978 Ricketts
4,783,077 A 11/1988 Lemon
5,085,438 A 2/1992 Takeno
5,154,417 A 10/1992 Kohli
5,431,392 A 7/1995 Carson et al.
5,571,054 A 11/1996 Chantal
5,683,313 A 11/1997 Disco et al.
5,690,563 A 11/1997 Gammon
D393,301 S * 4/1998 Koskela D21/718

(57) **CLAIM**

The ornamental design for a golf tee, as shown and described.

DESCRIPTION

FIG. 1 is a bottom perspective view illustrating our golf tee design;
FIG. 2 is front view showing the design on a slightly reduced scale with respect to FIG. 1;
FIG. 3 is a side view thereof;
FIG. 4 is a top view showing the design on an enlarged scale with respect to the preceding figures;
FIG. 5 is a bottom view thereof;
FIG. 6 is a partial side section view thereof taken through lines 6—6 of FIG. 4; and,
FIG. 7 is a partial top perspective view showing the design on a further enlarged scale.
The tee is shown partially broken away in FIGS. 6 and 7 for ease of illustration.

1 Claim, 7 Drawing Sheets

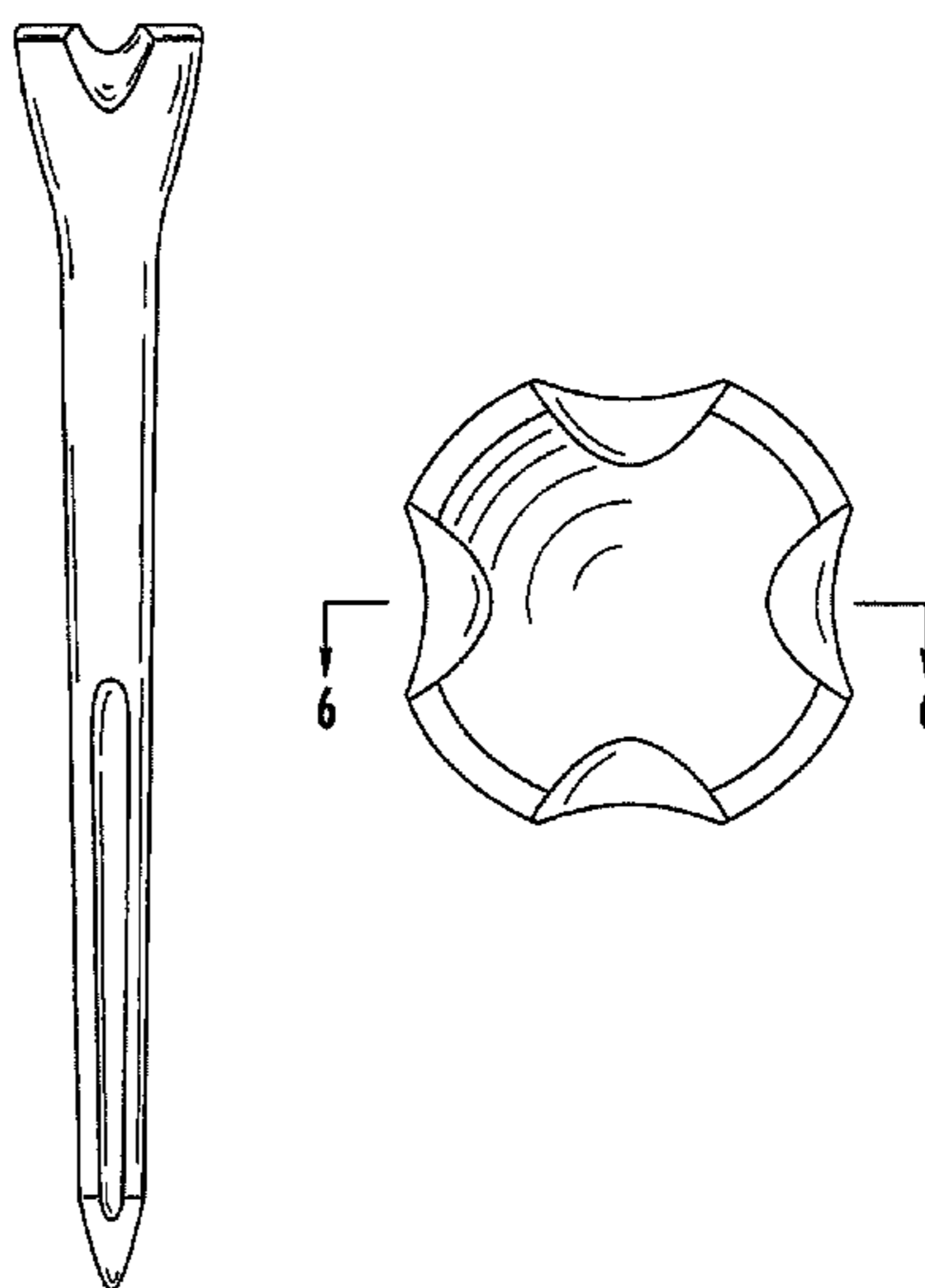

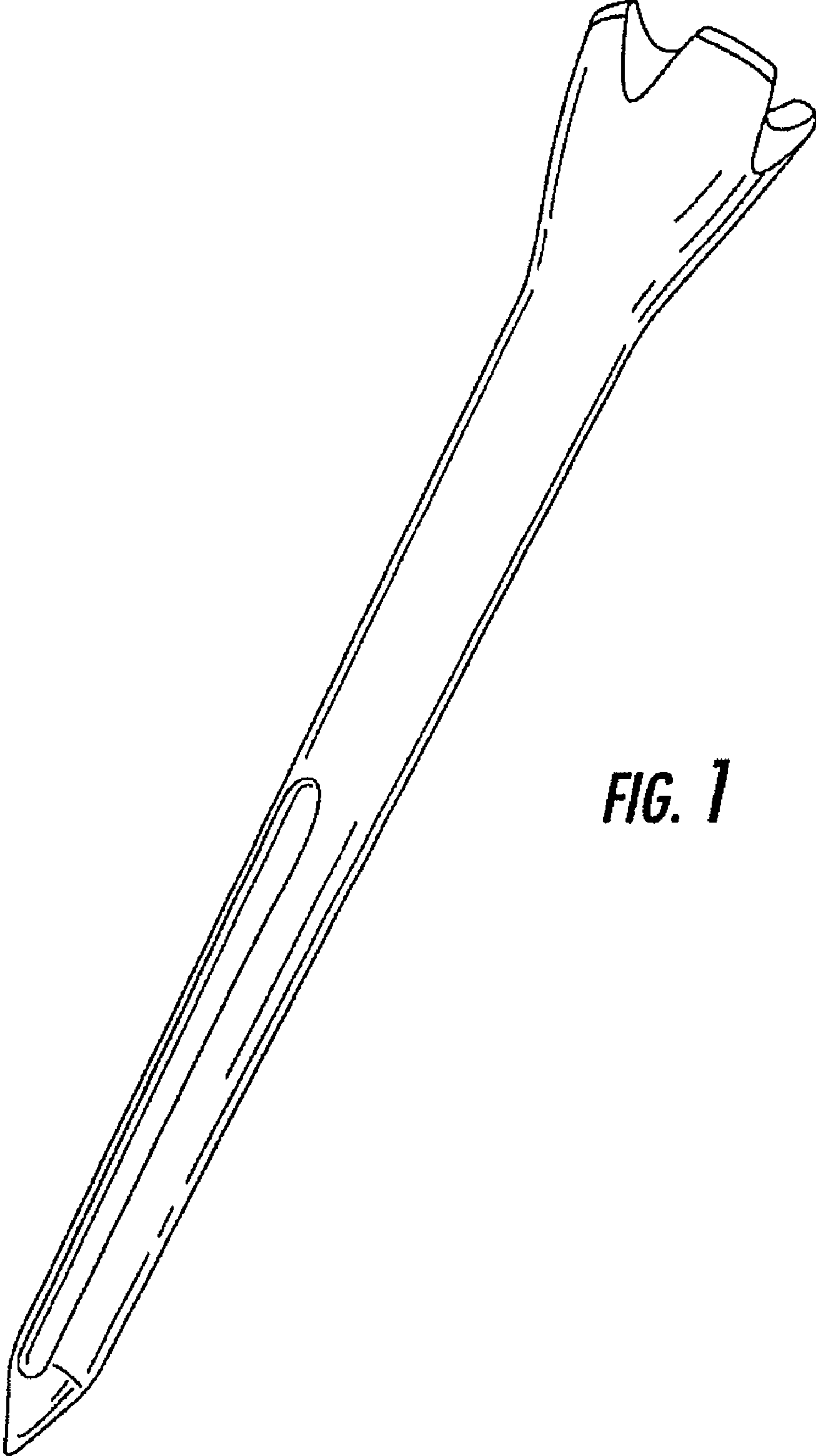

FIG. 1

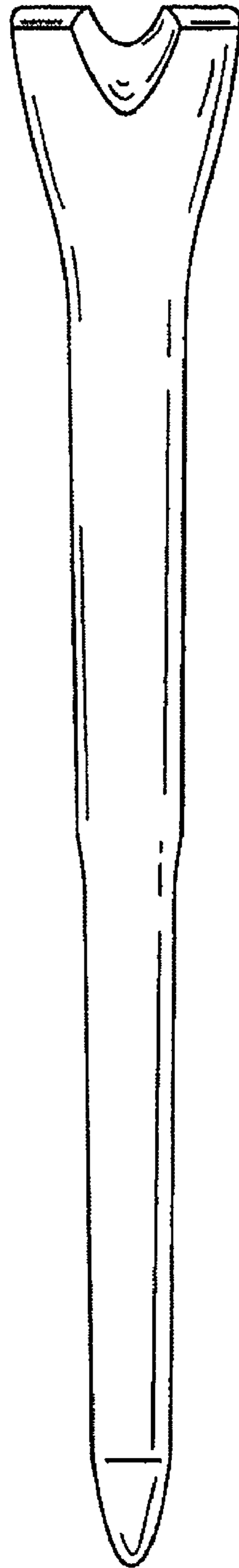

FIG. 2

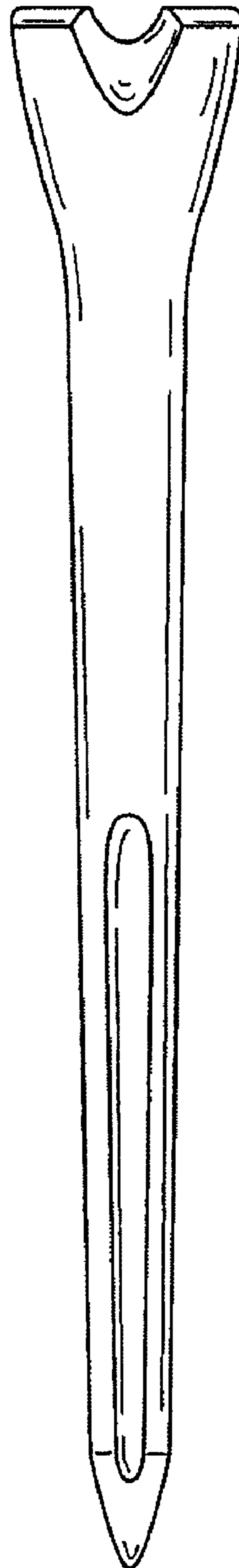

FIG. 3

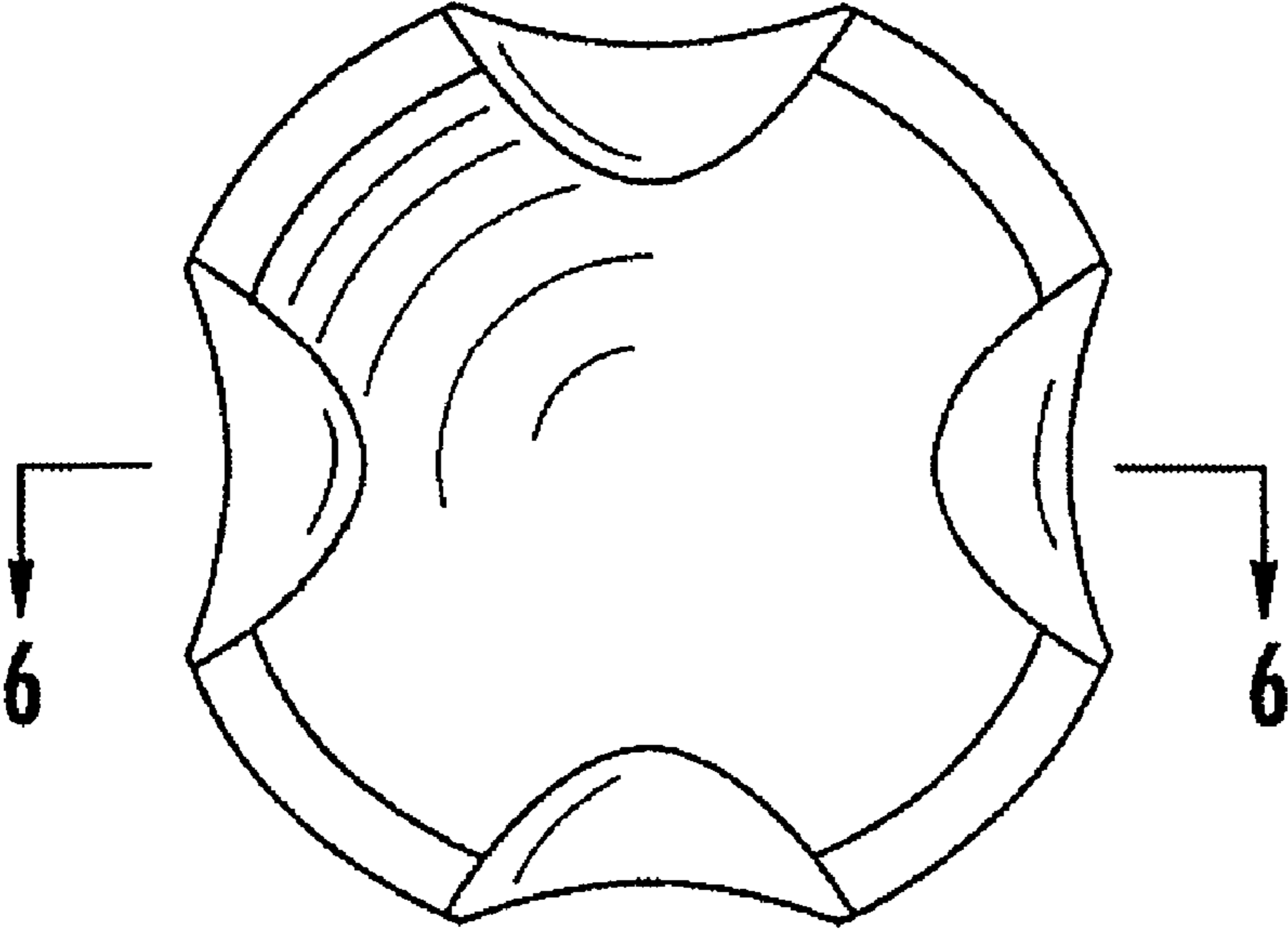

FIG. 4

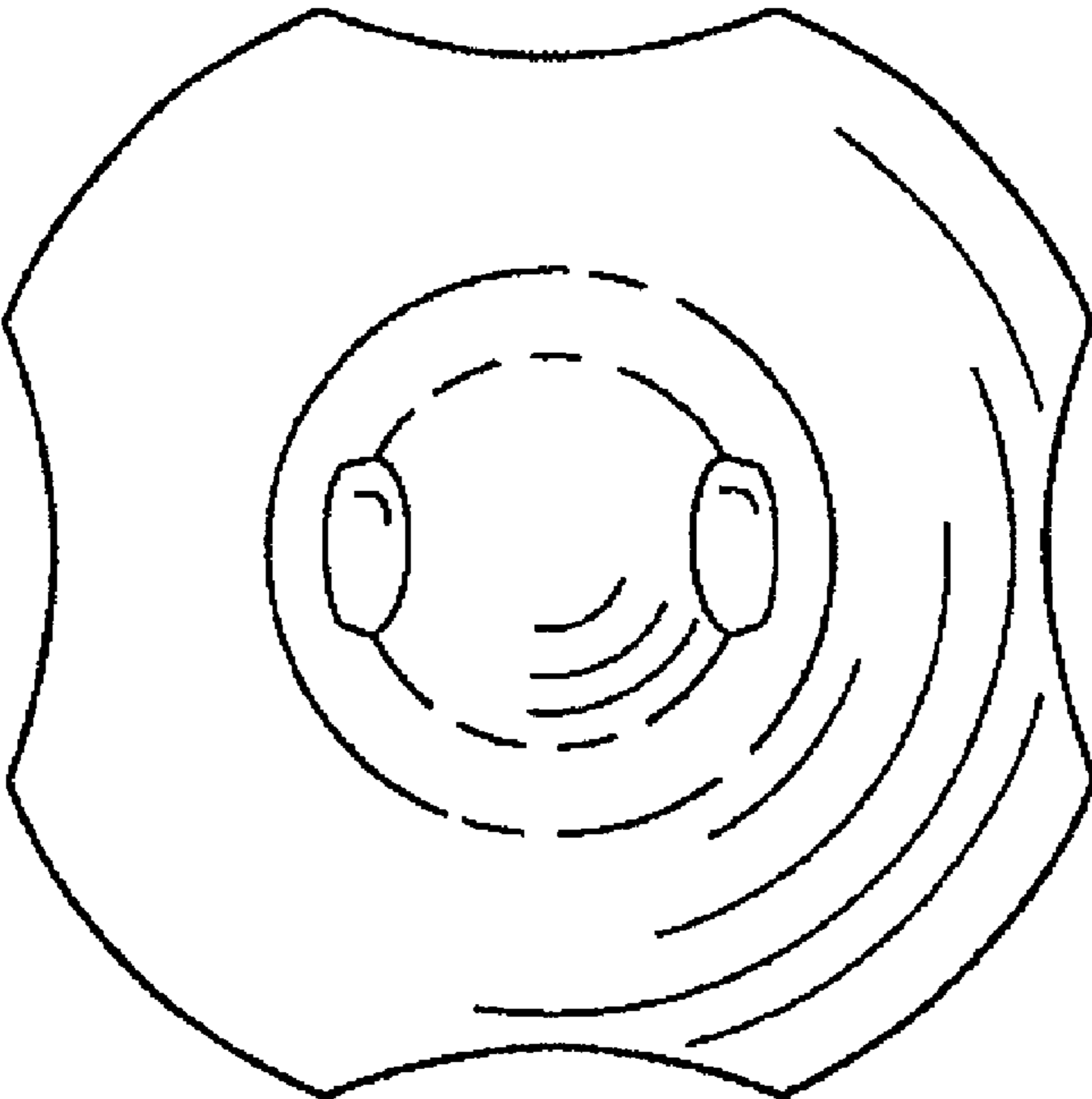

FIG. 5

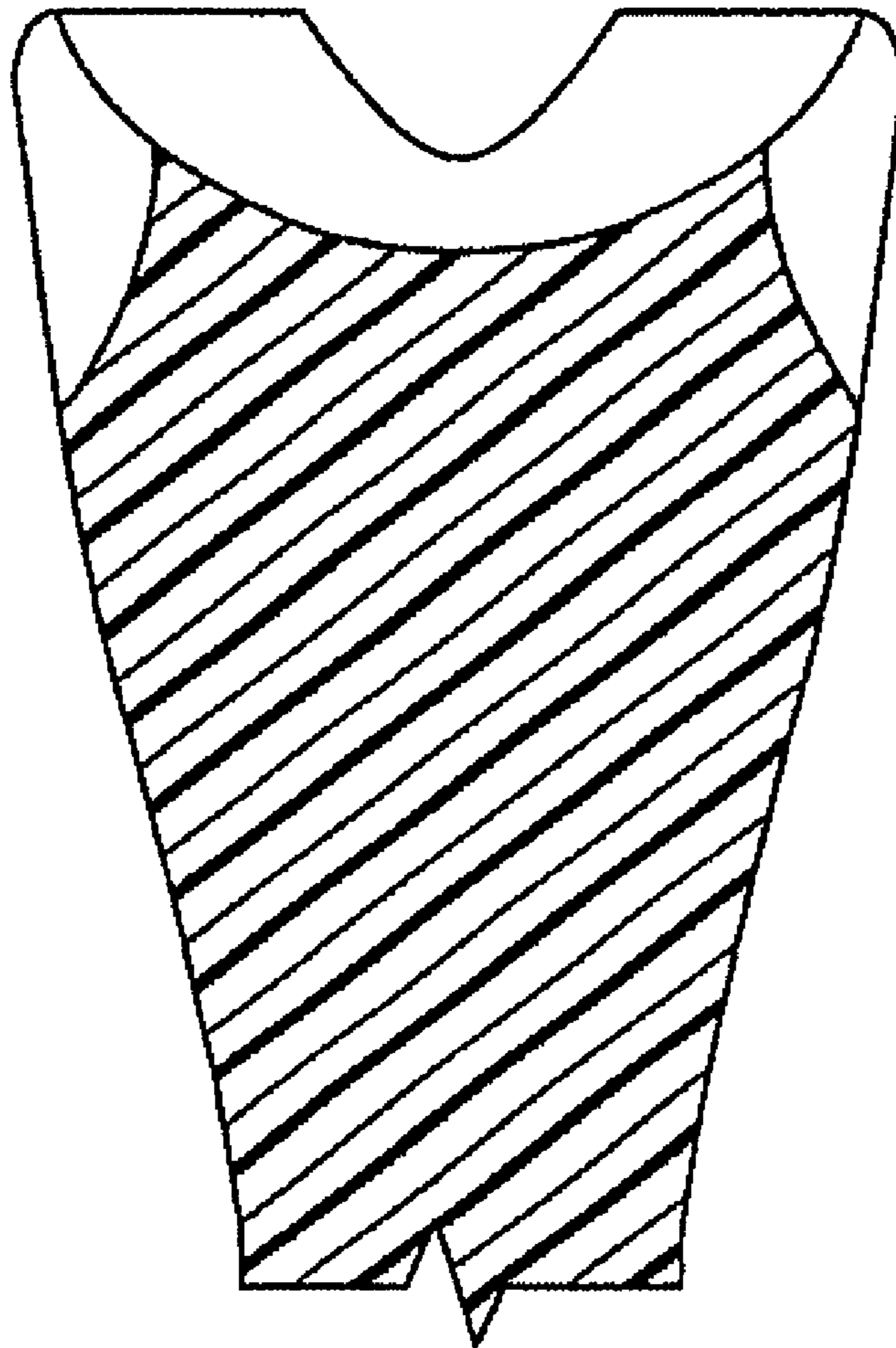

FIG. 6

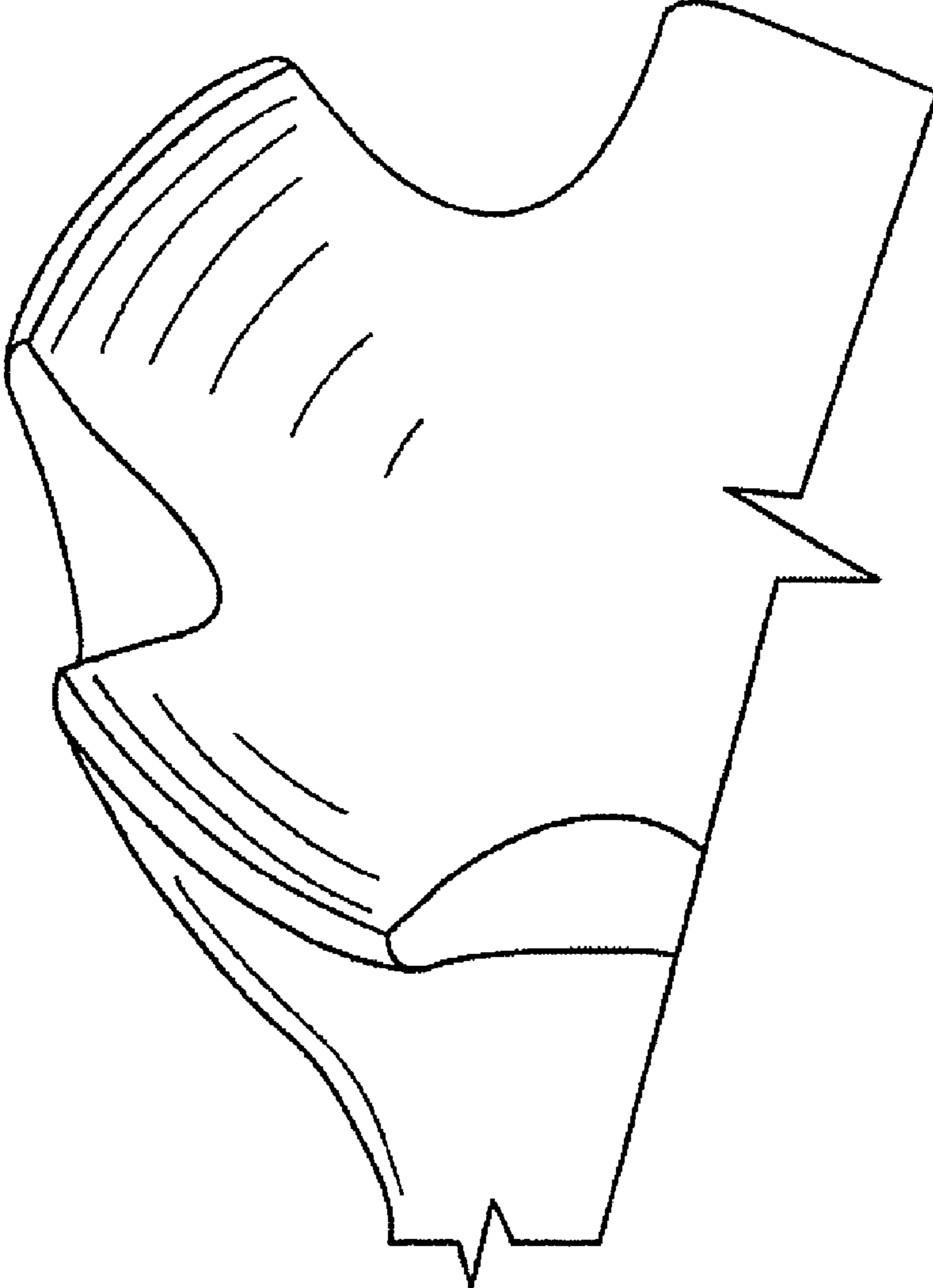

FIG. 7