

US00D502915S

(12) **United States Design Patent**  
**Higuchi et al.**

(10) **Patent No.: US D502,915 S**  
(45) **Date of Patent: \*\* Mar. 15, 2005**

(54) **INVERTER**  
(75) Inventors: **Naoto Higuchi**, Tokyo (JP); **Michihiro Arisato**, Tokyo (JP)

D455,121 S \* 4/2002 Takeuchi et al. .... D13/110  
D455,714 S \* 4/2002 Kim ..... D13/110  
D457,492 S \* 5/2002 Kim ..... D13/110  
D494,132 S \* 8/2004 Song ..... D13/110  
D494,133 S \* 8/2004 Song ..... D13/110

(73) Assignee: **Mitsubishi Denki Kabushiki Kaisha**, Tokyo (JP)

\* cited by examiner

(\*\*) Term: **14 Years**

*Primary Examiner*—Stella Reid  
*Assistant Examiner*—Daniel Bui

(21) Appl. No.: **29/202,791**

(74) *Attorney, Agent, or Firm*—Sughrue Mion, PLLC

(22) Filed: **Apr. 6, 2004**

(57) **CLAIM**

(30) **Foreign Application Priority Data**

The ornamental design for an inverter, as shown and described.

Oct. 8, 2003 (JP) ..... 2003-029708

**DESCRIPTION**

(51) **LOC (7) Cl.** ..... **13-02**  
(52) **U.S. Cl.** ..... **D13/110**  
(58) **Field of Search** ..... D13/101, 110,  
D13/112, 122–123, 162, 164, 184, 199;  
307/150; 363/141, 175, 600, 679, 692,  
727–728

FIG. 1 is a front, top and right side perspective view of a inverter, showing our new design;  
FIG. 2 is a front elevational view thereof;  
FIG. 3 is a rear elevational view thereof;  
FIG. 4 is a top plan view thereof;  
FIG. 5 is a bottom plan view thereof;  
FIG. 6 is a right side elevational view thereof;  
FIG. 7 is a left side elevational view thereof;  
FIG. 8 is a cross-sectional view thereof, taken along line 8—8 of FIG. 2, with the internal system omitted; and,  
FIG. 9 is a cross-sectional view thereof, taken along line 9—9 of FIG. 4, with the internal system omitted.

(56) **References Cited**

**U.S. PATENT DOCUMENTS**

D303,372 S \* 9/1989 Kondo et al. .... D13/110  
D372,017 S \* 7/1996 Suematsu et al. .... D13/110  
D380,193 S \* 6/1997 Yamaguchi et al. .... D13/110  
D449,817 S \* 10/2001 Takeuchi et al. .... D13/110

**1 Claim, 5 Drawing Sheets**

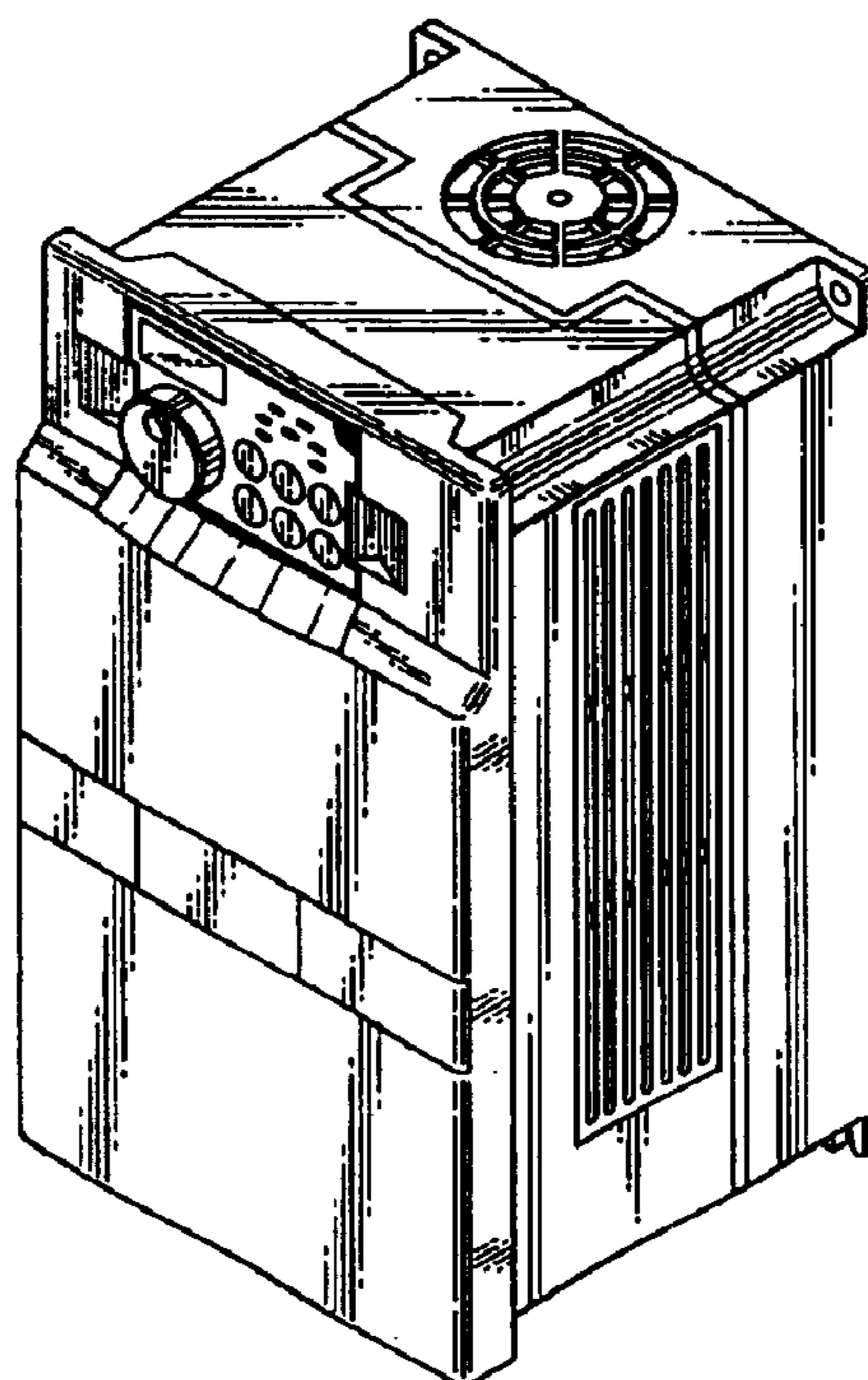

FIG. 1

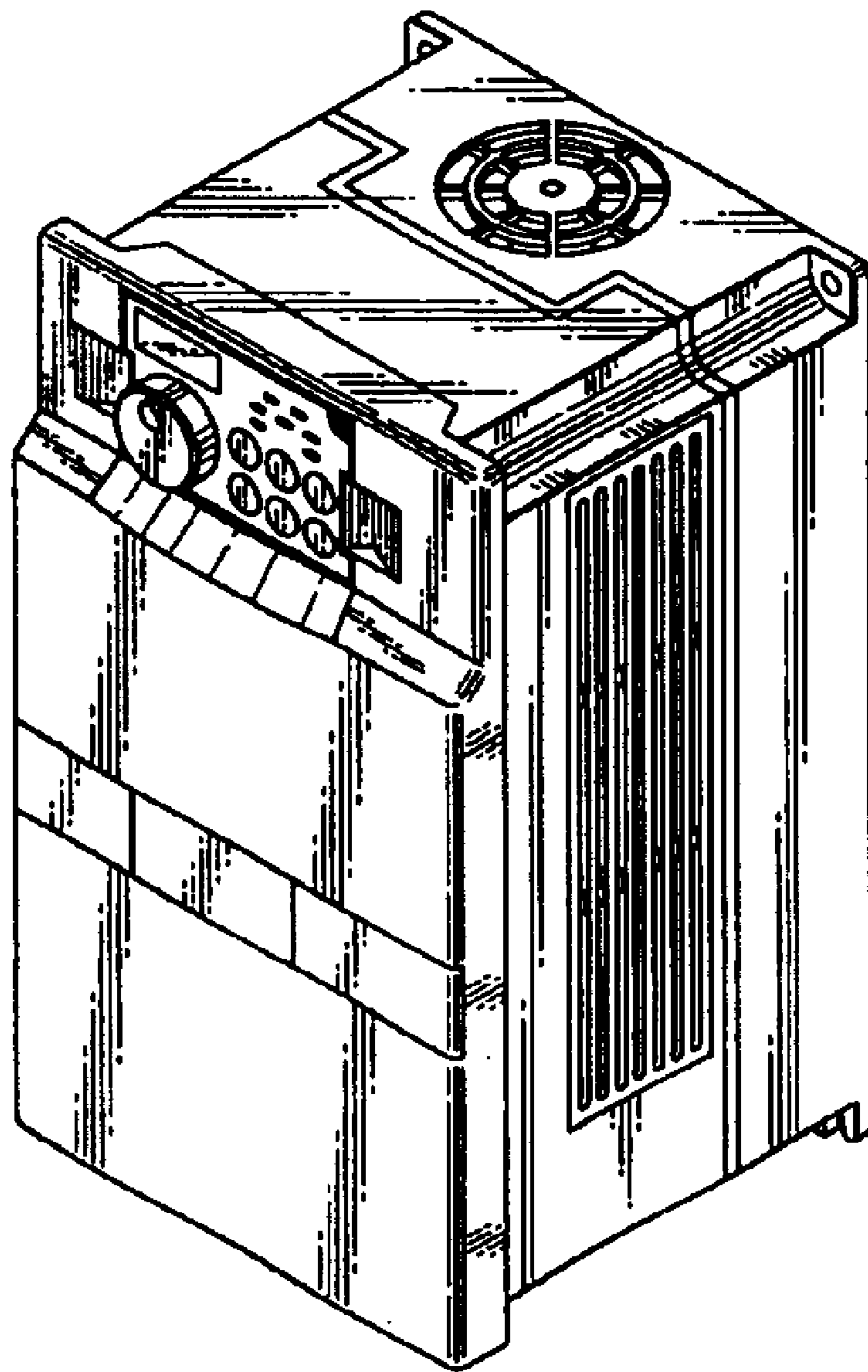

FIG.2

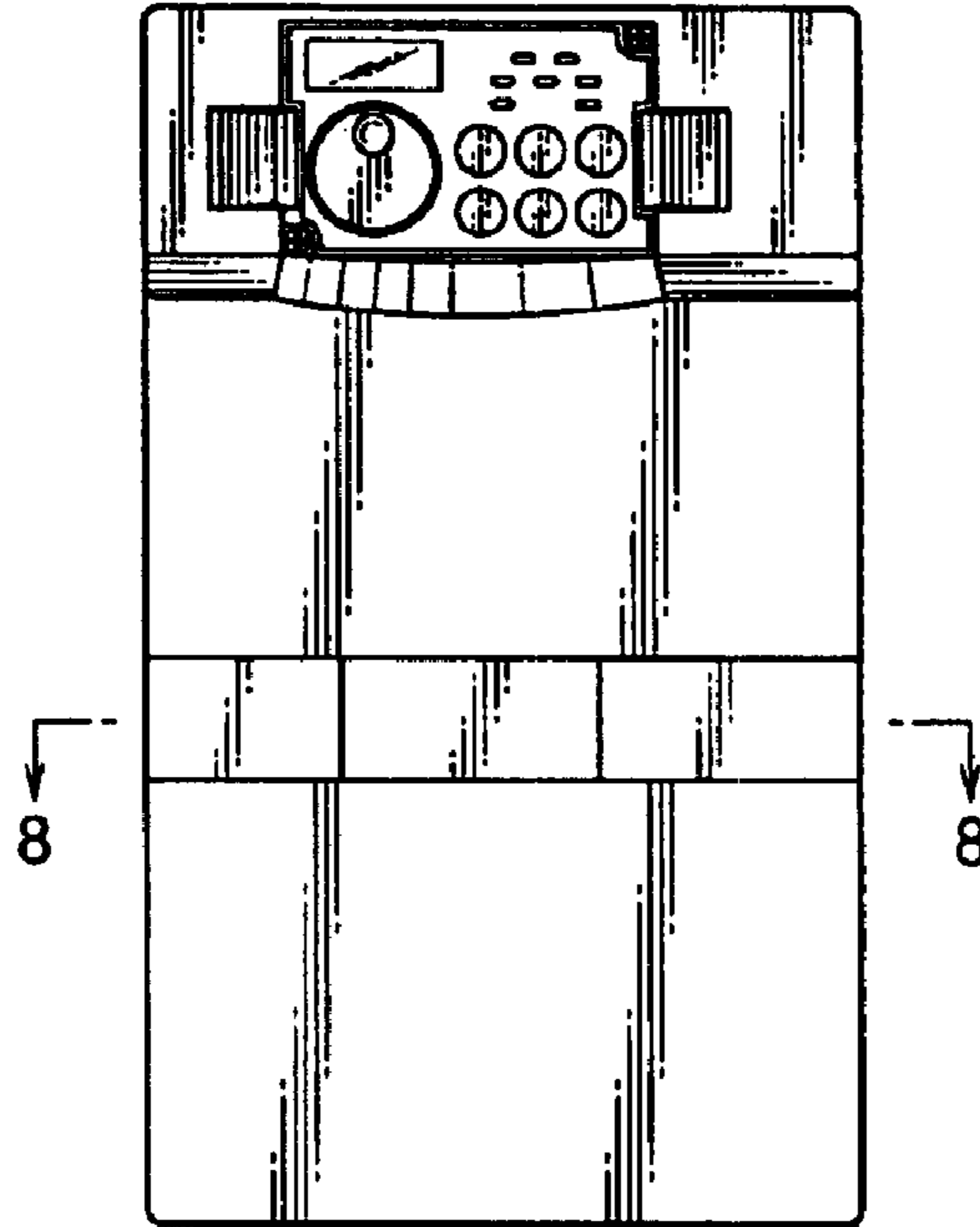

FIG.3

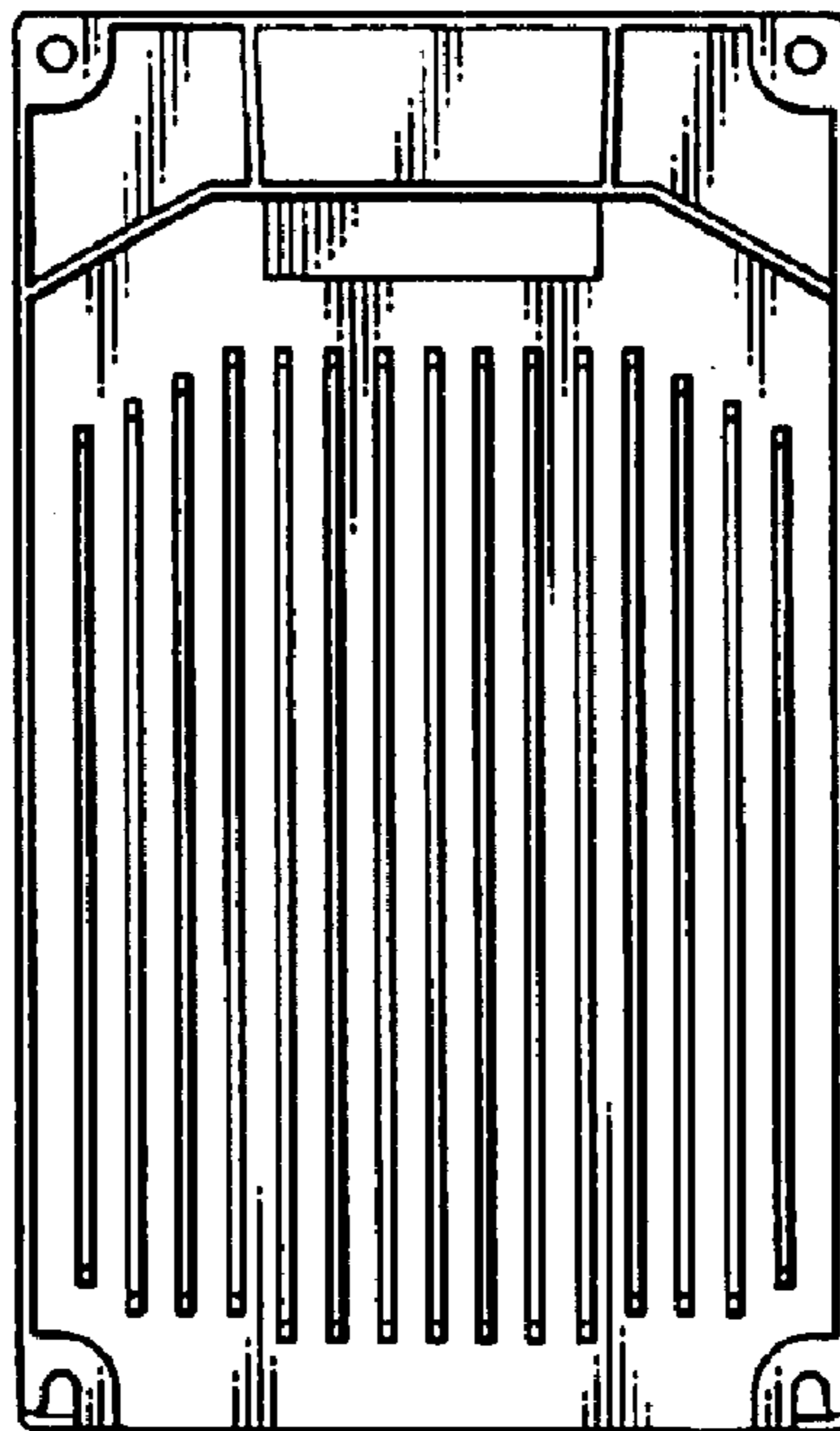

FIG.4

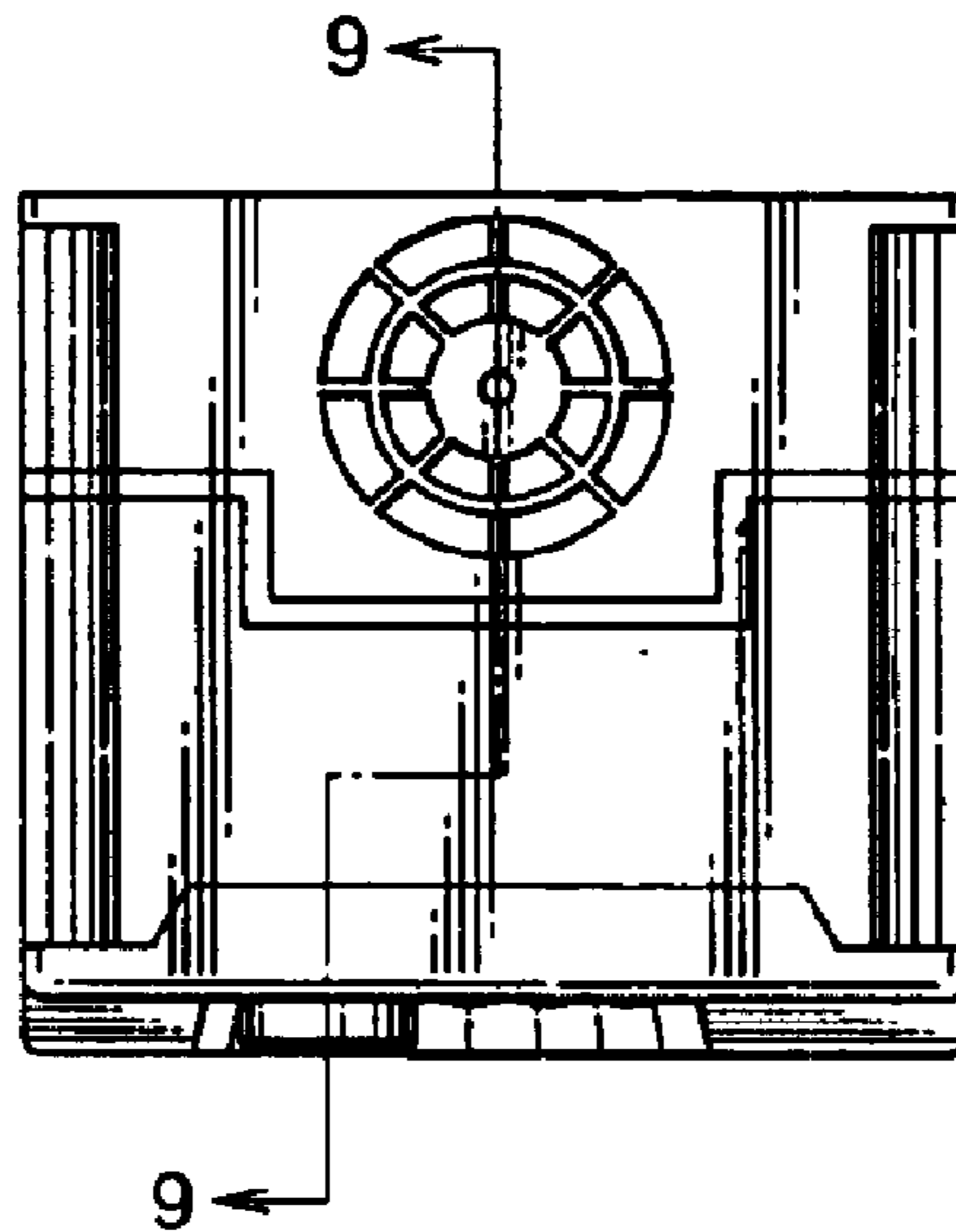

FIG.5

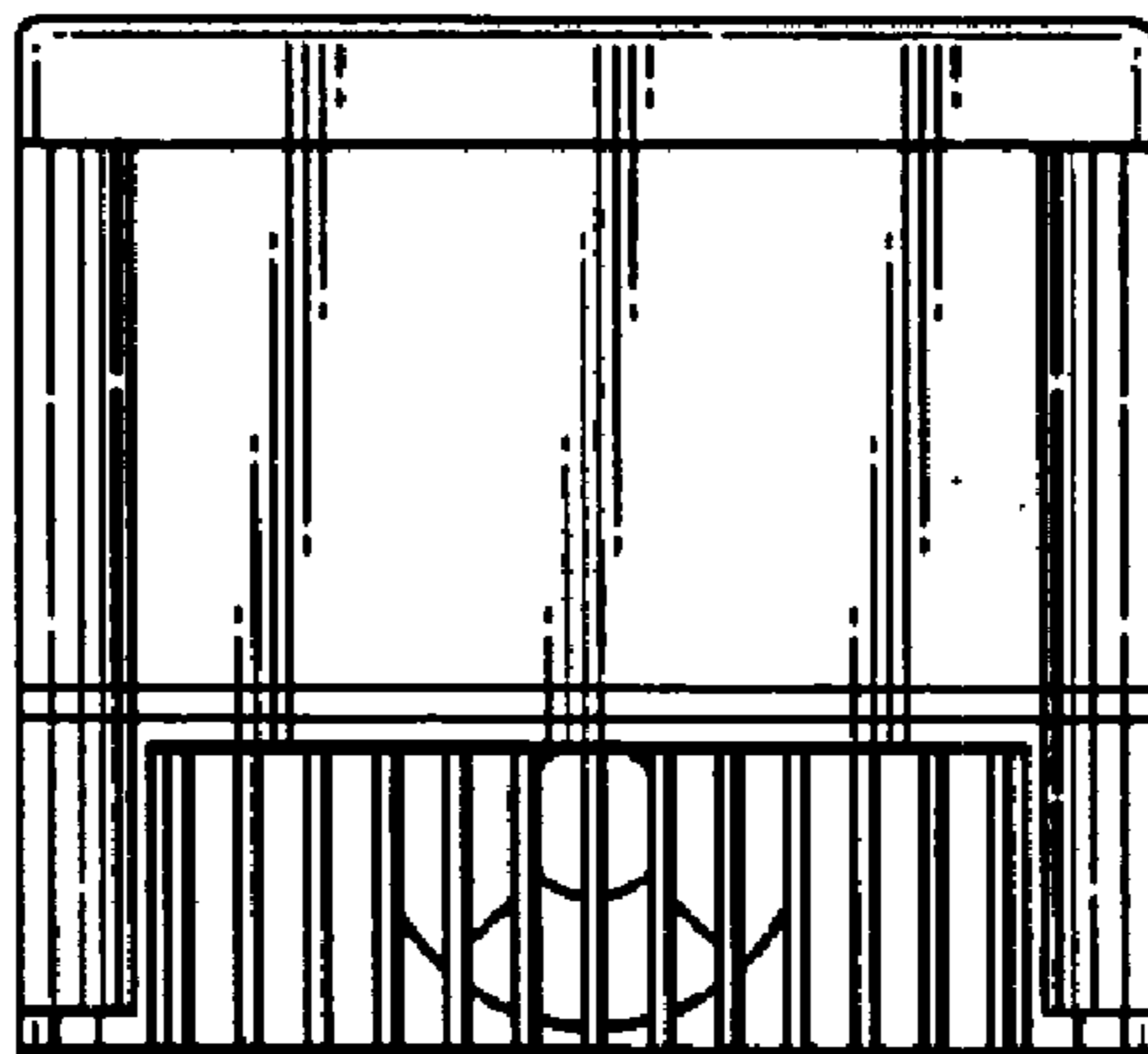

FIG. 6

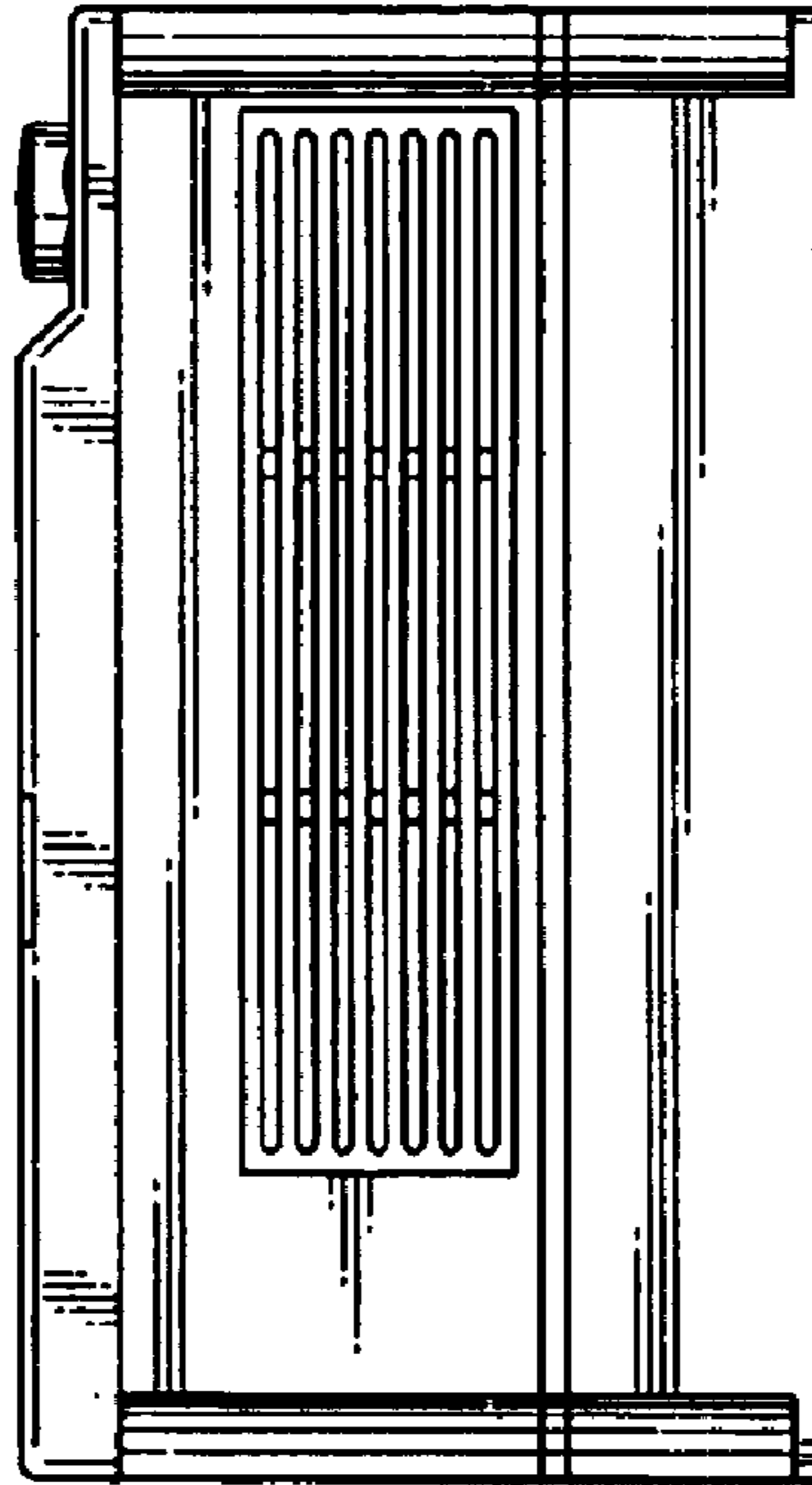

FIG. 7

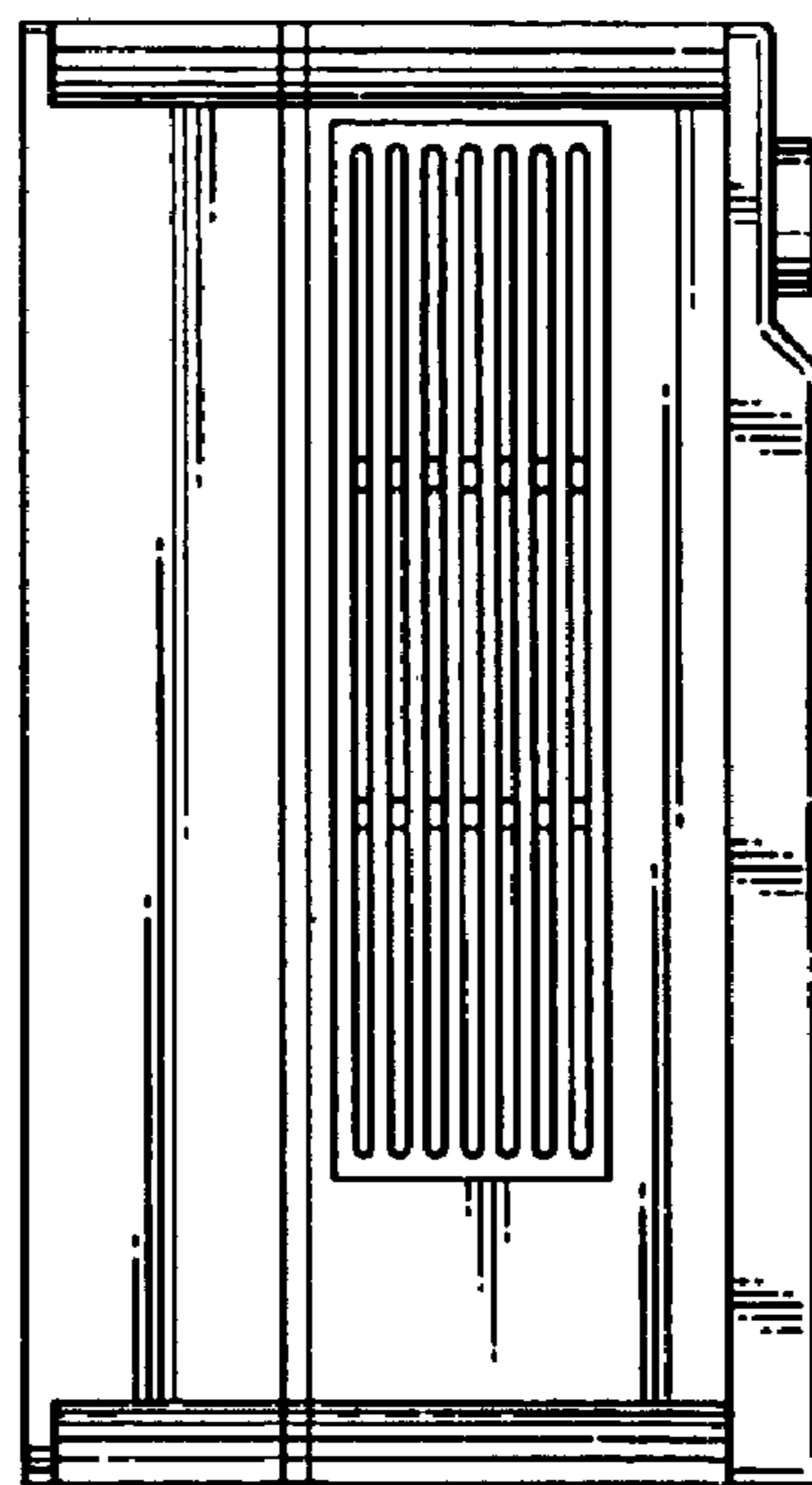

FIG. 8

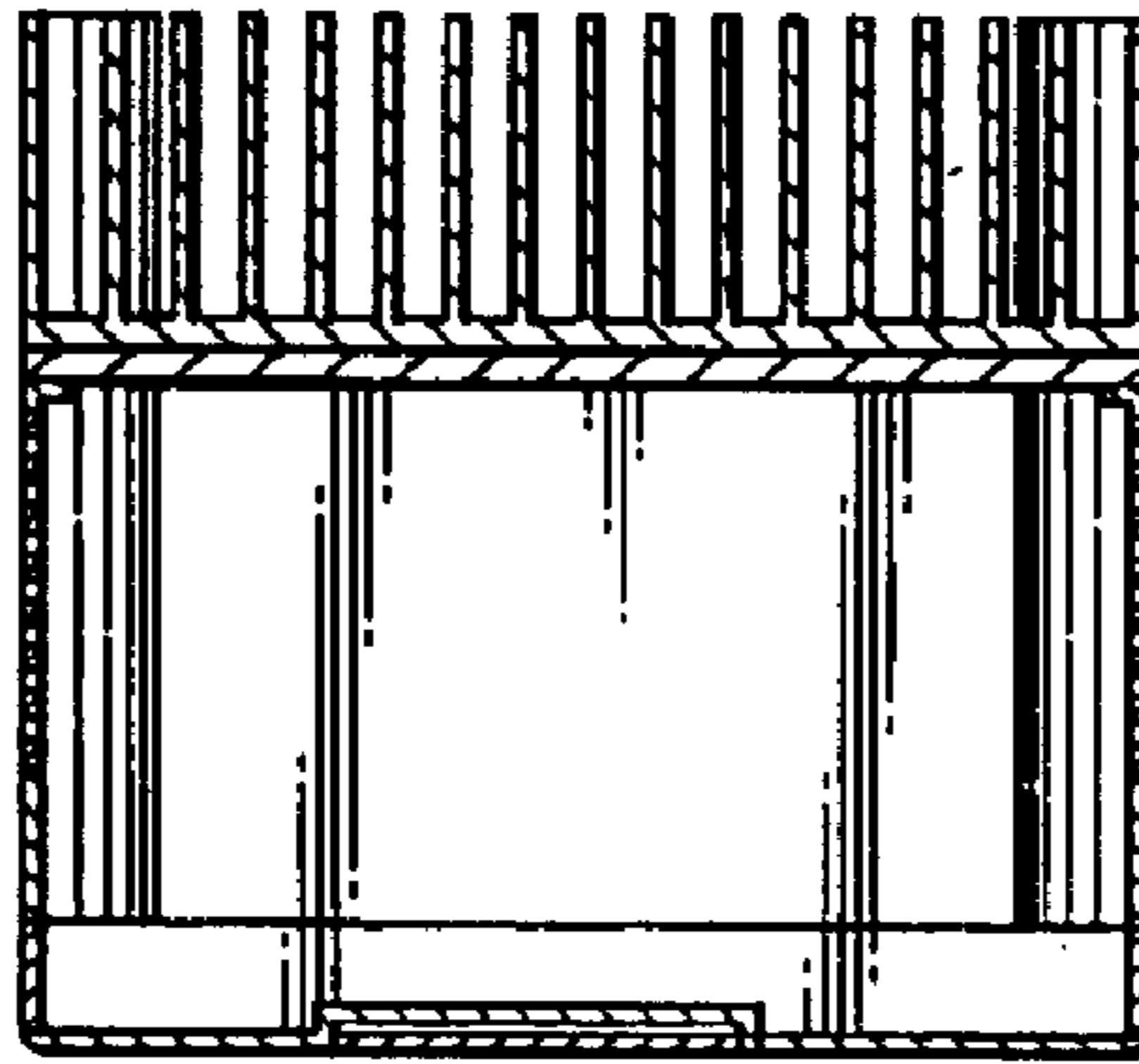

FIG. 9

