

US00D502907S

(12) **United States Design Patent**
Chao

(10) **Patent No.:** **US D502,907 S**
(45) **Date of Patent:** **** Mar. 15, 2005**

- (54) **INSTRUMENT PANEL**
- (76) **Inventor:** **Lance Chao**, 7F, No. 140-1, Jin Hua Street, Taipei (TW)
- (**) **Term:** **14 Years**
- (21) **Appl. No.:** **29/202,502**
- (22) **Filed:** **Apr. 1, 2004**
- (51) **LOC (7) Cl.** **12-16**
- (52) **U.S. Cl.** **D12/192**
- (58) **Field of Search** D12/192; 180/90; 280/750-752; 296/190-191, 70; D10/46, 102, 98, 122-127

- D475,956 S * 6/2003 Juraschek et al. D12/192
- D489,302 S * 5/2004 Tuzar D12/192
- D491,504 S * 6/2004 Sato et al. D12/192

* cited by examiner

Primary Examiner—Stacia Cadmus
(74) *Attorney, Agent, or Firm*—Rosenberg, Klein & Lee

(57) **CLAIM**

The ornamental design for an instrument panel, as shown and described.

DESCRIPTION

FIG. 1 is a perspective view of the instrument panel in accordance with the design;
FIG. 2 is a front elevation view thereof;
FIG. 3 is a rear elevation view thereof;
FIG. 4 is a left side elevation view thereof;
FIG. 5 is a right side elevation view thereof;
FIG. 6 is a top plan view thereof; and,
FIG. 7 is a bottom plan view thereof.

(56) **References Cited**
U.S. PATENT DOCUMENTS

- D54,138 S * 11/1919 Smith D12/192
- D73,347 S * 8/1927 Smith D12/192
- D413,294 S * 8/1999 Lagaay D12/192
- D440,925 S * 4/2001 Pfeiffer D12/192
- D466,062 S * 11/2002 Tsay et al. D12/192

1 Claim, 4 Drawing Sheets

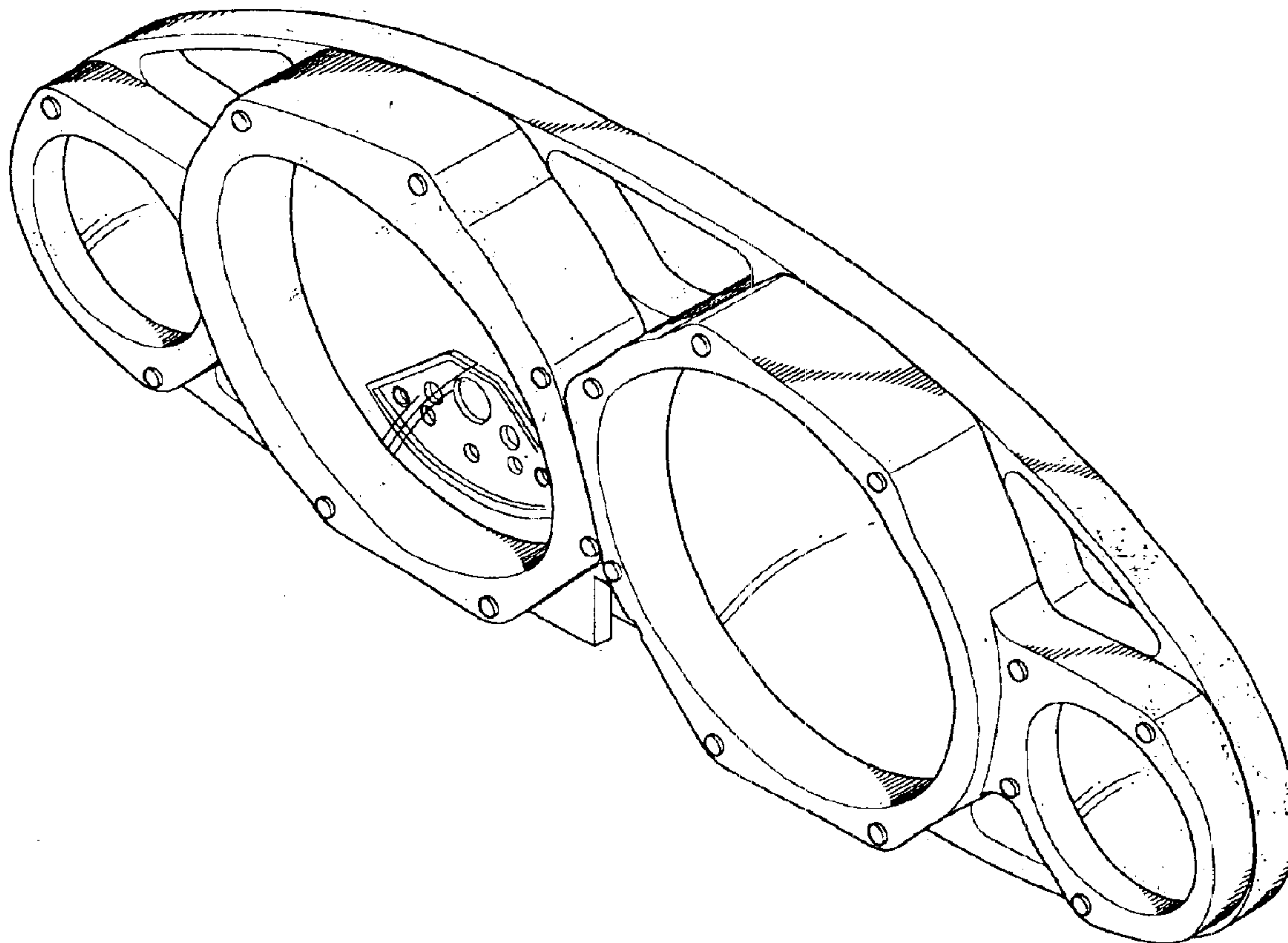

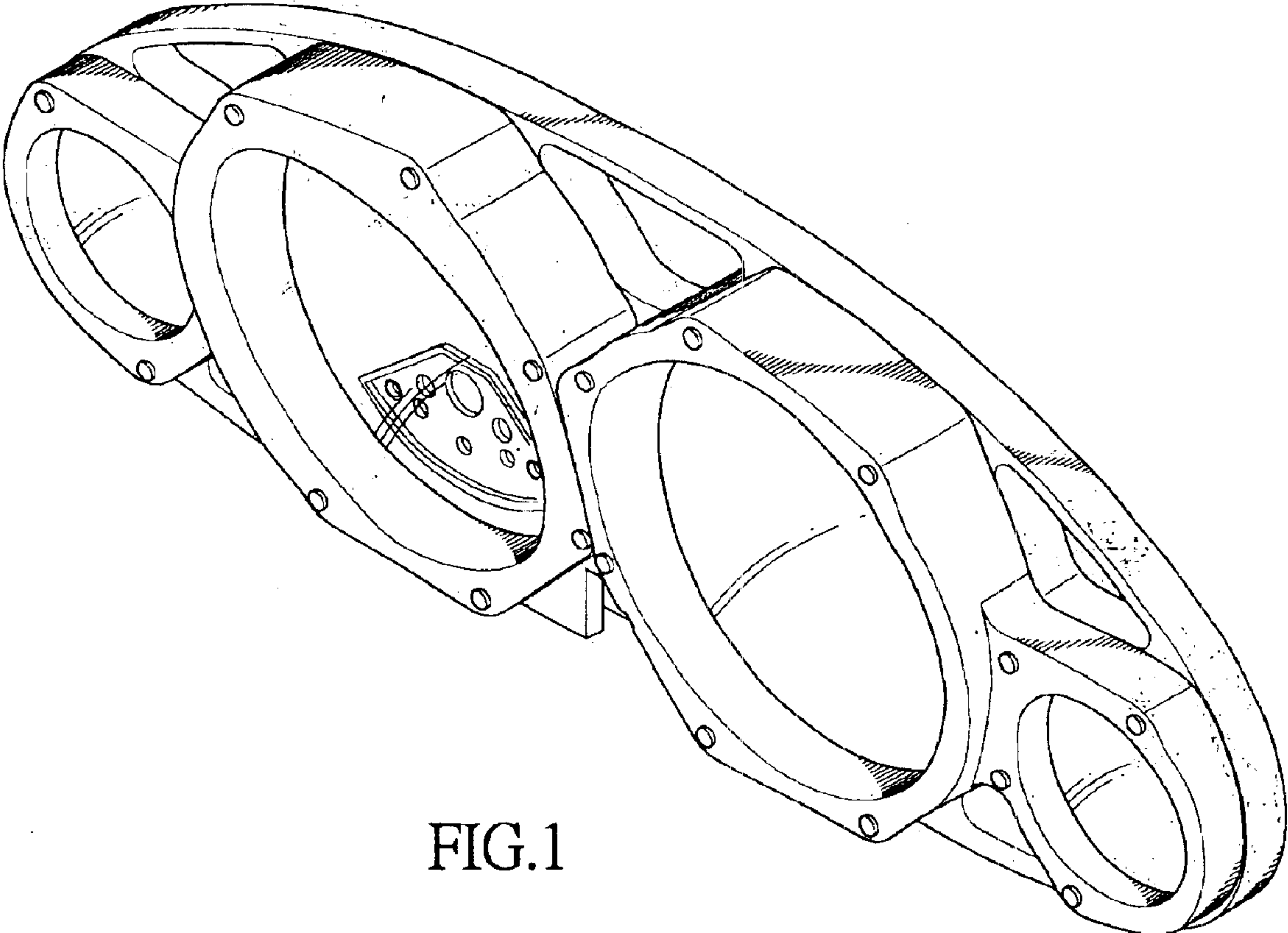

FIG.1

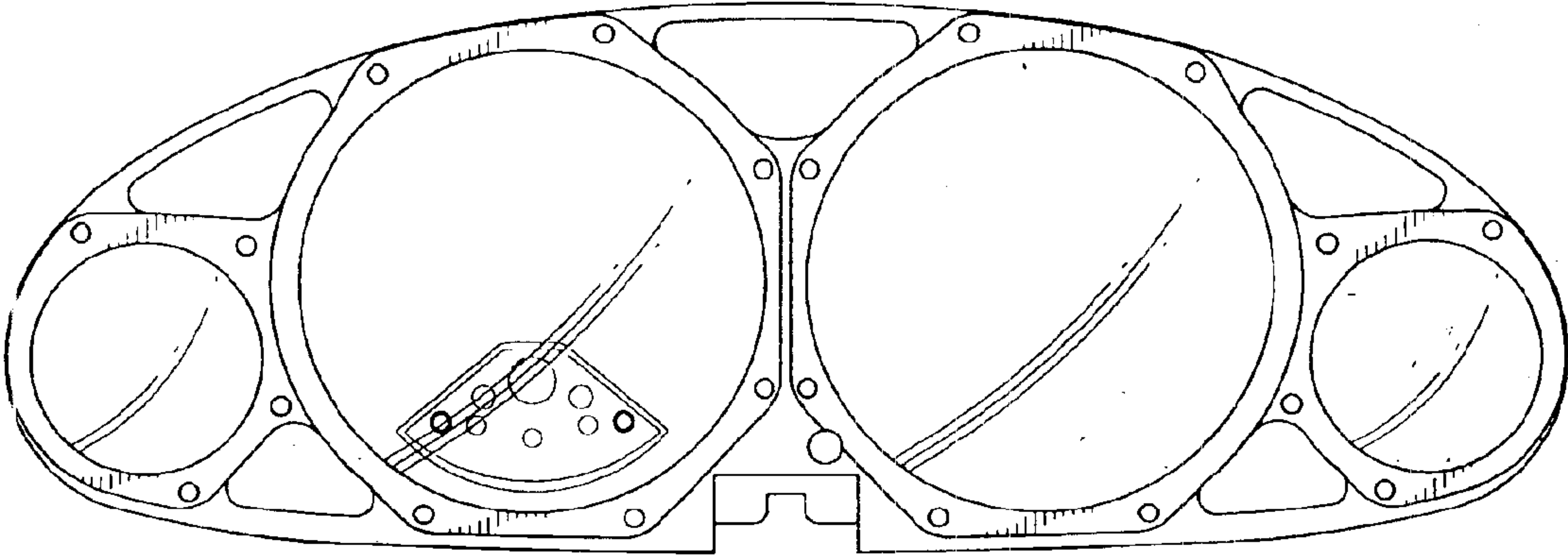

FIG. 2

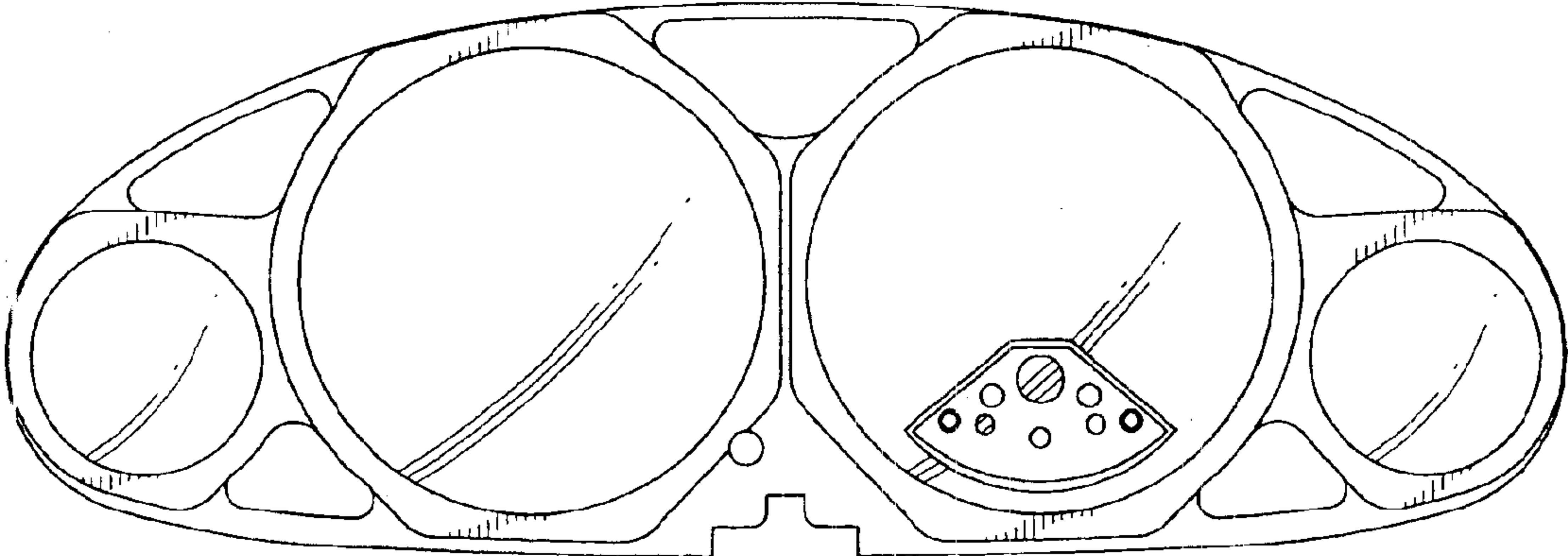

FIG. 3

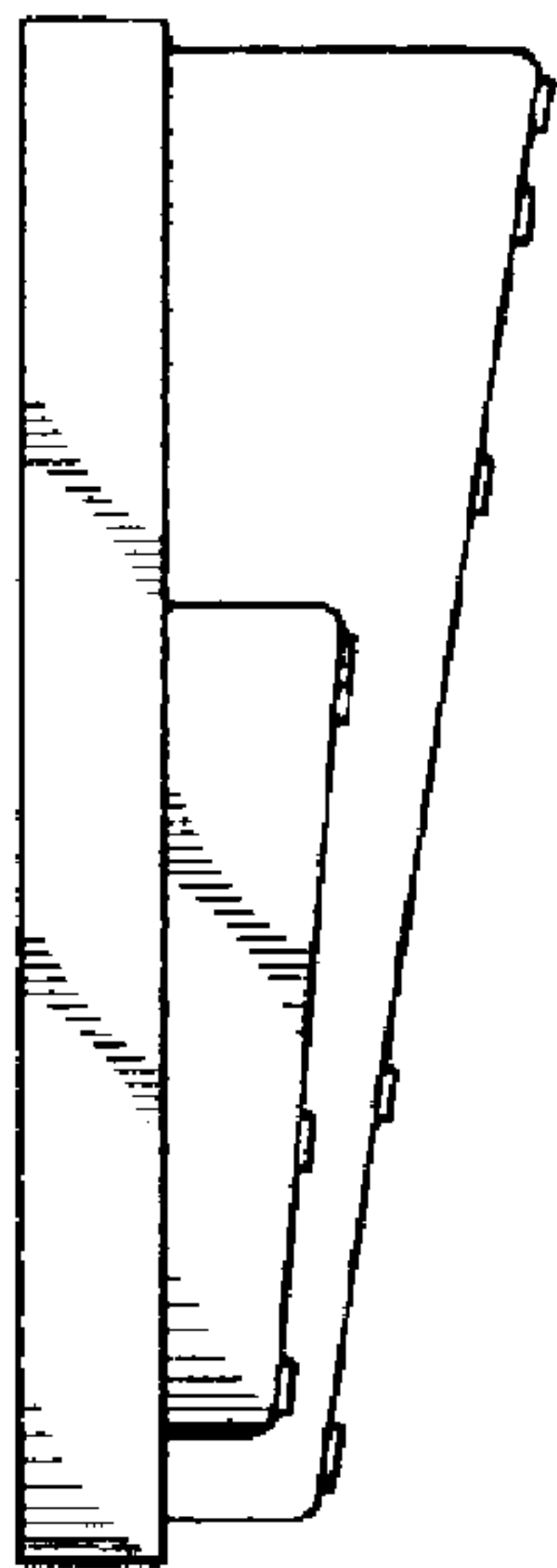

FIG. 4

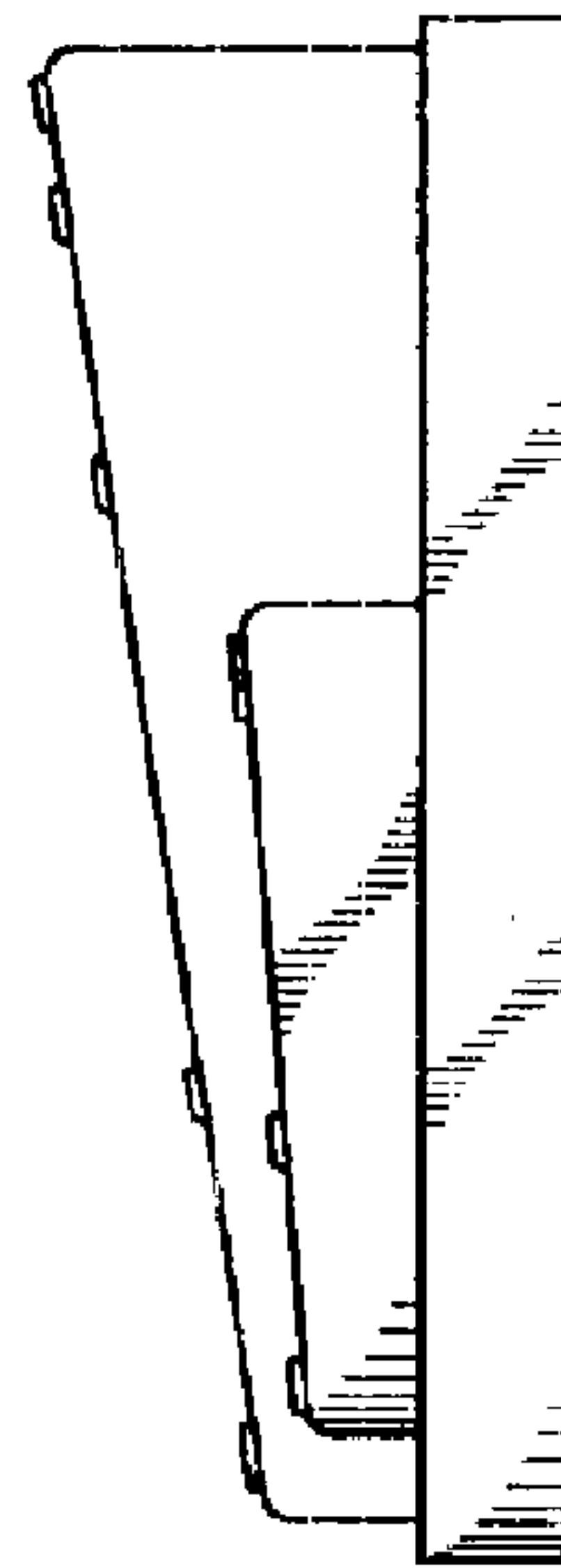

FIG. 5

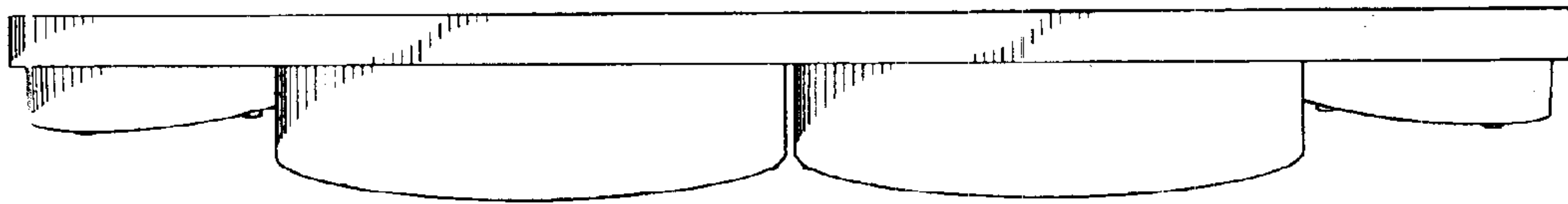

FIG. 6

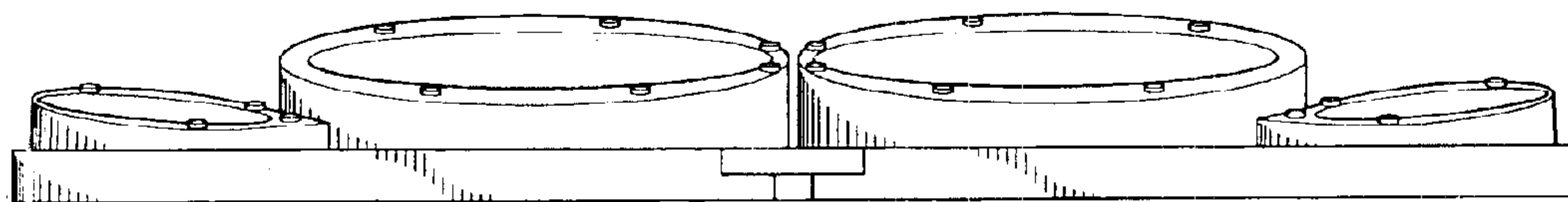

FIG. 7