

US00D502822S

(12) **United States Design Patent**  
**Chandaria**

(10) **Patent No.:** **US D502,822 S**  
(45) **Date of Patent:** **\*\* Mar. 15, 2005**

(54) **DISPLAY UNIT FOR WRAPPING PAPER AND MULTIPLE CARTRIDGE ADHESIVE TAPE USING LINEAR PANEL BACK**

(76) Inventor: **Ashok V. Chandaria, Nairobi (KE)**

(\*\*) Term: **14 Years**

(21) Appl. No.: **29/193,176**

(22) Filed: **Nov. 4, 2003**

**Related U.S. Application Data**

(62) Division of application No. 29/179,445, filed on Apr. 8, 2003, now Pat. No. Des. 488,642.

(51) **LOC (7) Cl.** ..... **06-04**

(52) **U.S. Cl.** ..... **D6/468; D6/469**

(58) **Field of Search** ..... D6/455-469, 473, D6/474; 211/13.1, 45, 60.1, 70.1, 72, 85.18

(56) **References Cited**

**U.S. PATENT DOCUMENTS**

D120,875 S	*	6/1940	Spanel	.....	D6/457
D168,997 S	*	3/1953	Horwitz	.....	D6/399
D202,008 S	*	8/1965	Baker	.....	D6/301
D284,052 S	*	6/1986	Blunden	.....	D6/457
D318,581 S	*	7/1991	DiDomenico	.....	D6/457
D369,034 S	*	4/1996	Davet	.....	D6/457
D412,798 S	*	8/1999	Lewis, Sr.	.....	D6/469
D446,051 S	*	8/2001	Gasmi	.....	D6/455
D468,131 S	*	1/2003	Weichert	.....	D6/454

\* cited by examiner

*Primary Examiner*—Cathron Brooks

(74) *Attorney, Agent, or Firm*—Sand & Seboh

(57) **CLAIM**

The ornamental design for the display unit for wrapping paper and multiple cartridge adhesive tape using linear panel back, as shown and described.

**DESCRIPTION**

FIG. 1 is a perspective view of a first embodiment of the display unit of the present invention;

FIG. 2 is a front elevational view of the display unit shown in FIG. 1;

FIG. 3 is a rear elevational view of the display unit shown in FIG. 1;

FIG. 4 is a left side elevational view of the display unit shown in FIG. 1;

FIG. 5 is a right side elevational view of the display unit shown in FIG. 1;

FIG. 6 is a top view of the display unit shown in FIG. 1;

FIG. 7 is a bottom view of the display unit shown in FIG. 1;

FIG. 8 is a perspective view of a second embodiment of the display unit shown with complementary shaped holes formed in the display board for receiving product;

FIG. 9 is a front elevational view of the display unit shown in FIG. 8;

FIG. 10 is a rear elevational view of the display unit shown in FIG. 8;

FIG. 11 is a left side elevational view of the display unit shown in FIG. 8;

FIG. 12 is a right side elevational view of the display unit shown in FIG. 8;

FIG. 13 is a top view of the display unit shown in FIG. 8;

FIG. 14 is a bottom view of the display unit shown in FIG. 8;

FIG. 15 is a perspective view of a third embodiment of the present invention shown with product suspended from hooks off of the display board;

FIG. 16 is a front elevational view of the display unit shown in FIG. 15;

FIG. 17 is a rear elevational view of the display unit shown in FIG. 15;

FIG. 18 is a left side elevational view of the display unit shown in FIG. 15;

FIG. 19 is a right side elevational view of the display unit shown in FIG. 15;

FIG. 20 is a top view of the display unit shown in FIG. 15; and,

FIG. 21 is a bottom view of the display unit shown in FIG. 15.

**1 Claim, 21 Drawing Sheets**

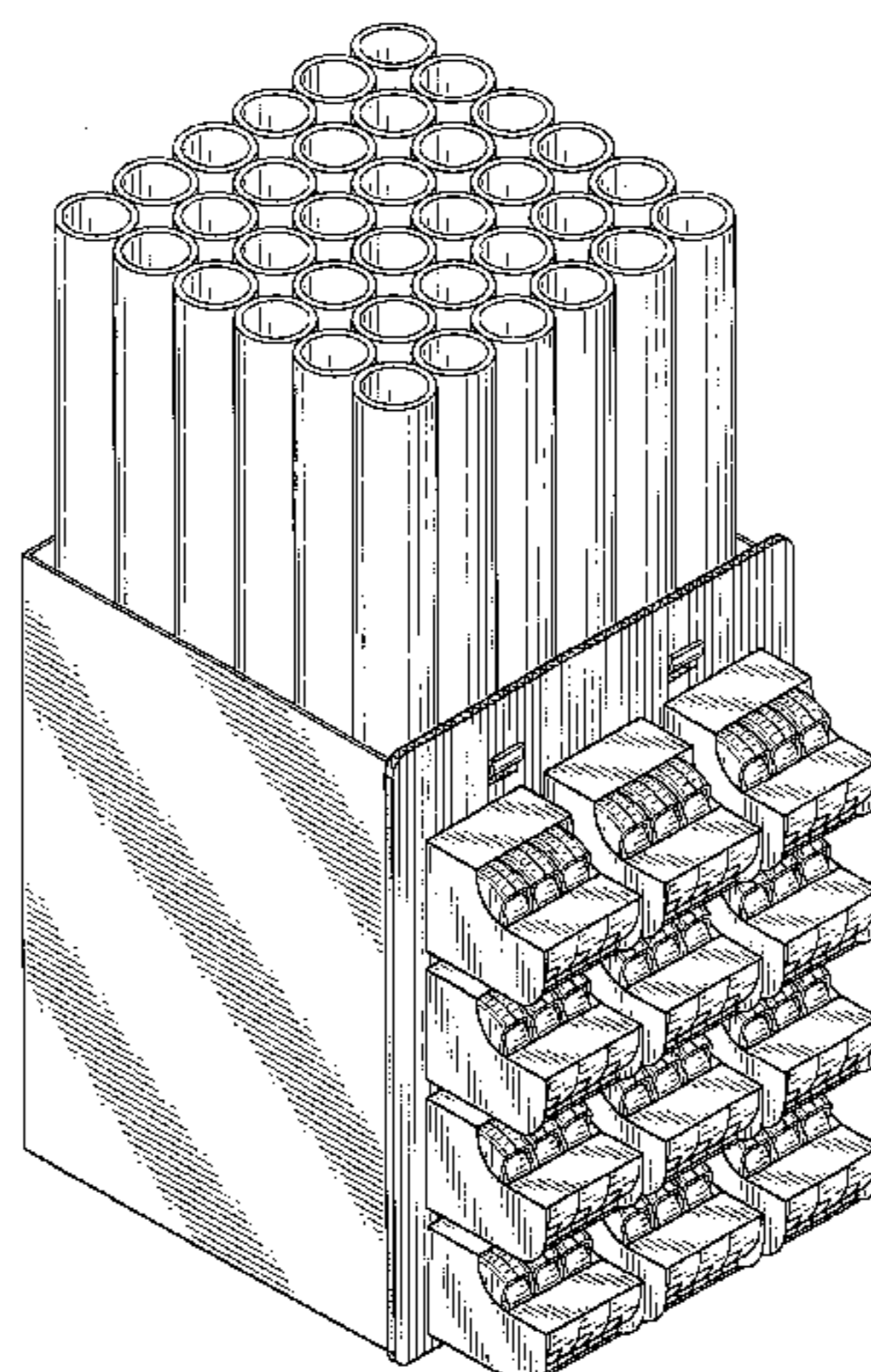

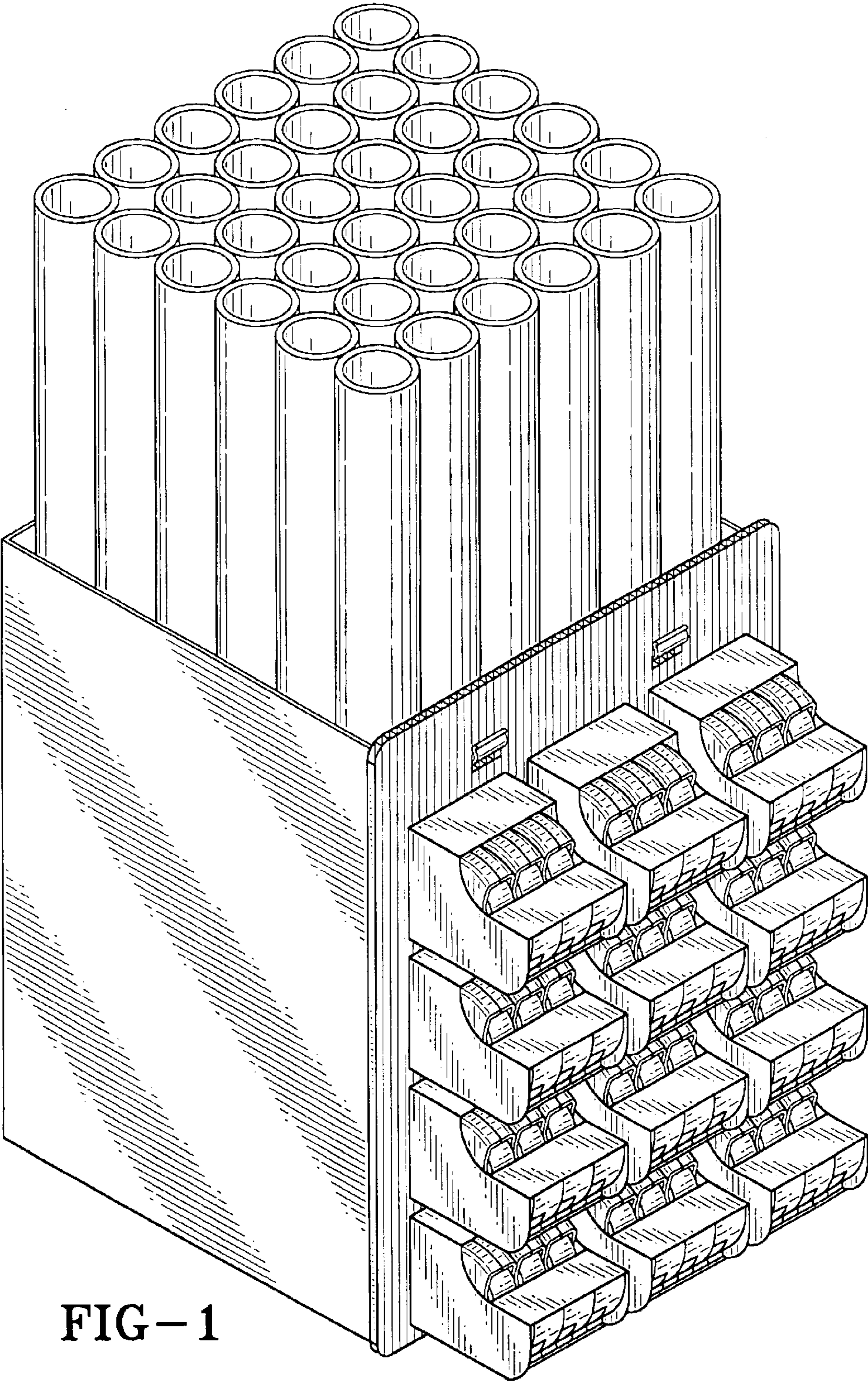

FIG-1

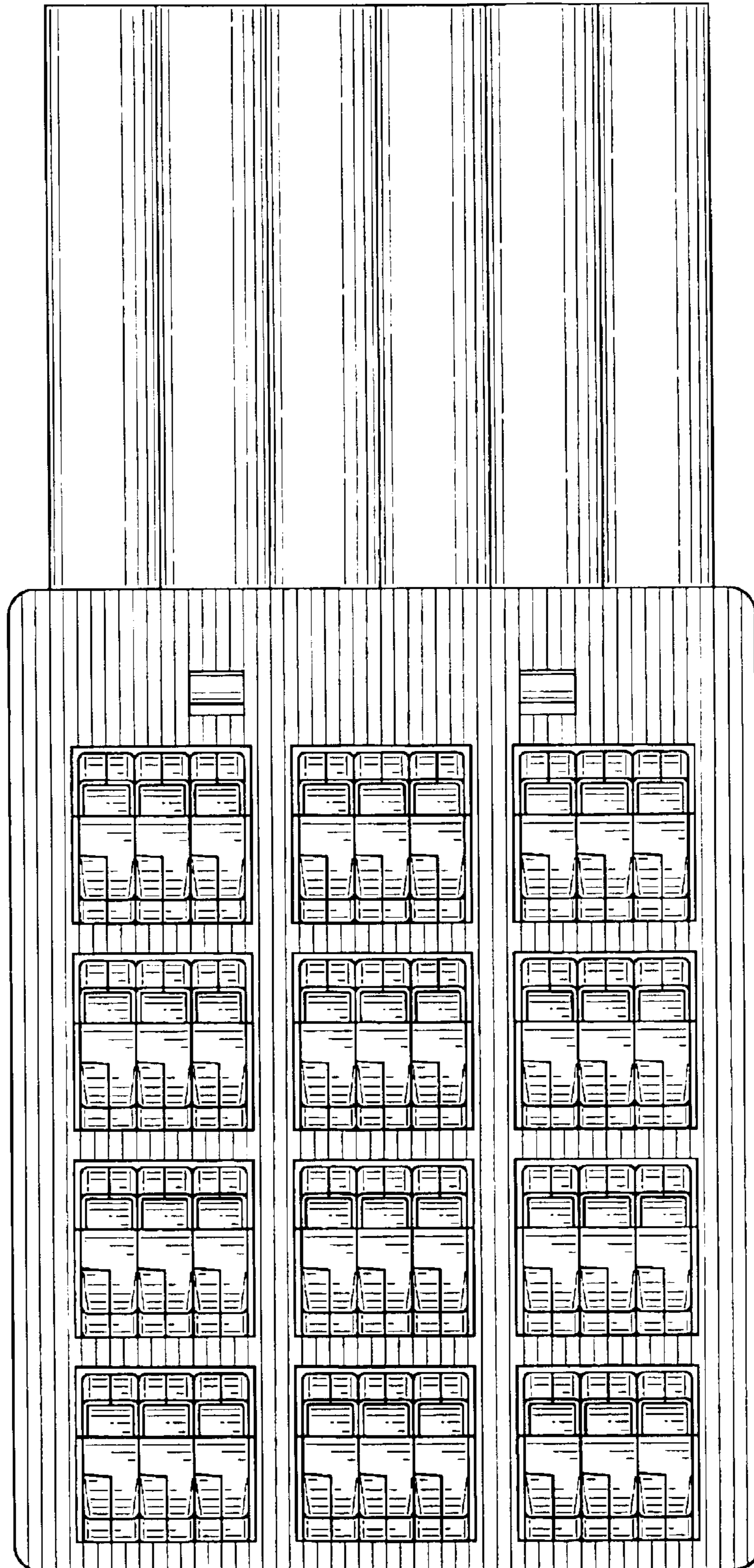

FIG-2

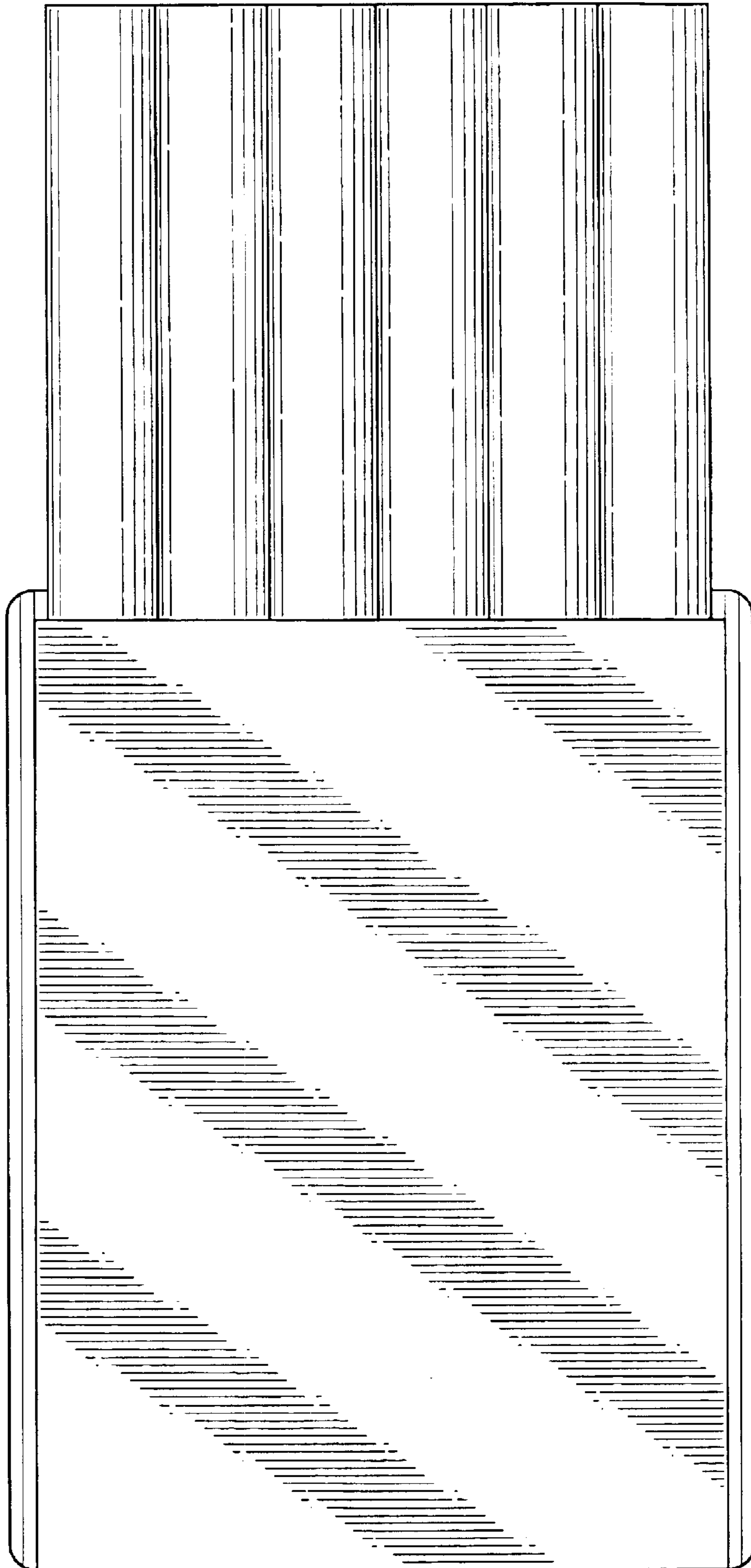

FIG-3

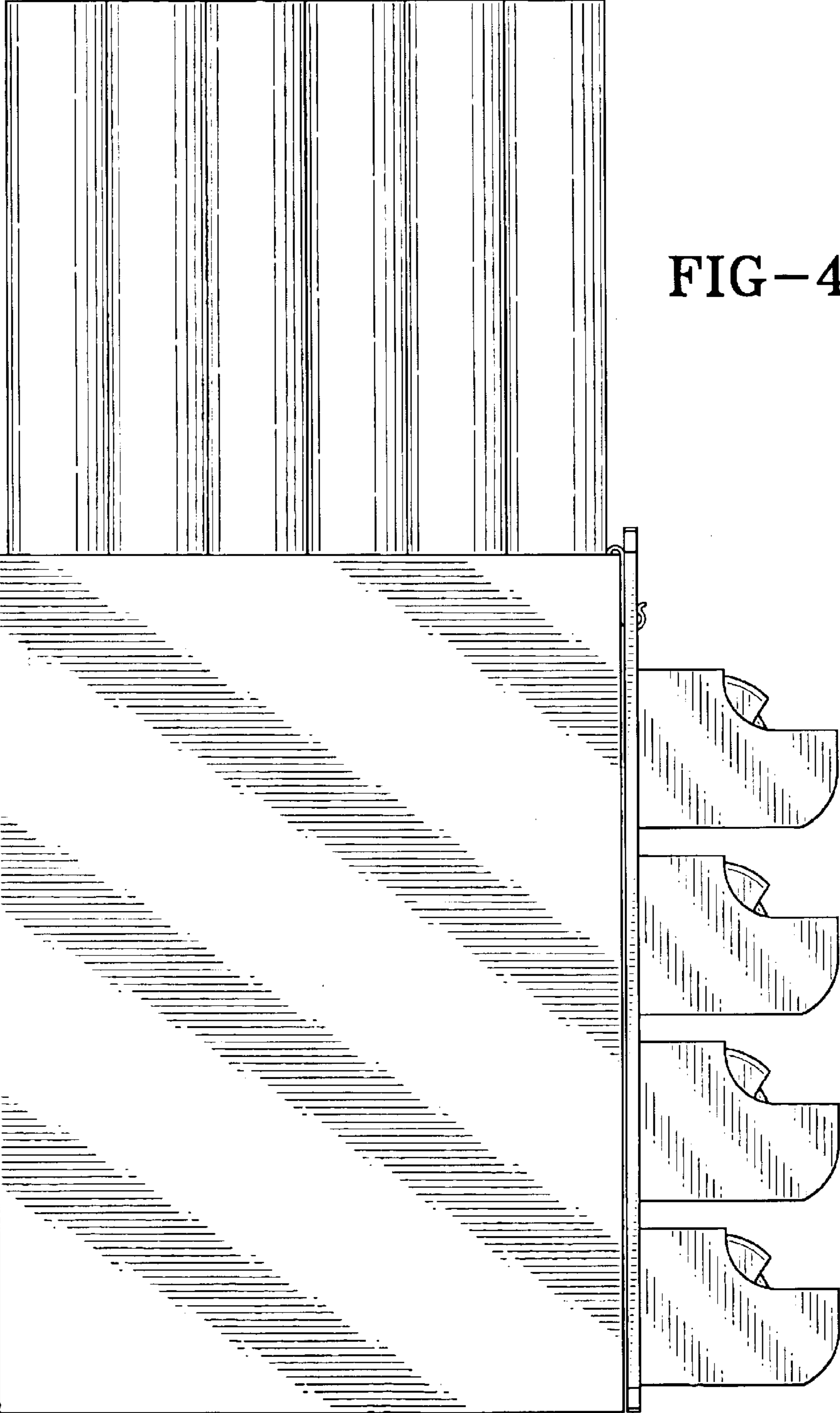
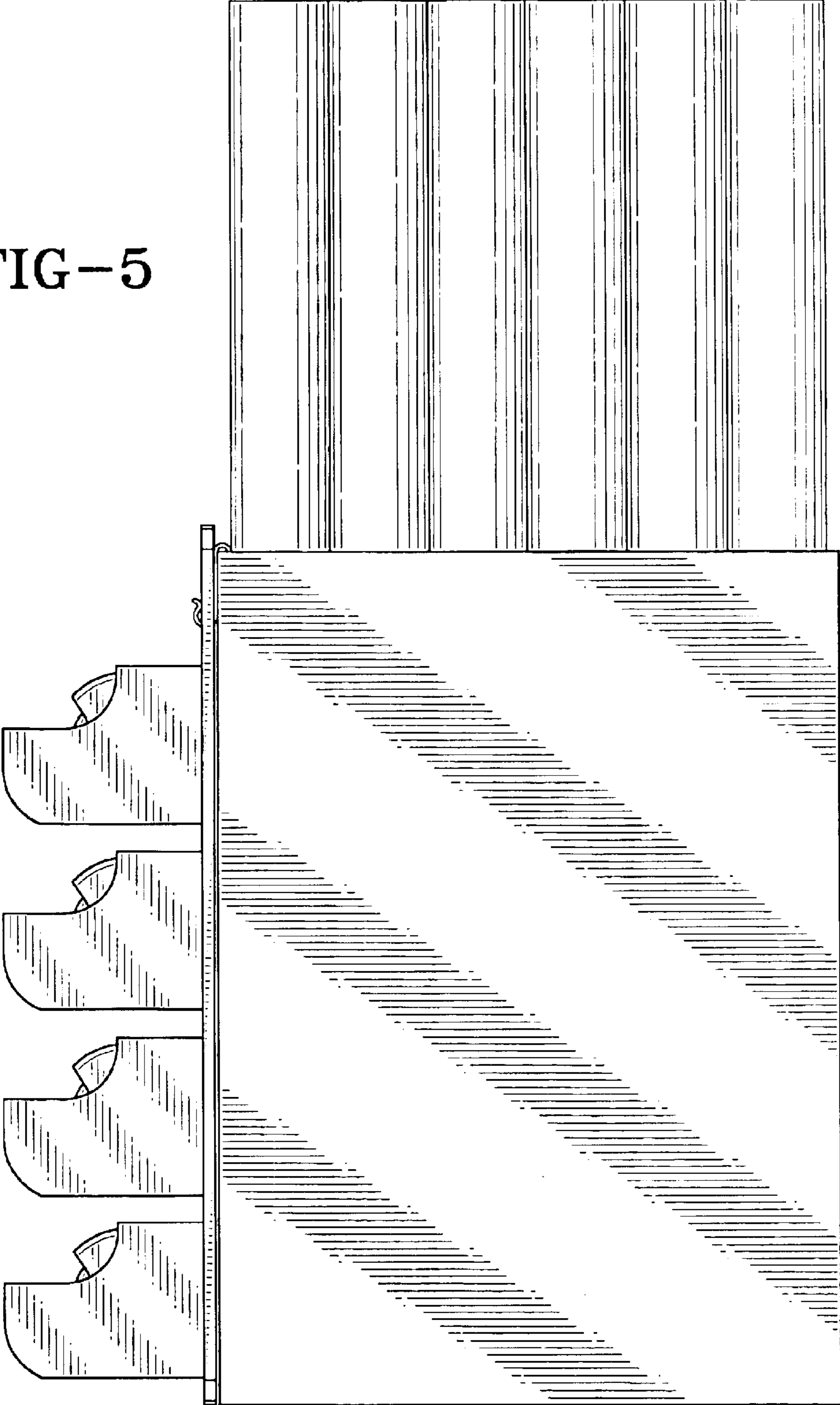

FIG-4

FIG-5



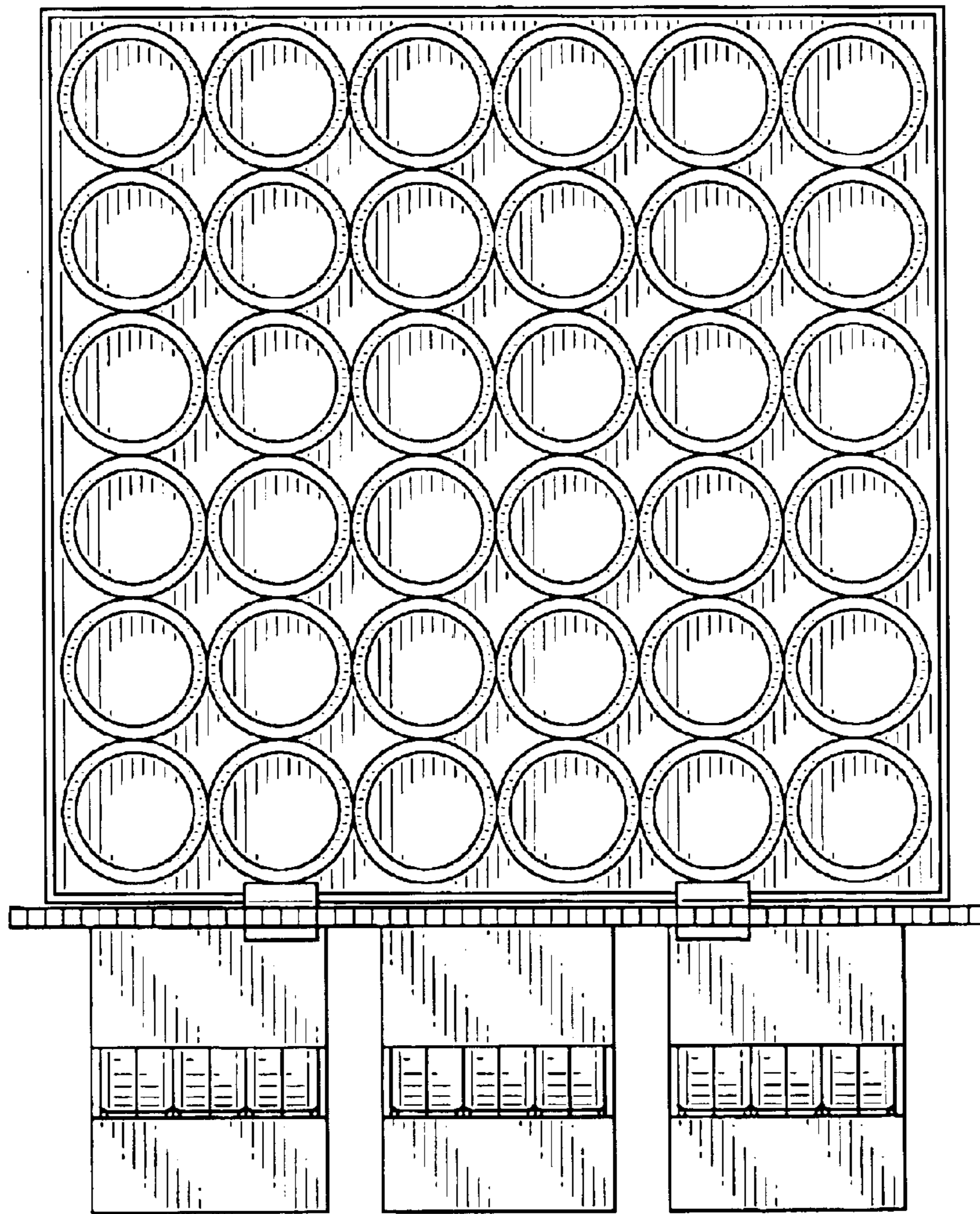

FIG-6

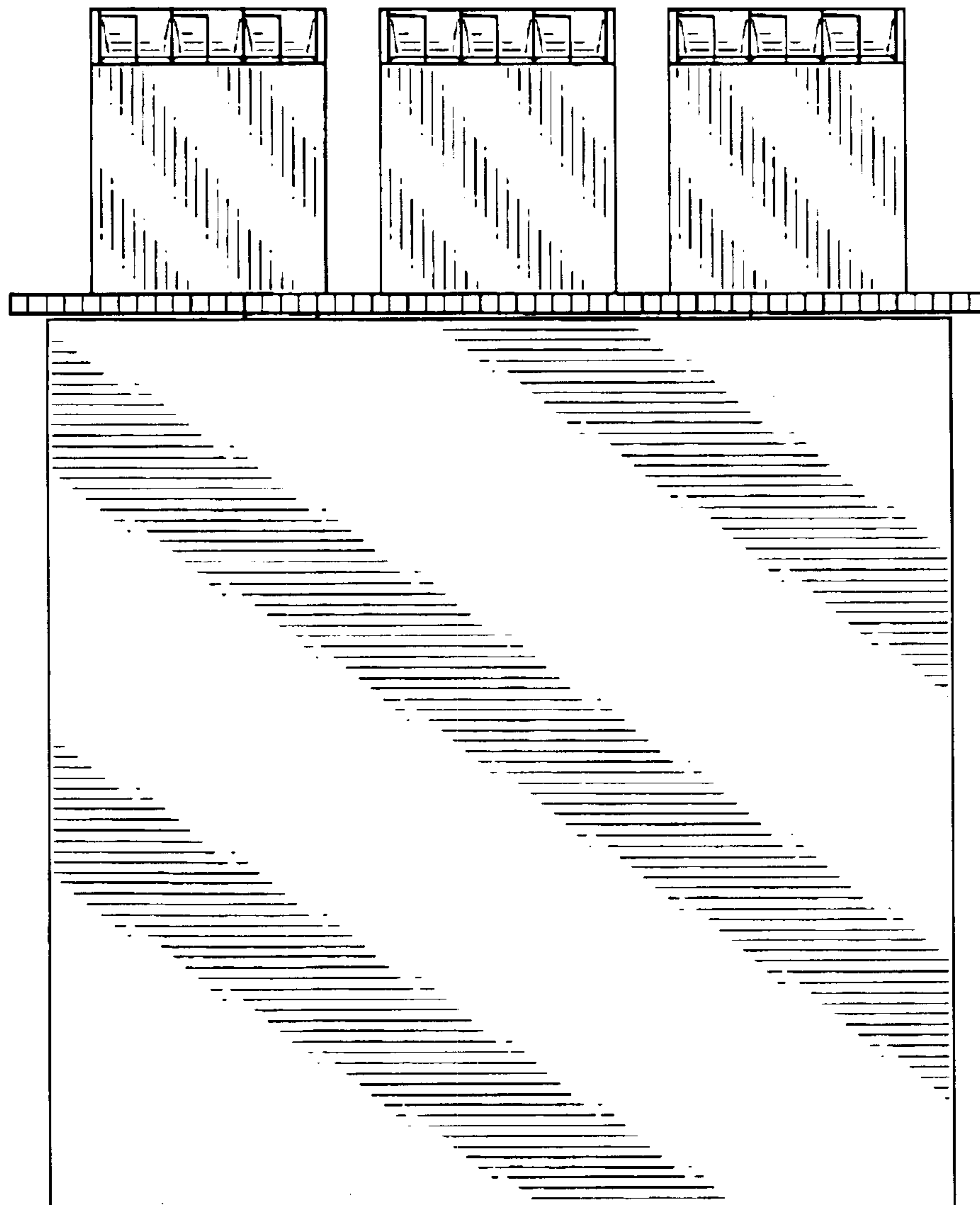

FIG-7



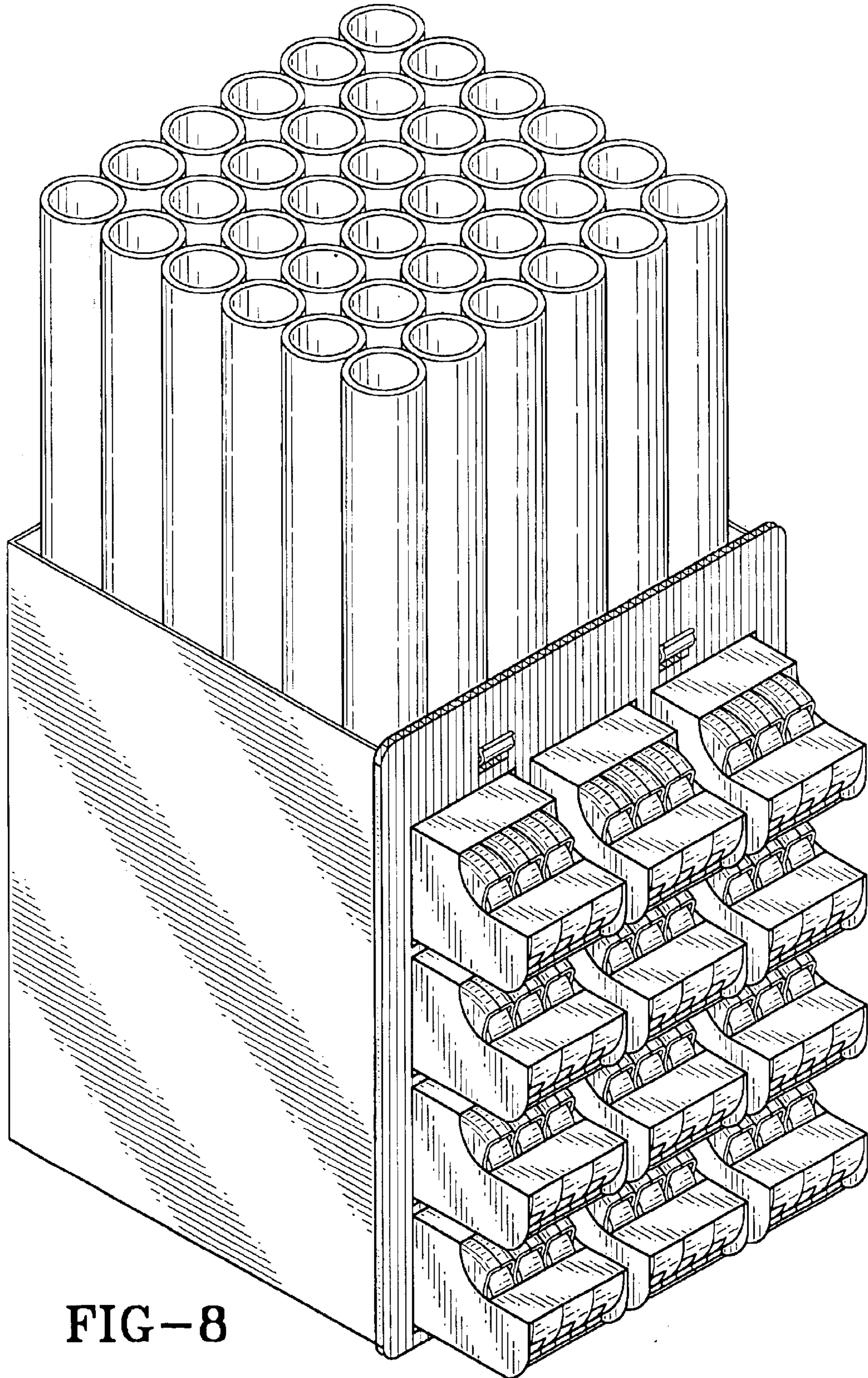

FIG-8

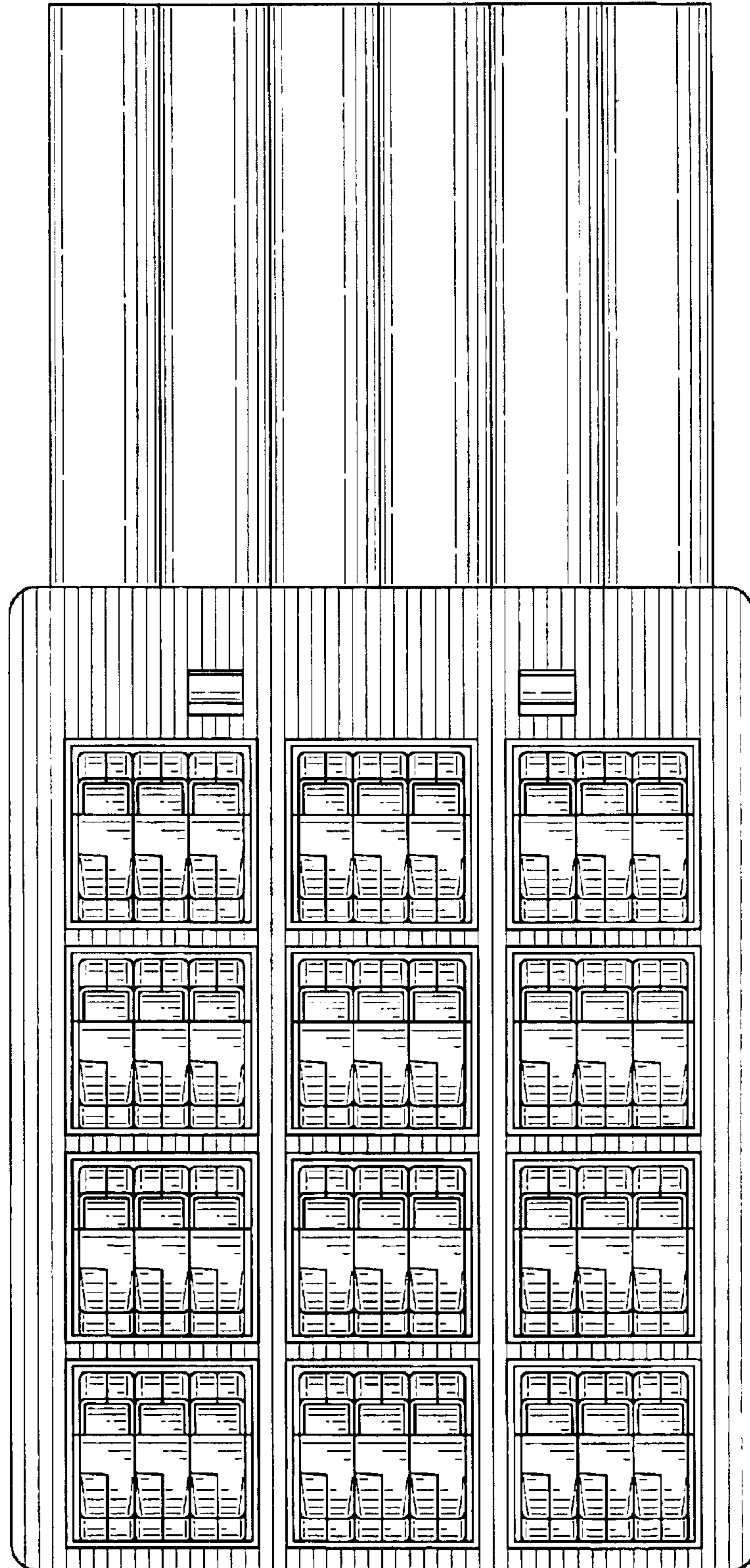

FIG-9

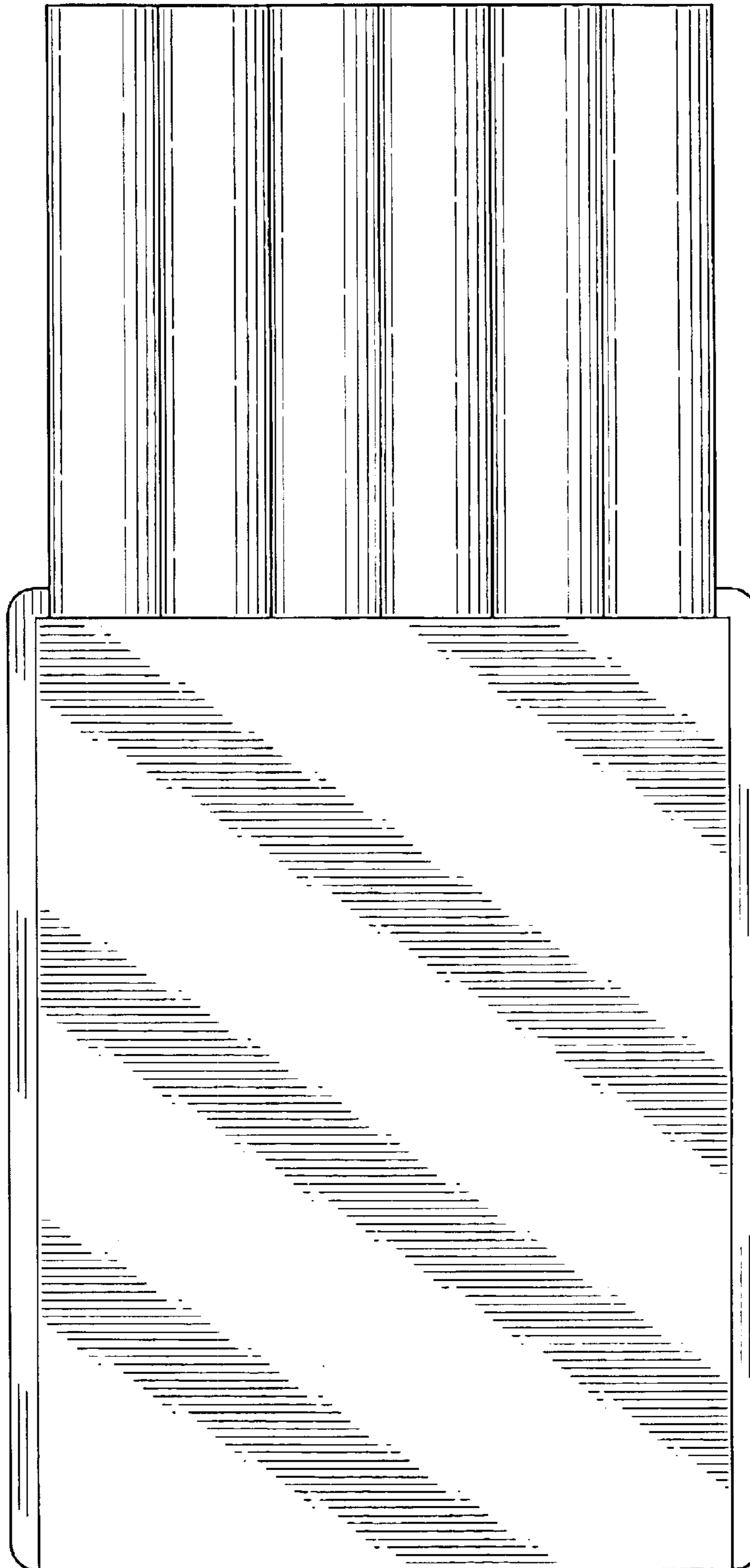

FIG-10

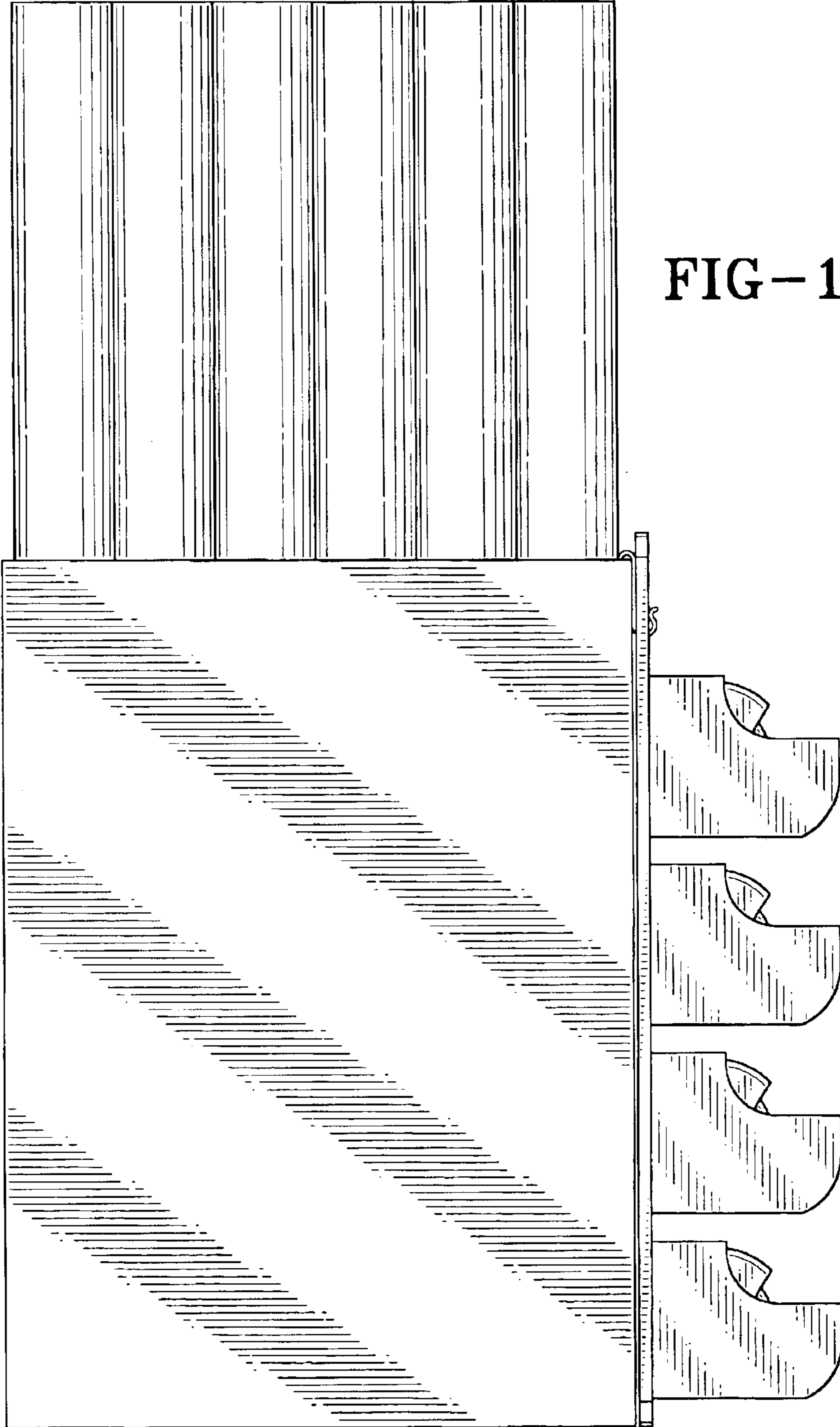
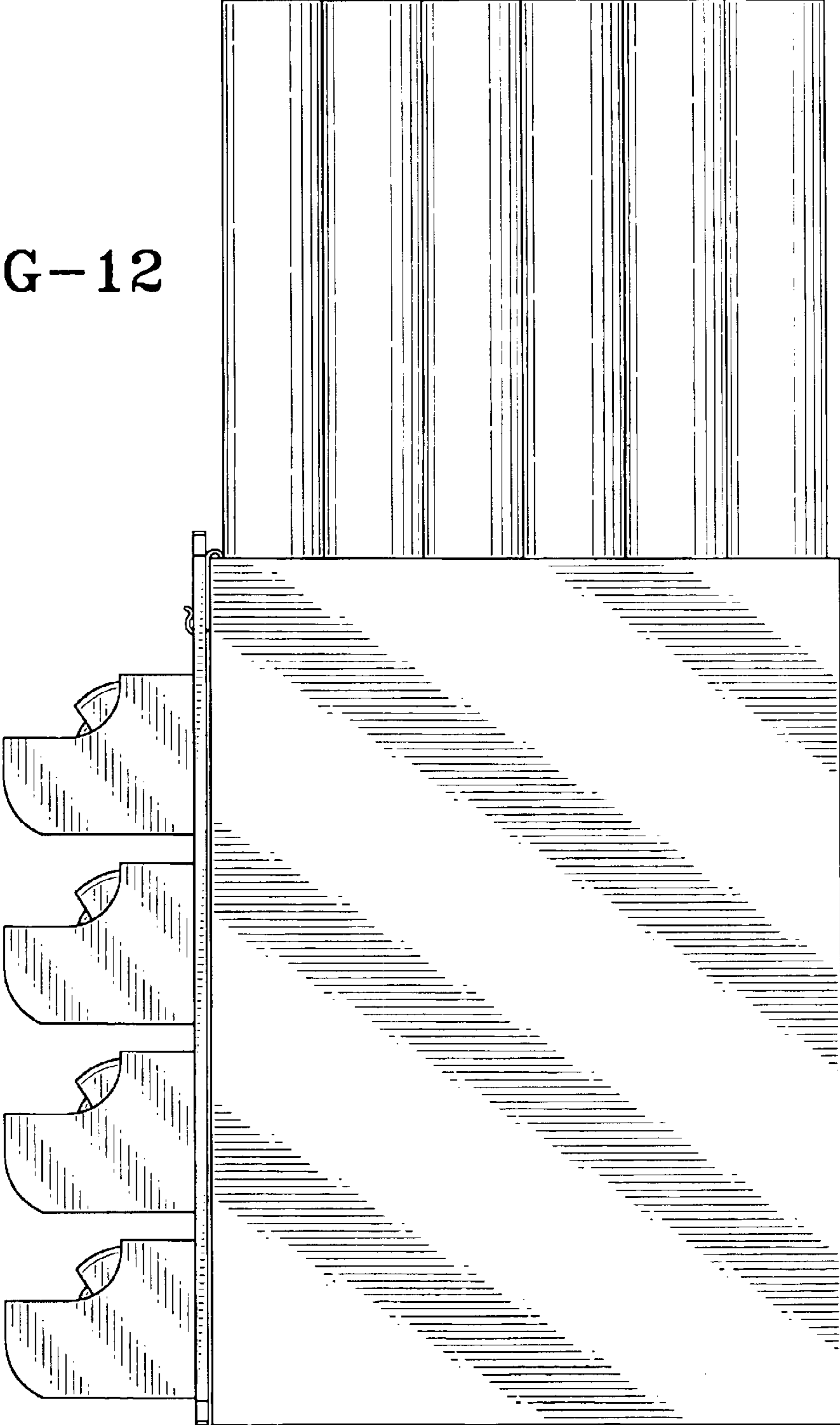

FIG-11

FIG-12



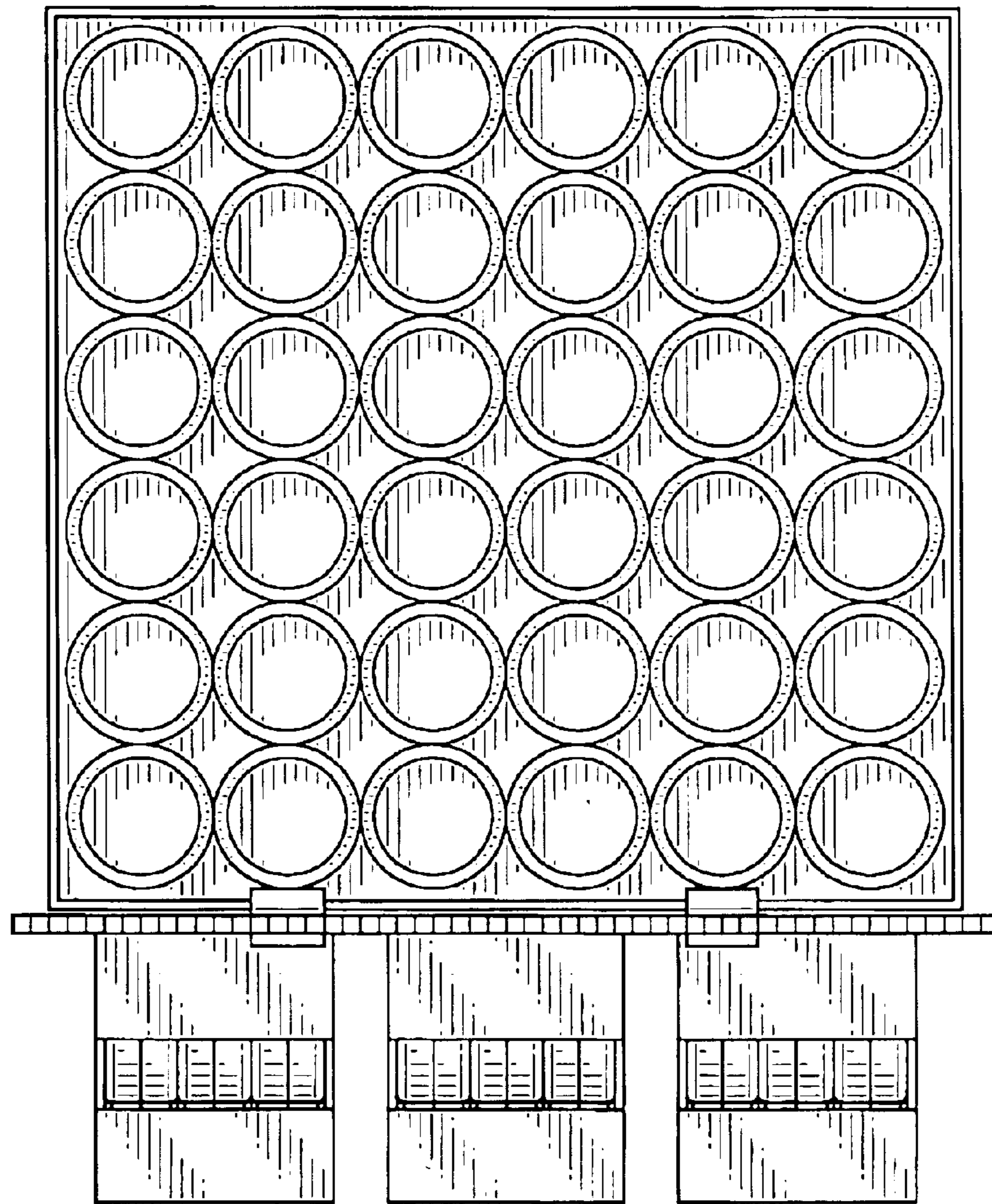

FIG-13

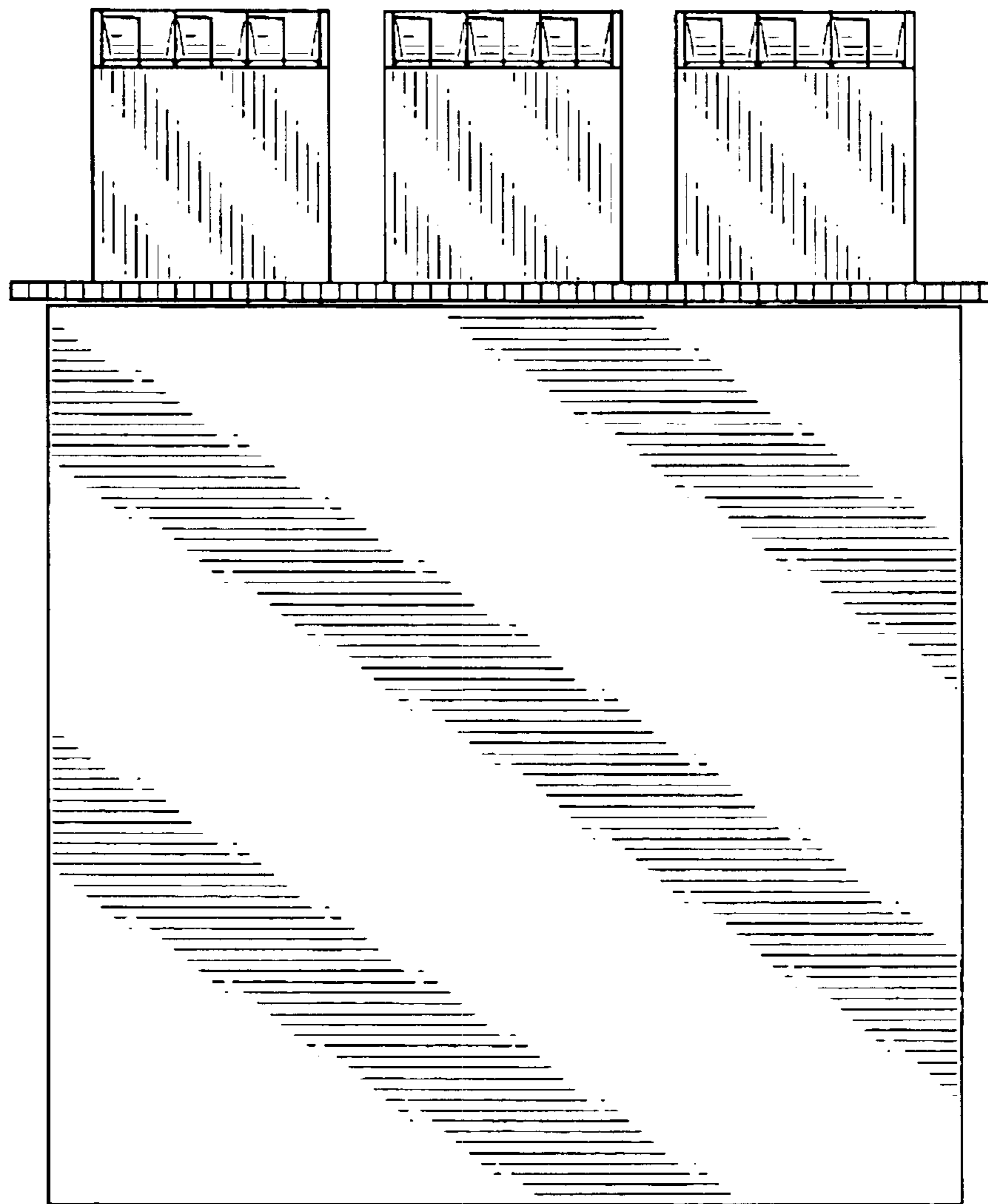

FIG-14

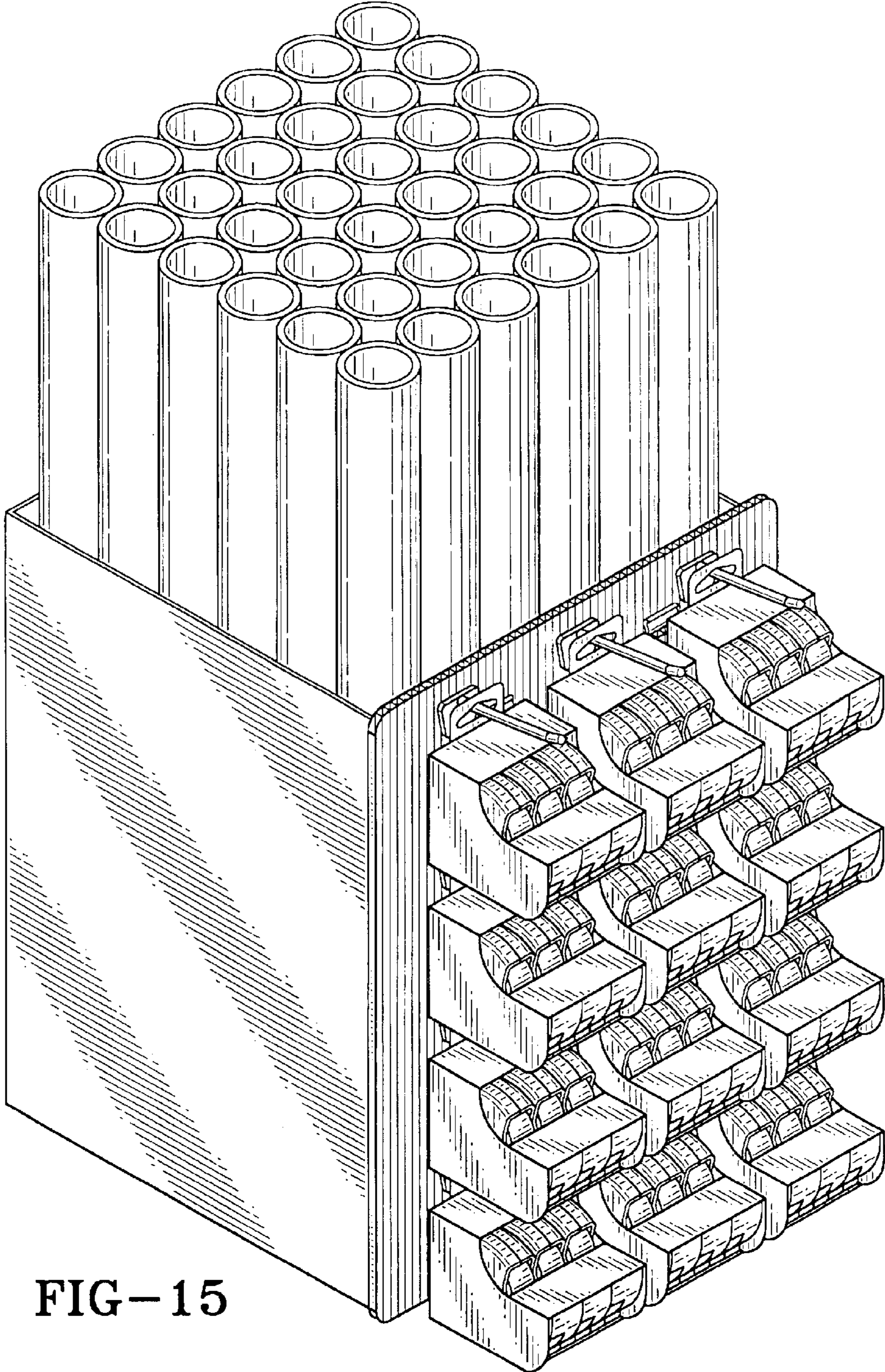

FIG-15



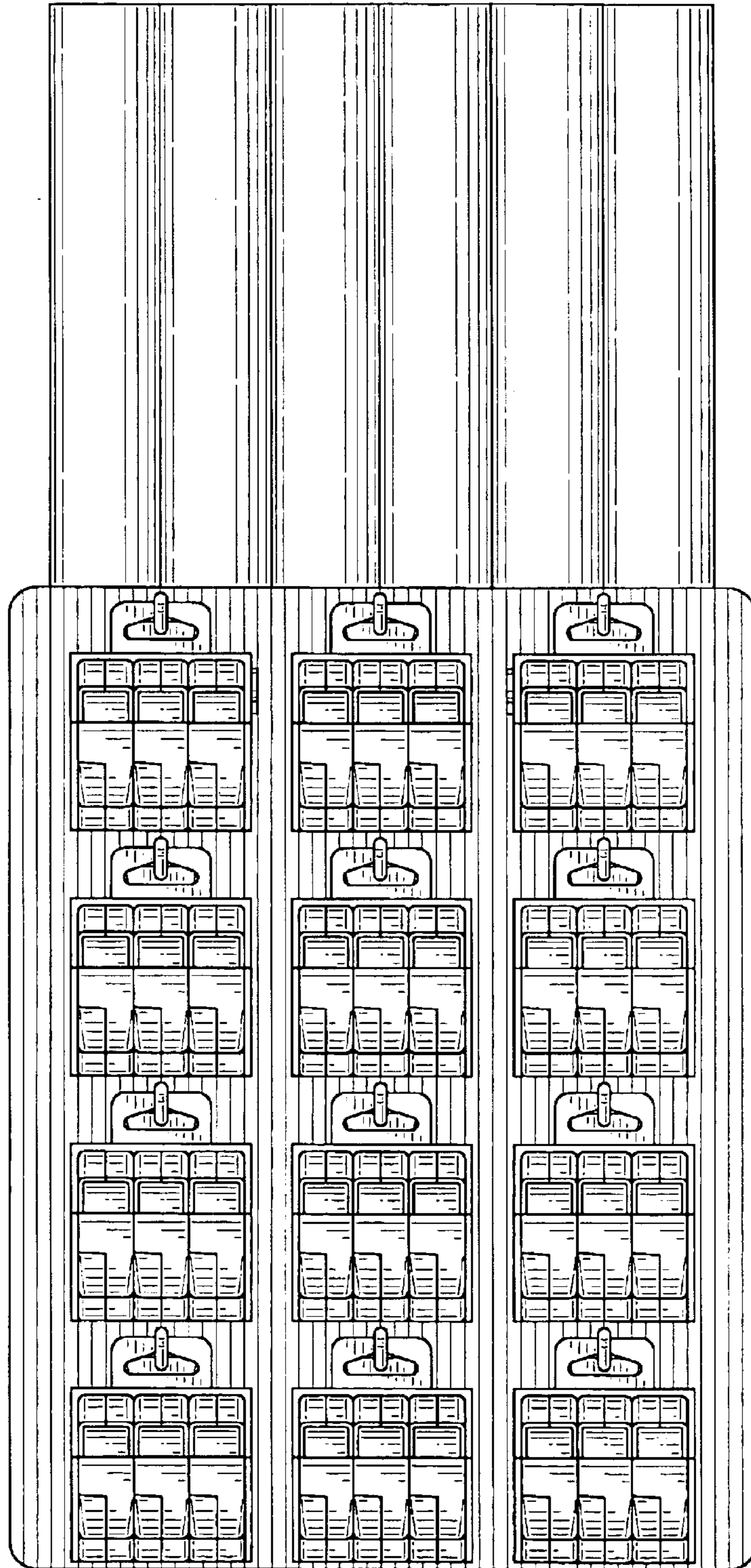

FIG-16

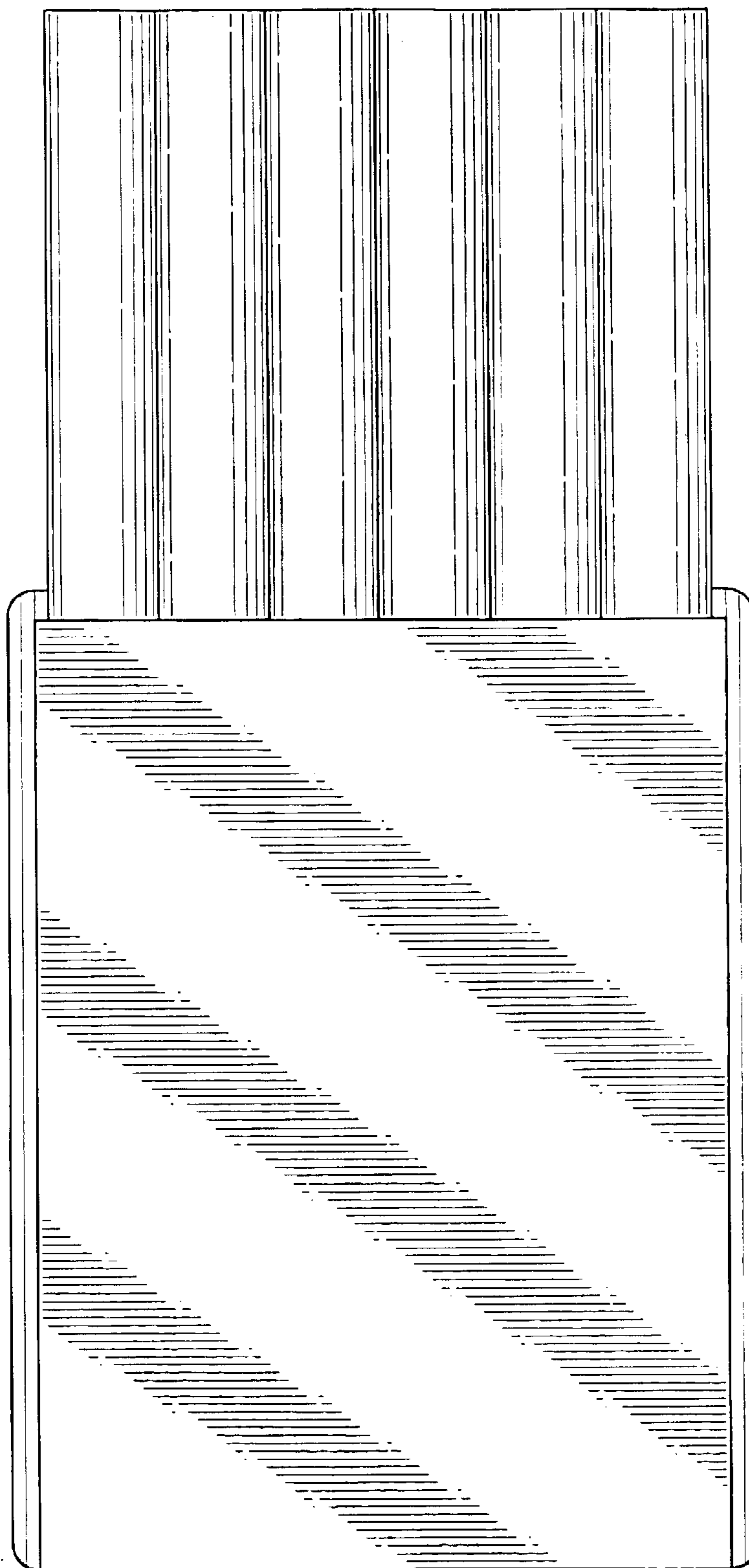

FIG-17

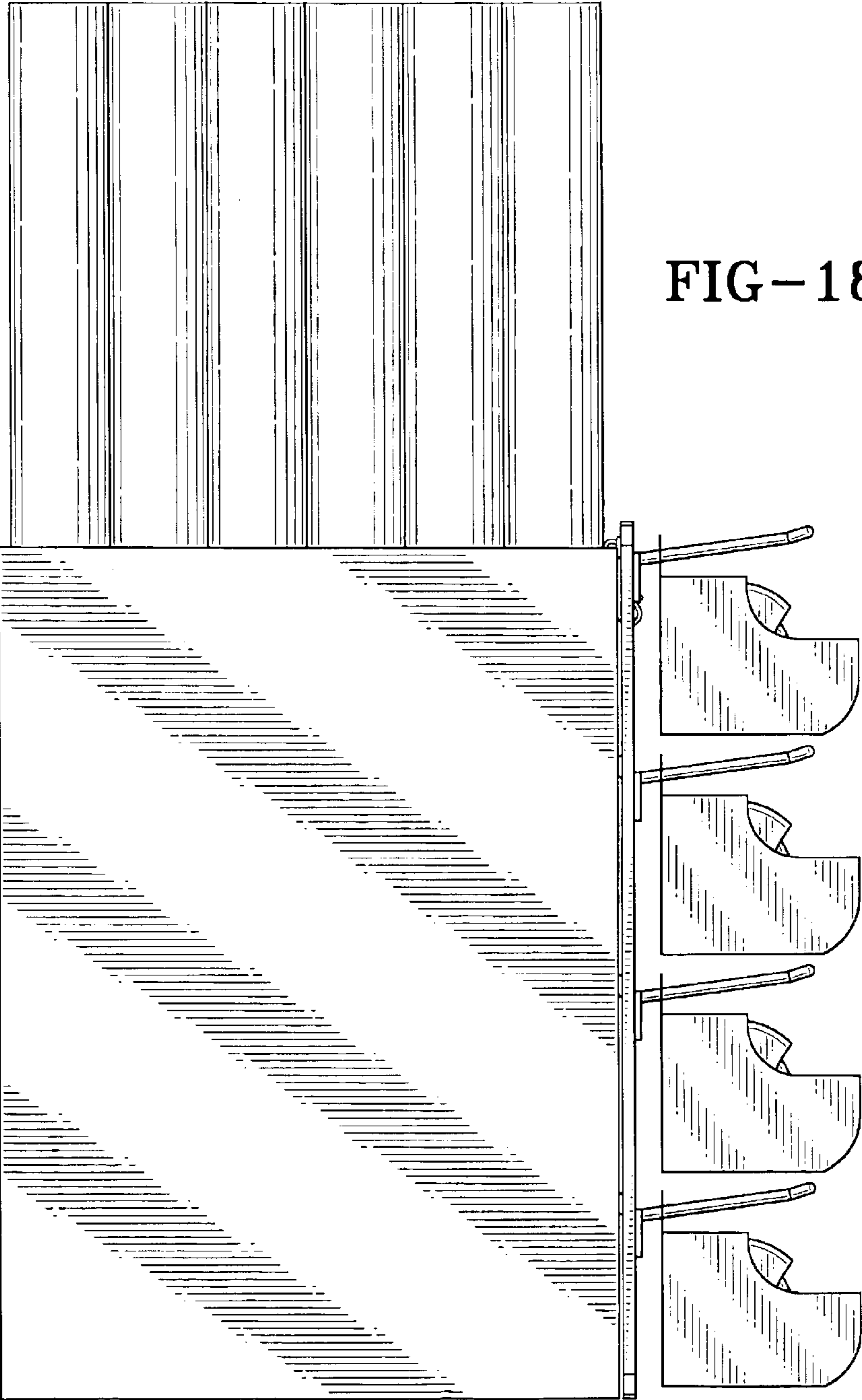
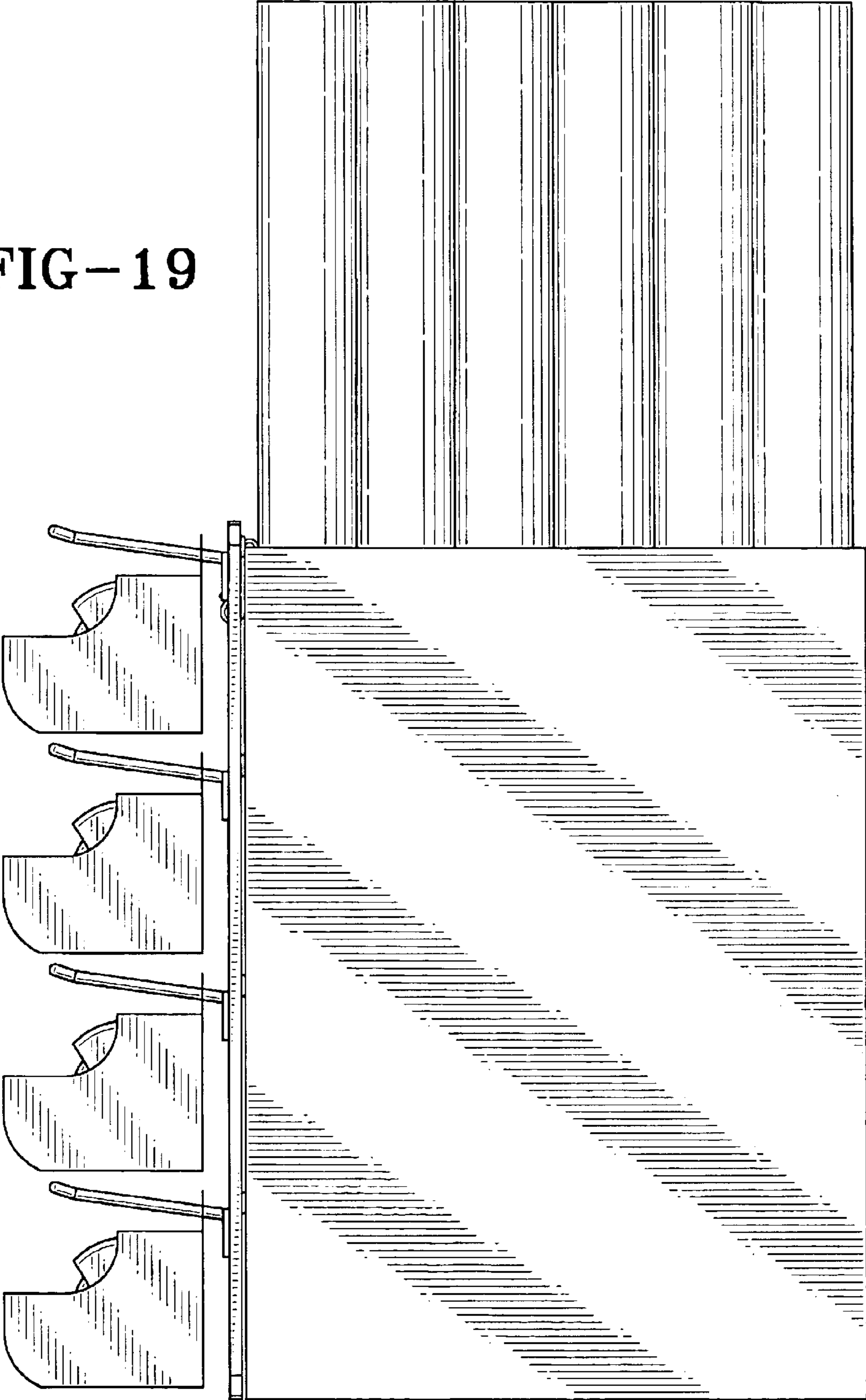

FIG-18

FIG-19



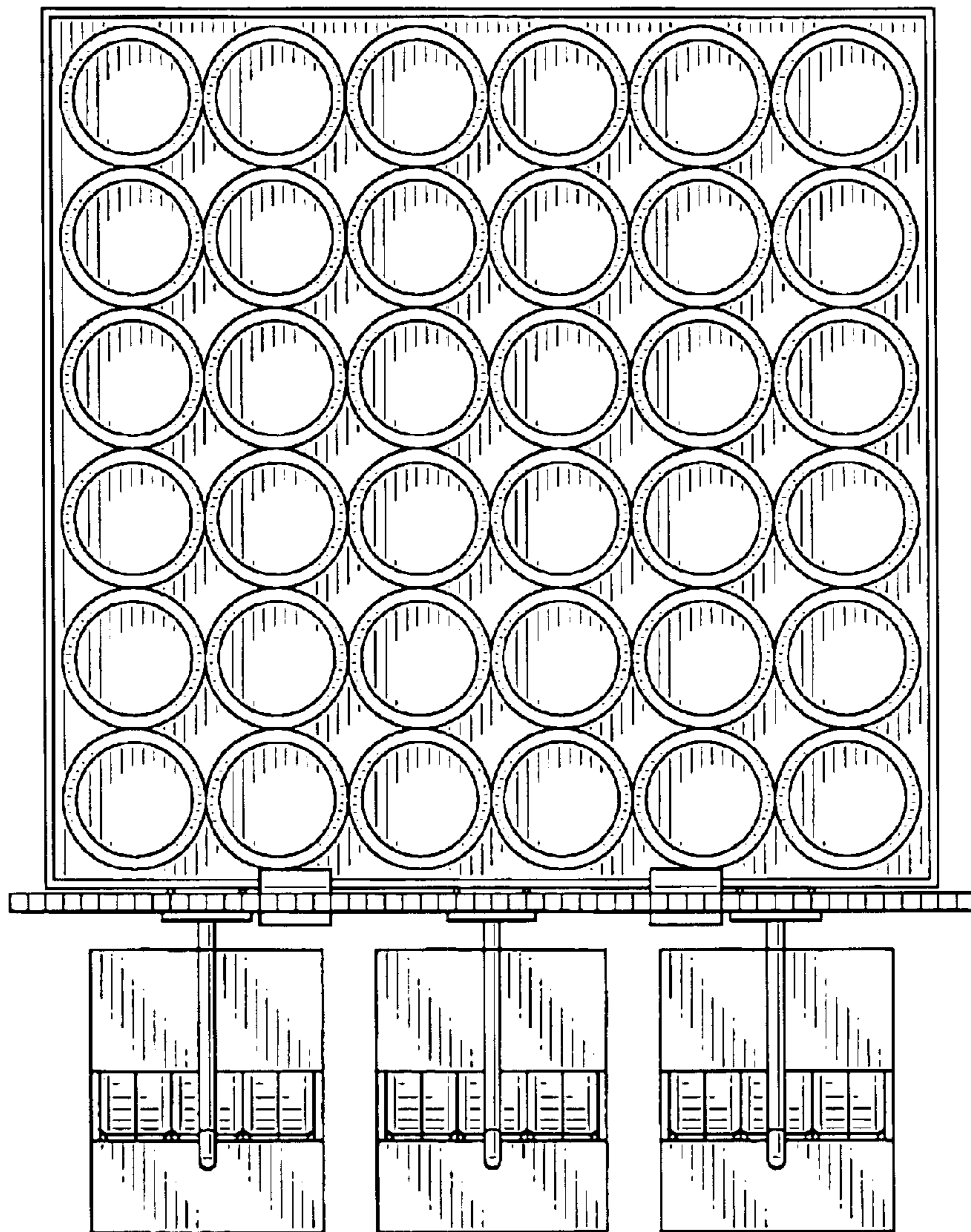

FIG-20

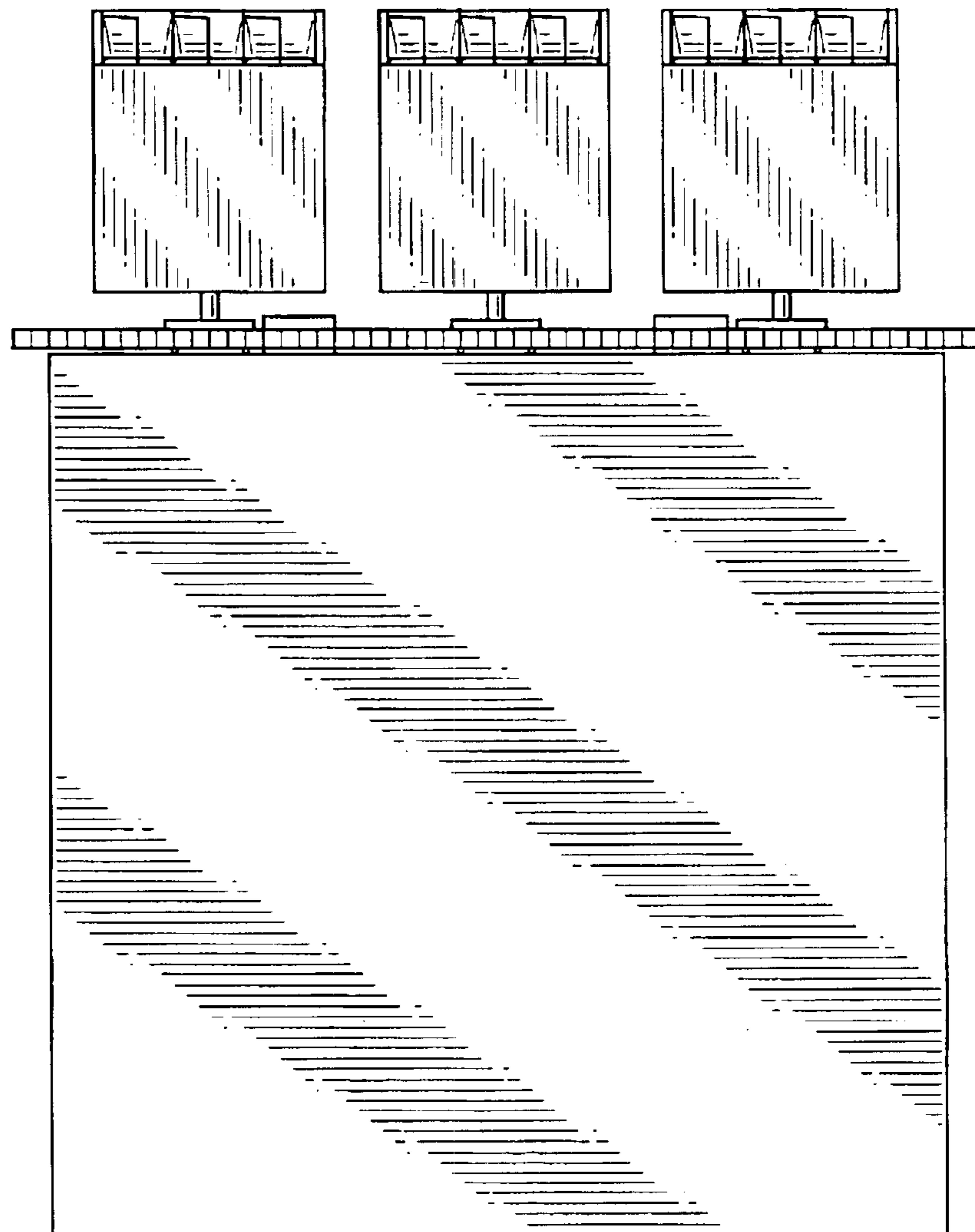

FIG-21