

US00D502782S

(12) **United States Design Patent**  
**Tang**

(10) **Patent No.:** **US D502,782 S**  
(45) **Date of Patent:** **\*\* Mar. 8, 2005**

(54) **COCKTAIL LAMP**

(76) **Inventor:** **Vung Kong Tang**, 3E, Hua Ting Xuan,  
Shi Dai Hua Ting, Xin Zhou Road Fu  
Tian District, Shenzhen (CN)

(\*\*) **Term:** **14 Years**

(21) **Appl. No.:** **29/192,741**

(22) **Filed:** **Oct. 30, 2003**

(51) **LOC (7) Cl.** ..... **26-03**

(52) **U.S. Cl.** ..... **D26/94**

(58) **Field of Search** ..... D26/93-112, 51,  
D26/57; 362/410-414, 806; D1/101, 199;  
D7/509, 514, 518, 521-524, 305

(56) **References Cited**

**U.S. PATENT DOCUMENTS**

D382,667 S \* 8/1997 Buhriend et al. .... D26/94

**OTHER PUBLICATIONS**

Mixed drinks from:<URL: <http://artm-friends.at/rm/foto/classicdrinks.jpeg>, © 1979-2004, retrieved from the Internet on Aug. 23, 2004.\*

\* cited by examiner

*Primary Examiner*—Alan P. Douglas

*Assistant Examiner*—Linda Brooks

(74) *Attorney, Agent, or Firm*—Birch, Stewart, Kolasch & Birch, LLP

(57) **CLAIM**

The ornamental design for a cocktail lamp, as shown and described.

**DESCRIPTION**

FIG. 1 is a front, top perspective view of an cocktail lamp showing my new design;

FIG. 2 is a left side elevational view thereof;

FIG. 3 is a right side elevational view thereof;

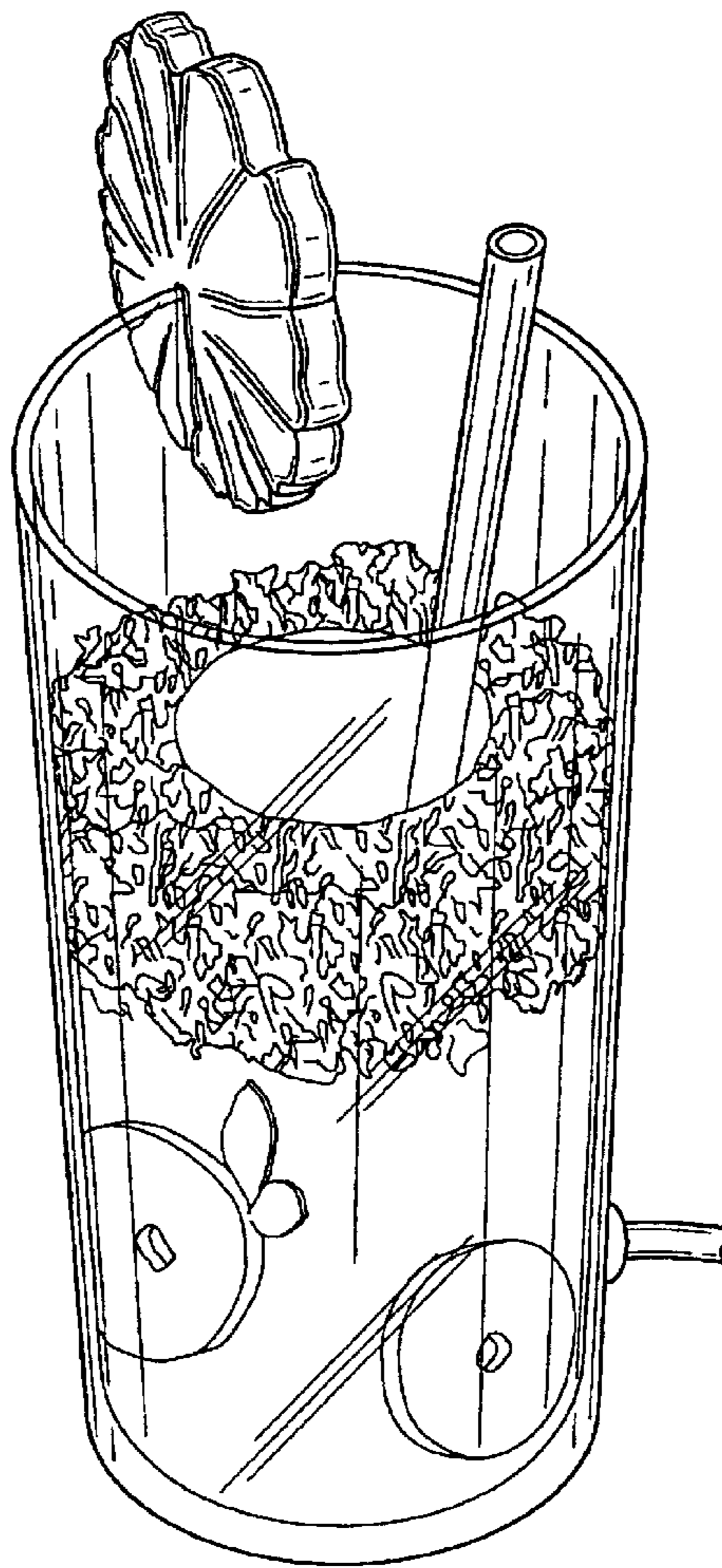
FIG. 4 is a rear side elevational view thereof;

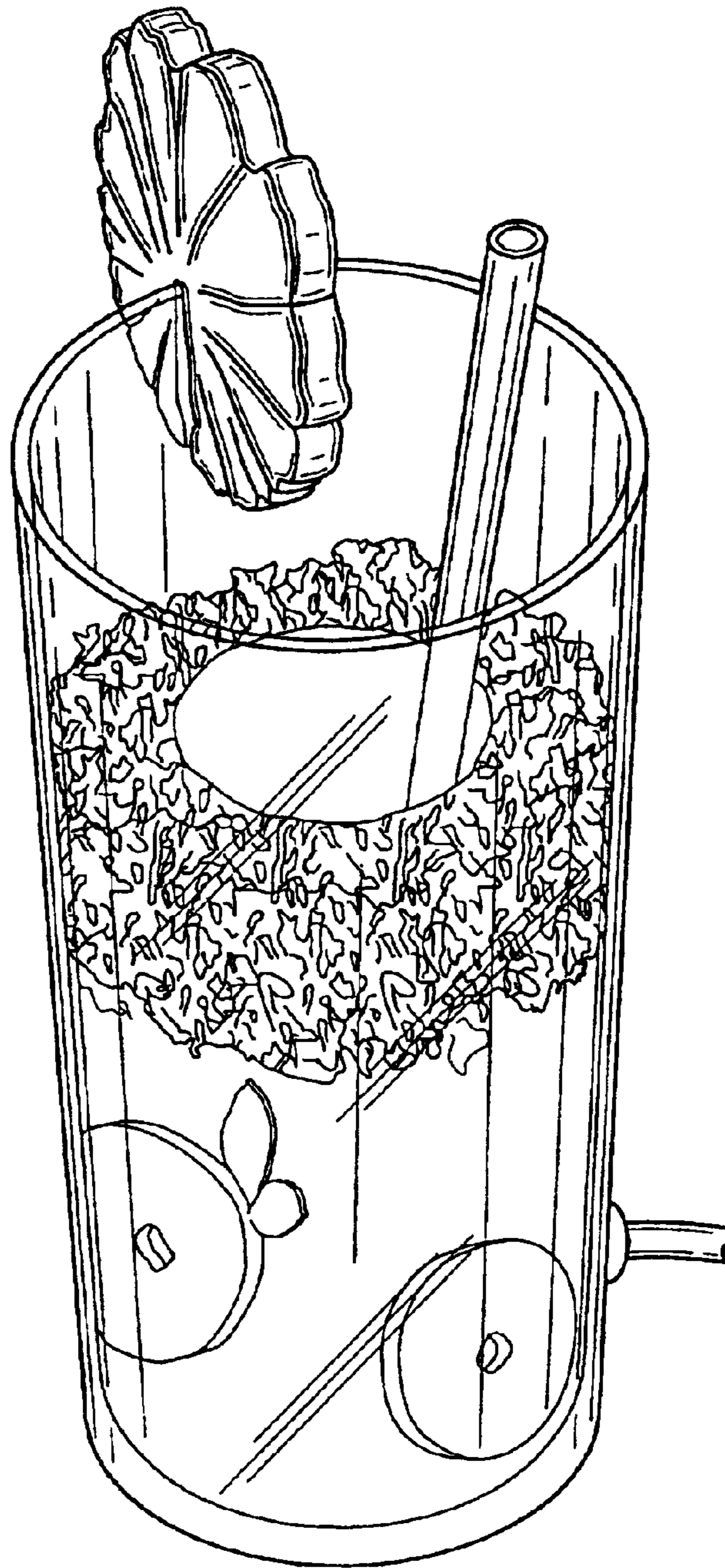
FIG. 5 is a front side elevational side view thereof;

FIG. 6 is a top plan thereof; and,

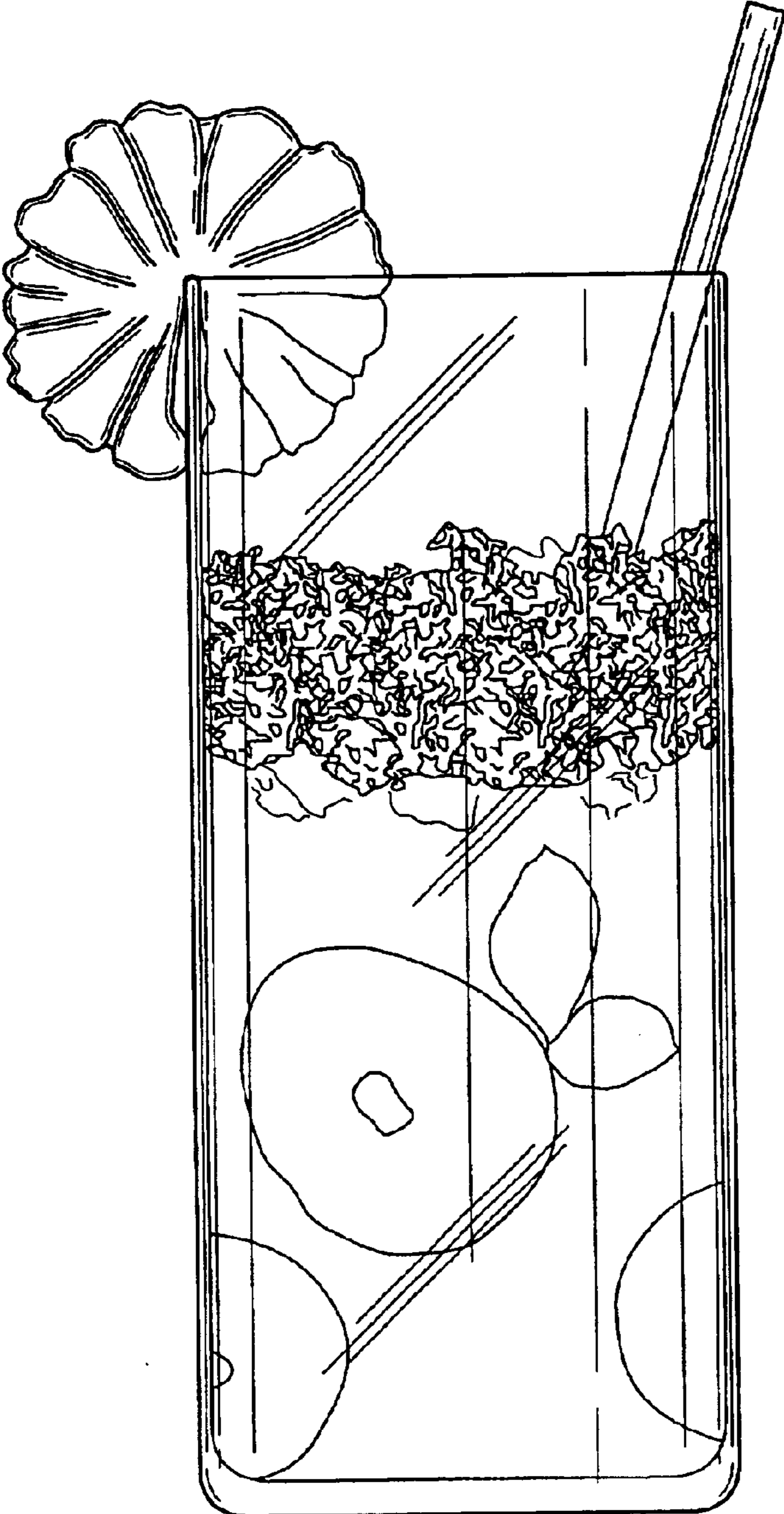
FIG. 7 is bottom view thereof.

**1 Claim, 6 Drawing Sheets**

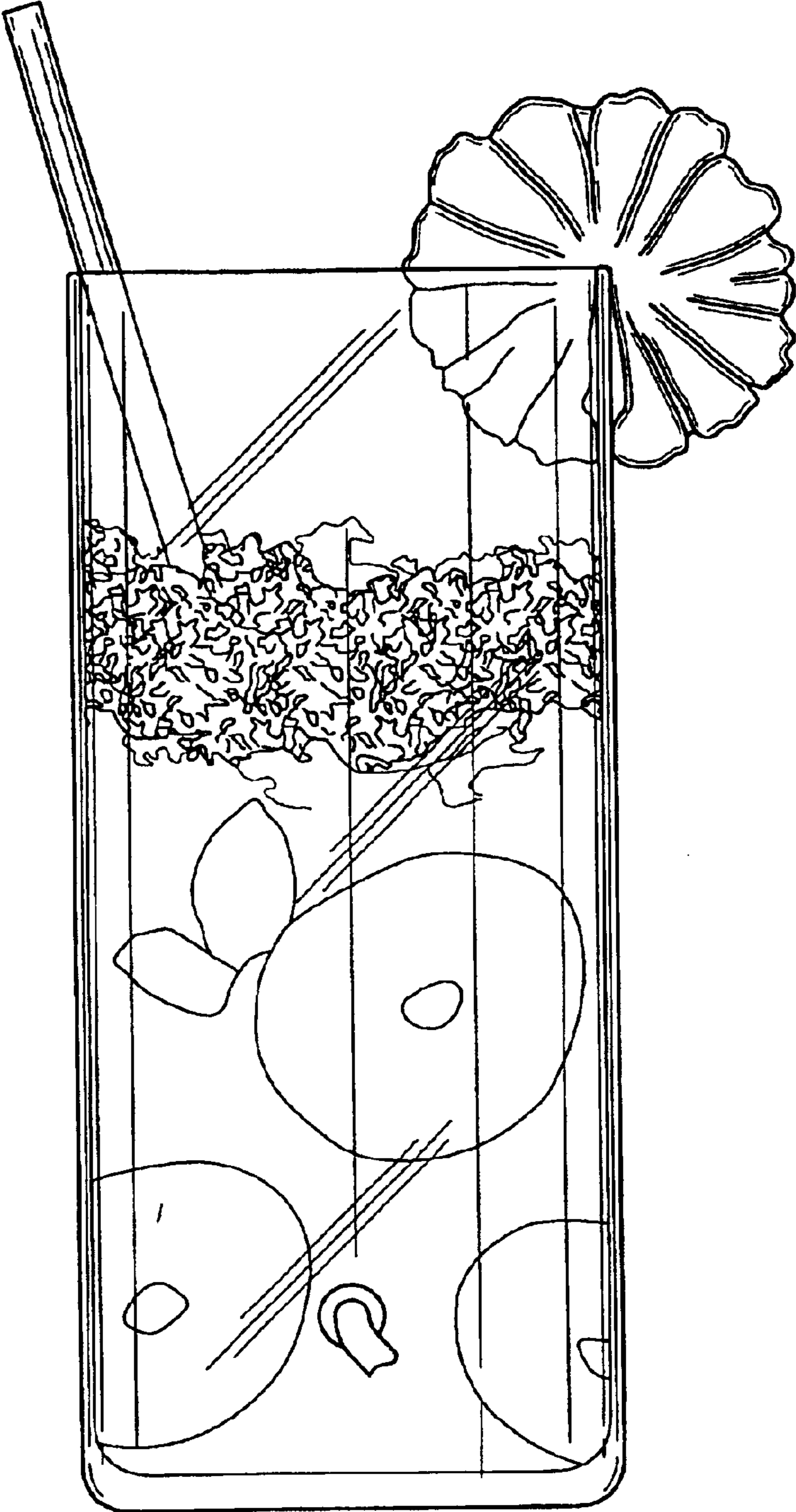




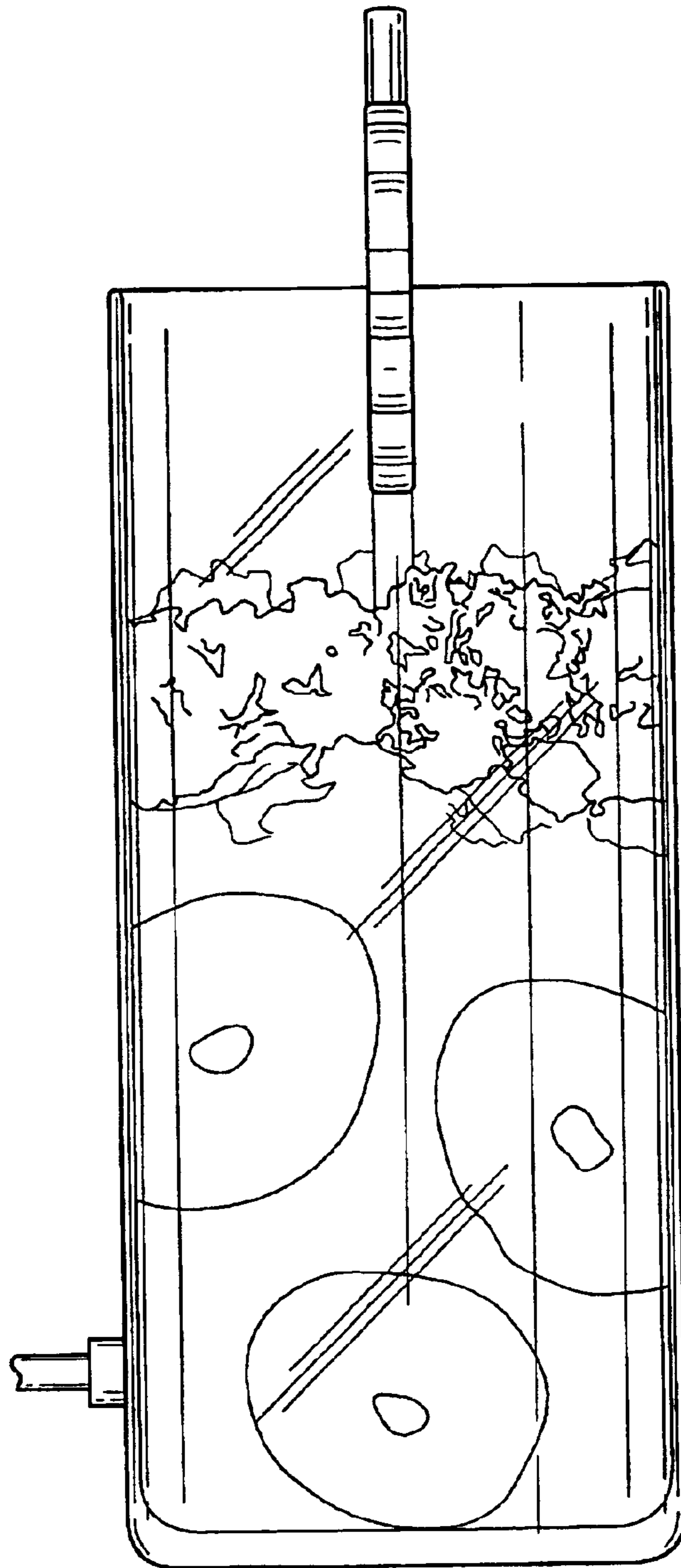
**FIG. 1**



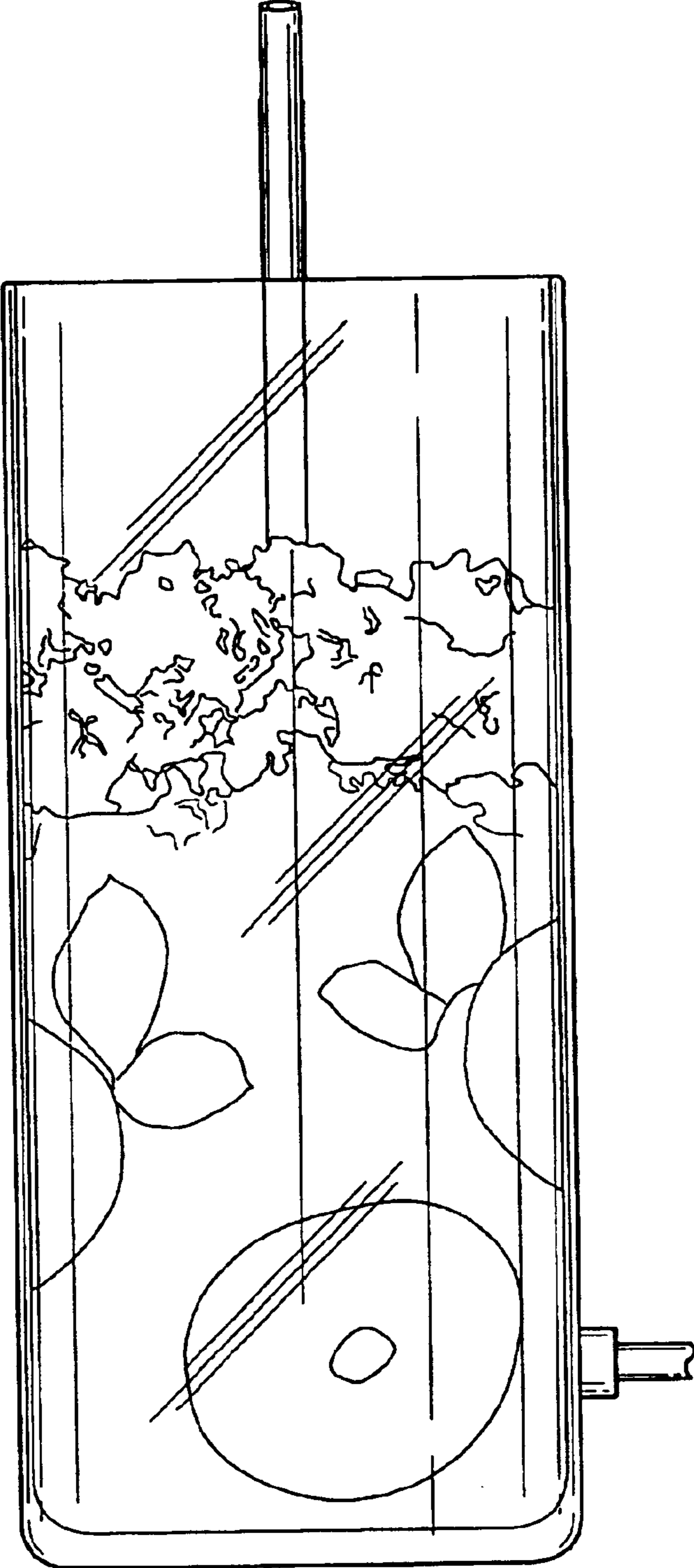
**FIG. 2**



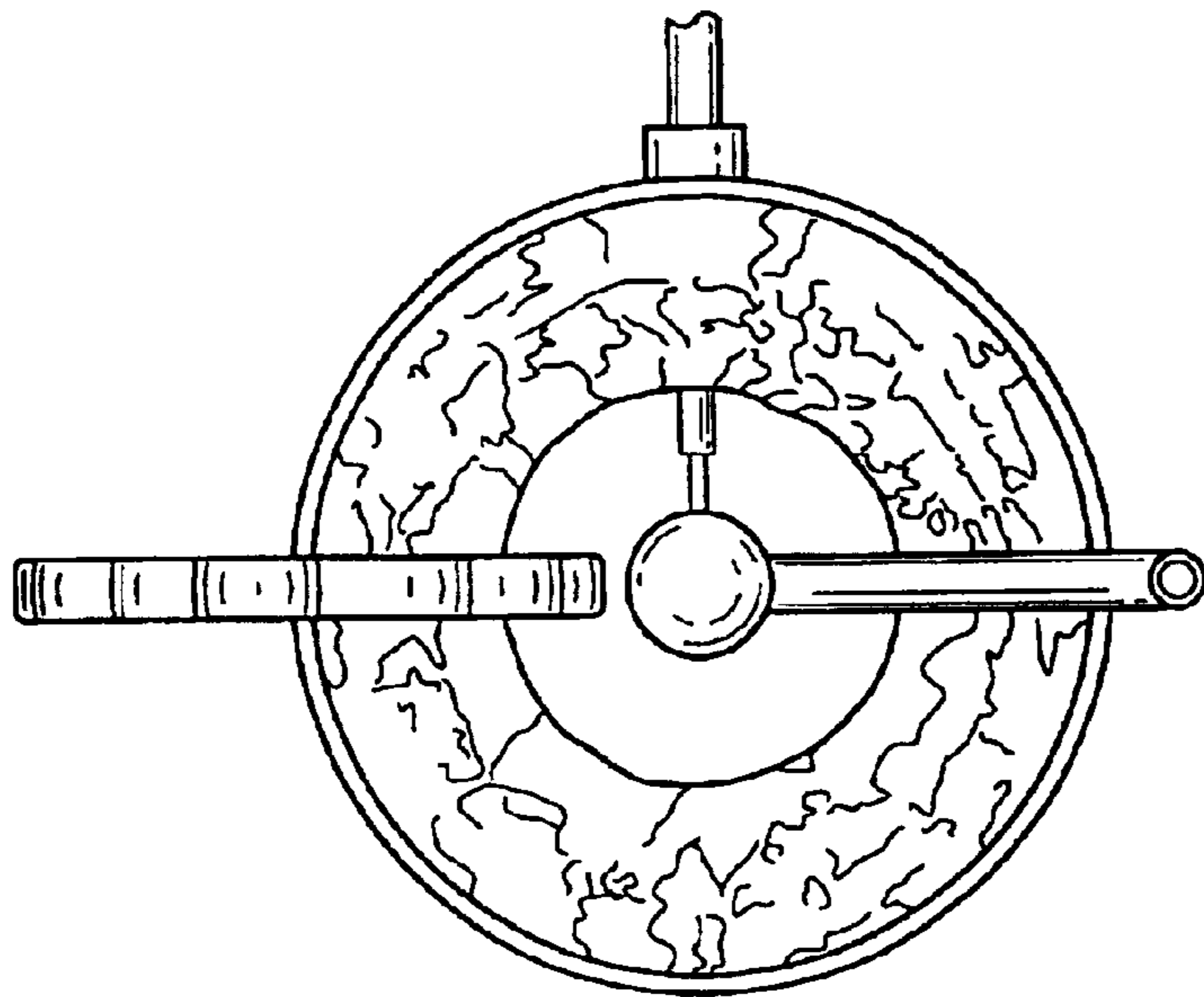
**FIG. 3**



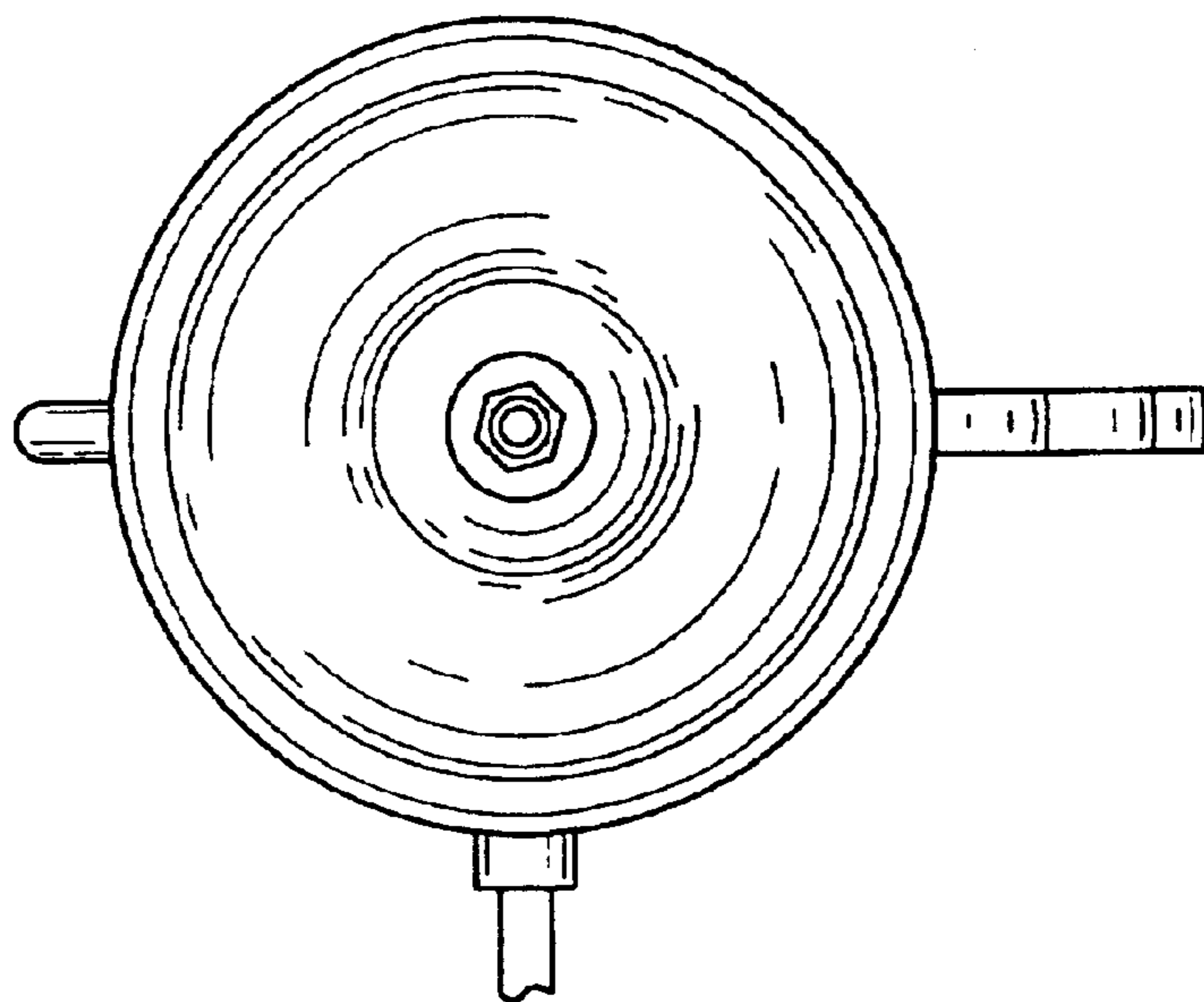
**FIG. 4**



**FIG. 5**



**FIG. 6**



**FIG. 7**