



US00D502394S

(12) **United States Design Patent** (10) **Patent No.:** **US D502,394 S**
Jackson et al. (45) **Date of Patent:** **** Mar. 1, 2005**

(54) **FOOD PACKAGE**

(75) Inventors: **Daniel C. Jackson**, Plymouth, MN (US); **Nicolas Bouveret**, St-Placide (CA); **Jean-Pierre Lacroix**, Bois d'Amont (FR)

(73) Assignee: **Land O'Lakes, Inc.**, Arden Hills, MN (US)

(**) Term: **14 Years**

(21) Appl. No.: **29/208,126**

(22) Filed: **Jun. 24, 2004**

Related U.S. Application Data

(62) Division of application No. 29/193,960, filed on Nov. 17, 2003, now Pat. No. Des. 496,272, which is a division of application No. 29/165,907, filed on Aug. 20, 2002, now Pat. No. Des. 489,975.

(51) **LOC (7) Cl.** **09-07**

(52) **U.S. Cl.** **D9/425; D9/428; D9/429; D7/602**

(58) **Field of Search** D9/424, 425, 428, D9/429, 430, 414; D3/304, 314; D7/587, 641, 602, 629; 206/503, 505, 557, 508, 566, 567; 220/656-659, 669-675, 556; 229/406, 407, 400, 938, 902-906; 426/106

(56) **References Cited**

U.S. PATENT DOCUMENTS

2,767,878	A	*	10/1956	Brown	220/228
D257,107	S		9/1980	Daenen et al.	D7/1
D276,400	S		11/1984	Daenen et al.	D7/79
D276,401	S		11/1984	Daenen et al.	D7/79
D276,402	S		11/1984	Daenen et al.	D7/79

(List continued on next page.)

OTHER PUBLICATIONS

Color Photographs of Packaging No. 1; views 1-1 through 1-8; four pages; publicly available prior to Aug. 20, 2001.

(List continued on next page.)

Primary Examiner—Prabhakar Deshmukh
(74) *Attorney, Agent, or Firm*—Westman, Champlin & Kelly, P.A.

(57) **CLAIM**

The ornamental design for a food package, as shown and described.

DESCRIPTION

FIG. 1 is a perspective view of a first embodiment of the food package of the present invention; FIG. 2 is a top plan view of the first embodiment; FIG. 3 is a front elevational view of the first embodiment; FIG. 4 is a right side elevational view of the first embodiment; FIG. 5 is a left side elevational view of the first embodiment; FIG. 6 is a rear elevational view of the first embodiment; FIG. 7 is a bottom plan view of the first embodiment; FIG. 8 is a perspective view of a second embodiment of the food package of the present invention; FIG. 9 is a top plan view of the second embodiment; FIG. 10 is a front elevational view of the second embodiment; FIG. 11 is a right side elevational view of the second embodiment; FIG. 12 is a left side elevational view of the second embodiment; FIG. 13 is a rear elevational view of the second embodiment; FIG. 14 is a bottom plan view of the second embodiment; FIG. 15 is a perspective view of a third embodiment of the food package of the present invention; FIG. 16 is a top plan view of the third embodiment; FIG. 17 is a front elevational view of the third embodiment; FIG. 18 is a right side elevational view of the third embodiment; FIG. 19 is a left side elevational view of the third embodiment; FIG. 20 is a rear elevational view of the third embodiment; and, FIG. 21 is a bottom plan view of the third embodiment.

1 Claim, 6 Drawing Sheets

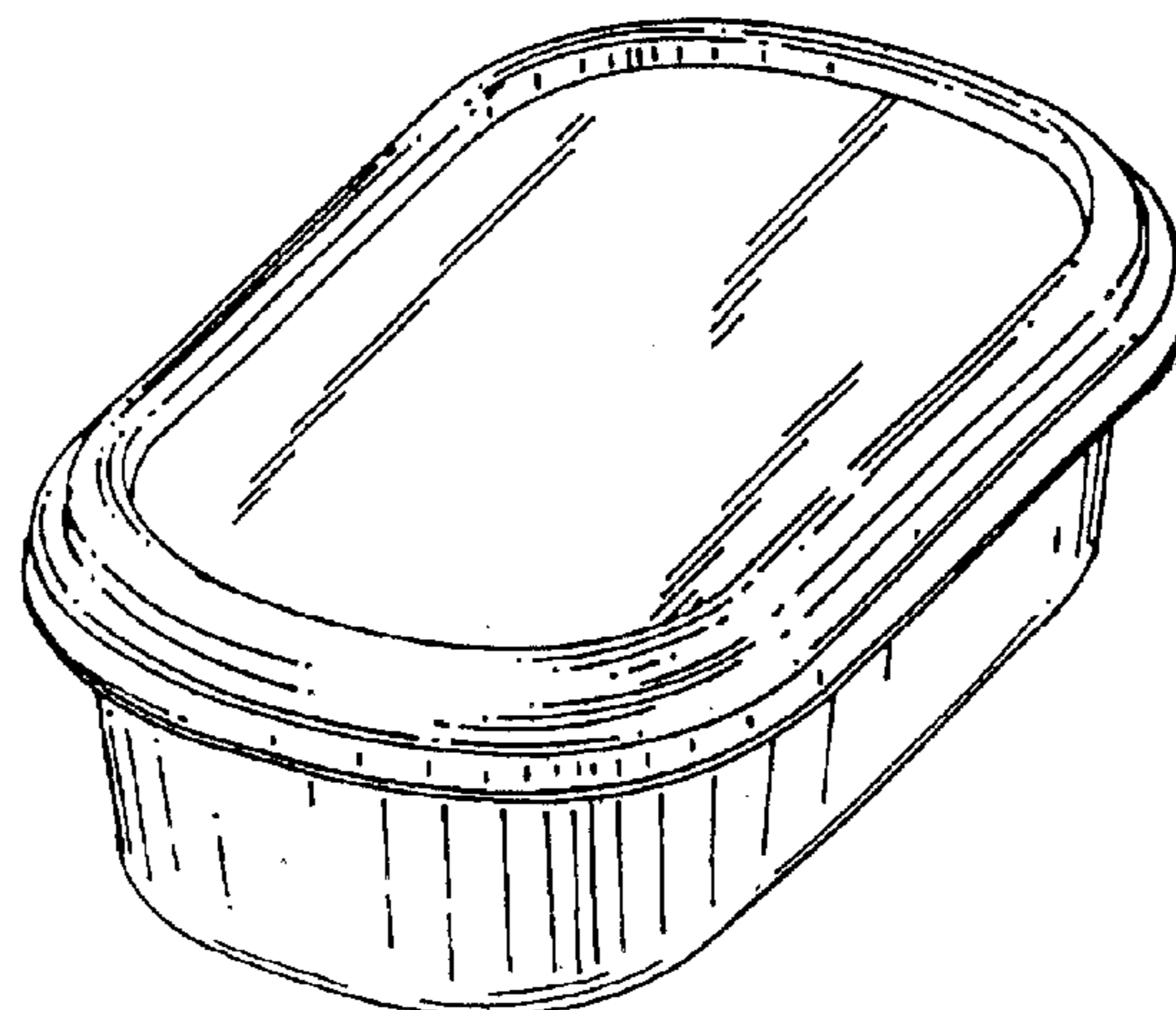

U.S. PATENT DOCUMENTS

D285,906 S	*	9/1986	Tyler	D9/425
D305,410 S	*	1/1990	Tyler	D9/425
D312,968 S		12/1990	Wolff	D9/431
5,029,725 A	*	7/1991	Roth	220/655
D330,312 S		10/1992	Narsutis	D7/629
5,503,886 A	*	4/1996	Guarriello et al.	428/35.7
D371,962 S		7/1996	Peruzzi	D9/423
D392,884 S		3/1998	Hayes	D9/431
D418,055 S	*	12/1999	Veto	D9/425
D428,310 S		7/2000	Zettle et al.	D7/629
6,170,696 B1		1/2001	Tucker et al.	220/793
D437,685 S		2/2001	Liu	D3/294
D440,470 S		4/2001	Tucker et al.	D7/629
D440,830 S		4/2001	Tucker et al.	D7/629
D442,484 S		5/2001	Maxwell et al.	D9/347
D443,184 S		6/2001	Maxwell et al.	D7/629
D443,798 S		6/2001	Tucker et al.	D7/629
D445,311 S		7/2001	Emonet et al.	D7/629
D445,649 S		7/2001	Maxwell et al.	D7/629
D445,650 S		7/2001	Maxwell et al.	D7/629
D446,077 S		8/2001	Tucker et al.	D7/392.1
D447,382 S		9/2001	Tucker et al.	D7/392.1
D449,495 S		10/2001	Tucker et al.	D7/629
D450,983 S		11/2001	Tucker et al.	D7/629
D451,769 S		12/2001	Stanos et al.	D7/629
D456,713 S		5/2002	Bried et al.	D9/449
D462,880 S		9/2002	Maxwell et al.	D7/629
6,467,647 B1		10/2002	Tucker et al.	220/793
6,557,720 B2	*	5/2003	Tosdale et al.	220/657

OTHER PUBLICATIONS

Color Photographs of Packaging No. 2 views 2-1 through 2-8; four pages; publicly available prior to Aug. 20, 2001.
 Color Photographs of Packaging No. 3; views 3-1 through 3-9; five pages; publicly available prior to Aug. 20, 2001.
 Color Photographs of Packaging No. 4; views 4-1 through 4-5; three pages; publicly available prior to Aug. 20, 2001.
 Color Photographs of Packaging No. 5; views 5-1 through 5-5; three pages; publicly available prior to Aug. 20, 2001.
 Color Photographs of Packaging No. 6; views 6-1 through 6-9; five pages; publicly available prior to Aug. 20, 2001.
 Color Photographs of Packaging No. 7; views 7-1 through 7-9; five pages; publicly available prior to Aug. 20, 2001.
 Color Photographs of Packaging No. 8; views 8-1 through 8-9; five pages; publicly available prior to Aug. 20, 2001.
 Color Photographs of Packaging No. 9; views 9-1 through 9-9; five pages; publicly available prior to Aug. 20, 2001.
 Color Photographs of Packaging No. 10; views 10-1 through 10-5; three pages; publicly available prior to Aug. 20, 2001.
 Color Photographs of Packaging No. 11; views 11-1 through 11-5; three pages; publicly available prior to Aug. 20, 2001.
 Color Photographs of Packaging No. 12; views 12-1 through 12-9; five pages; publicly available prior to Aug. 20, 2001.

Color Photographs of Packaging No. 13; views 13-1 through 13-9; five pages; publicly available prior to Aug. 20, 2001.

Color Photographs of Packaging No. 14; views 14-1 through 14-5; three pages; publicly available prior to Aug. 20, 2001.

Color Photographs of Packaging No. 15; views 15-1 through 15-5; three pages; publicly available prior to Aug. 20, 2001.

Color Photographs of Packaging No. 16; views 16-1 through 16-9; five pages; publicly available prior to Aug. 20, 2001.

Color Photographs of Packaging No. 17; views 17-1 through 17-9; five pages; publicly available prior to Aug. 20, 2001.

Color Photographs of Packaging No. 18; views 18-1 through 18-5; three pages; publicly available prior to Aug. 20, 2001.

Color Photographs of Packaging No. 19; views 19-1 through 19-9; five pages; publicly available prior to Aug. 20, 2001.

Color Photographs of Packaging No. 20; views 20-1 through 20-5; three pages; publicly available prior to Aug. 20, 2001.

Color Photographs of Packaging No. 21; views 21-1 through 21-9; five pages; publicly available prior to Aug. 20, 2001.

Color Photographs of Packaging No. 22; views 22-1 through 22-9; five pages; publicly available prior to Aug. 20, 2001.

Color Photographs of Packaging No. 23; views 23-1 through 23-5; three pages; publicly available prior to Aug. 20, 2001.

Color Photographs of Packaging No. 24; views 24-1 through 24-9; five pages; publicly available prior to Aug. 20, 2001.

Color Photographs of Packaging No. 25; views 25-1; one page; publicly available prior to Aug. 20, 2001.

Color Photographs of Packaging No. 26; views 26-1 through 26-5; three pages; publicly available prior to Aug. 20, 2001.

Color Photographs of Packaging No. 27; views 27-1 through 27-9; five pages; publicly available prior to Aug. 20, 2001.

Color Photographs of Packaging No. 28; views 28-1 through 28-9; five pages; publicly available prior to Aug. 20, 2001.

Color Photographs of Packaging No. 29; views 29-1 through 29-5; three pages; publicly available prior to Aug. 20, 2001.

* cited by examiner

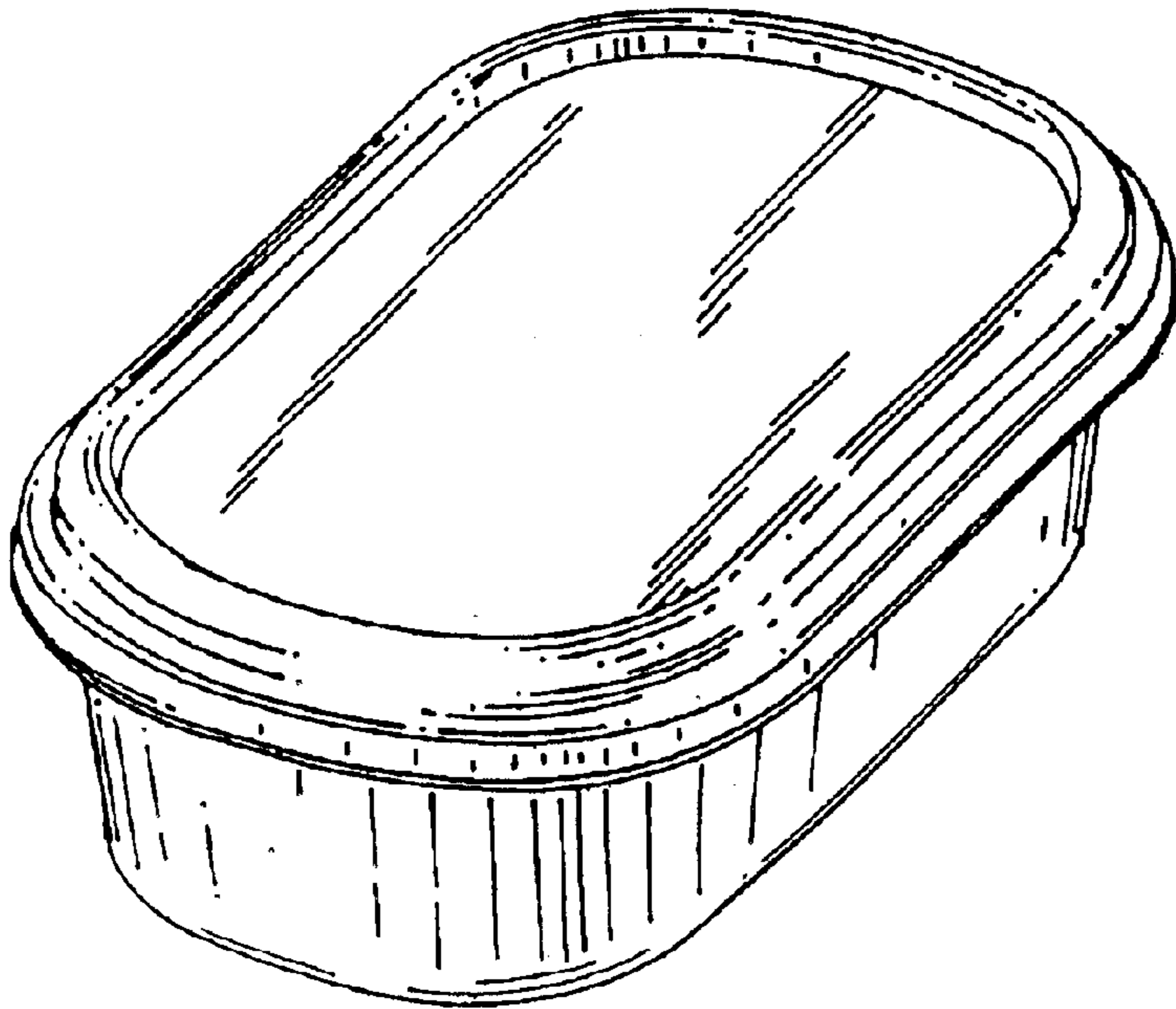

Fig. 1

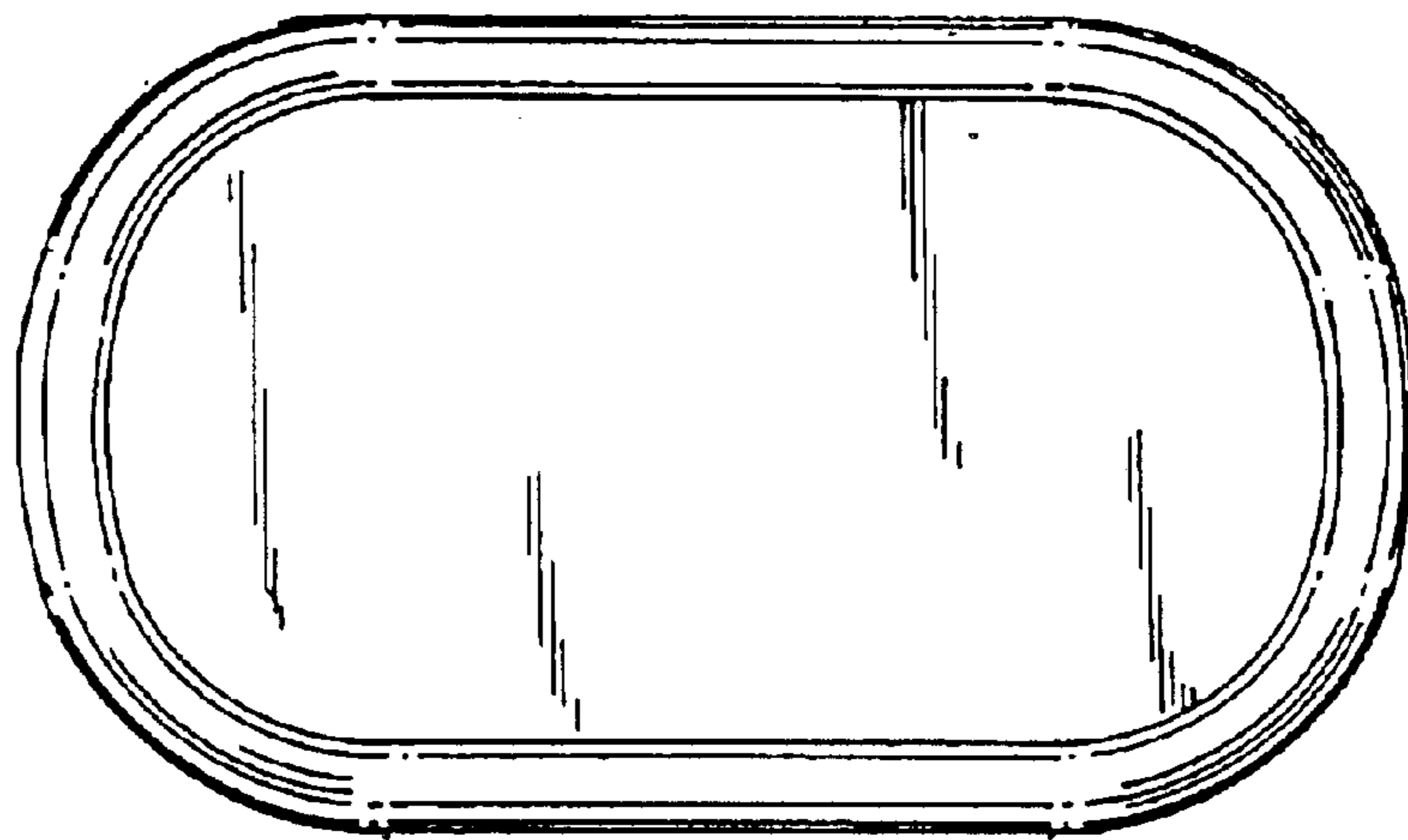

Fig. 2

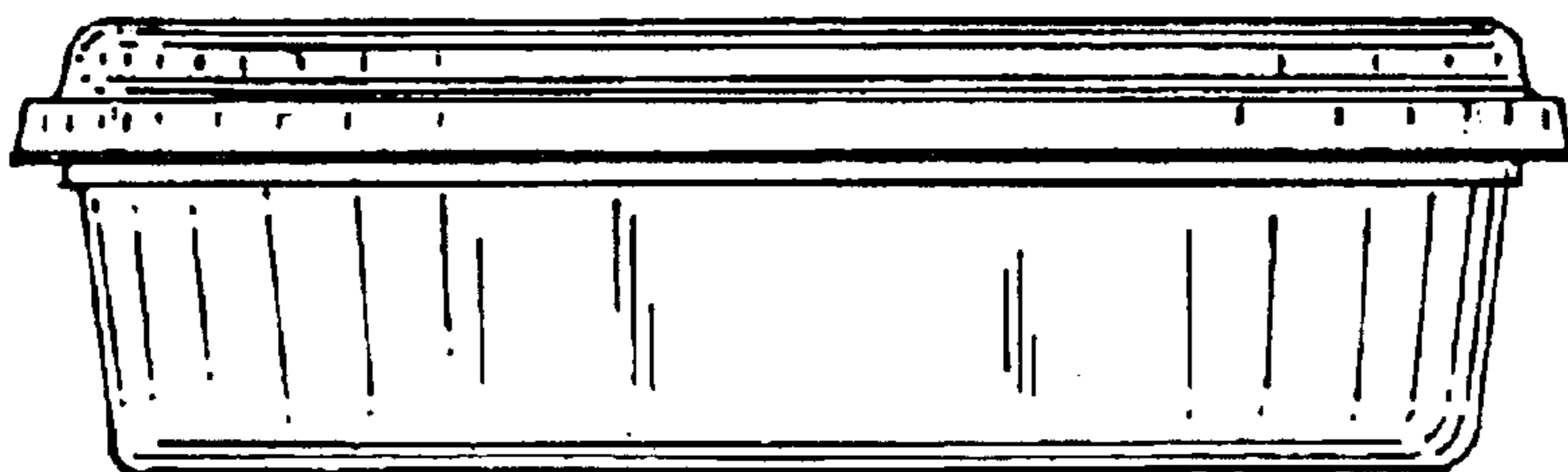

Fig. 3

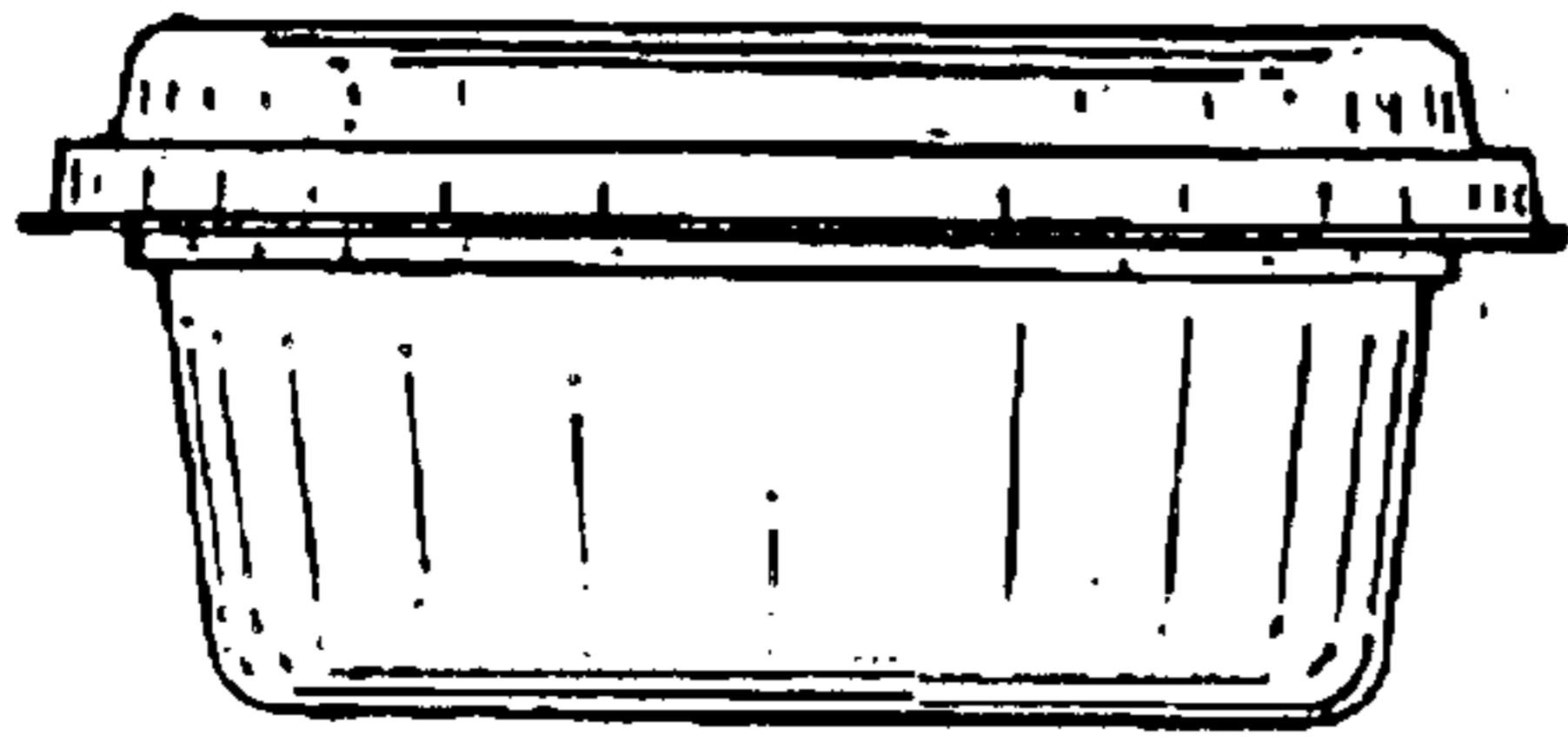

Fig. 4

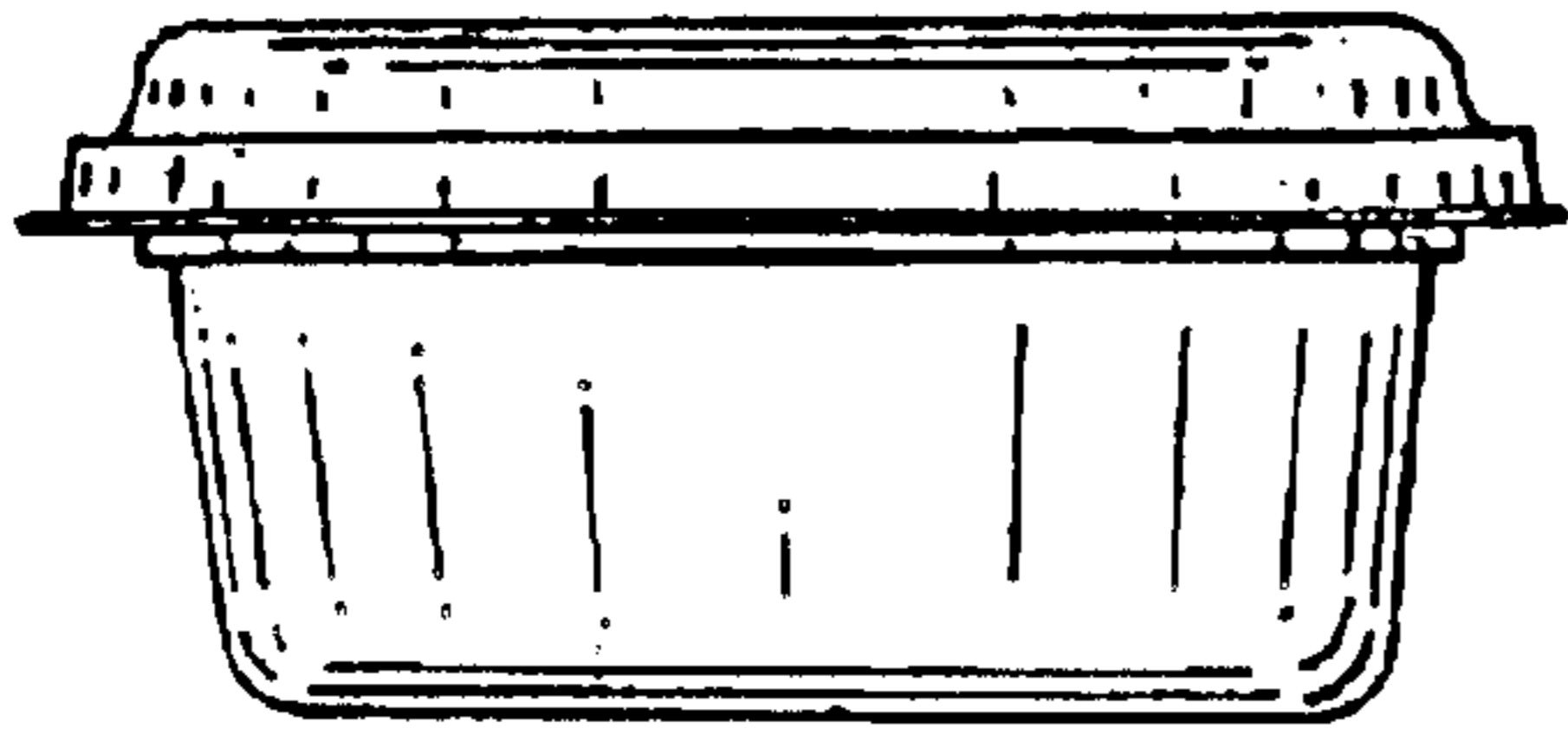

Fig. 5

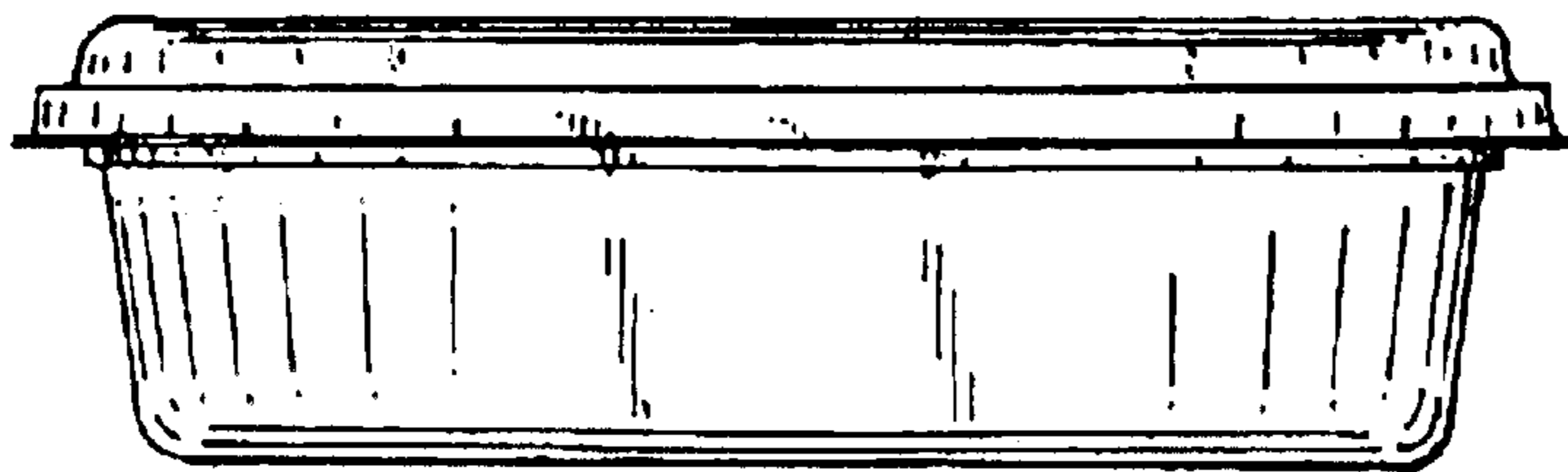

Fig. 6

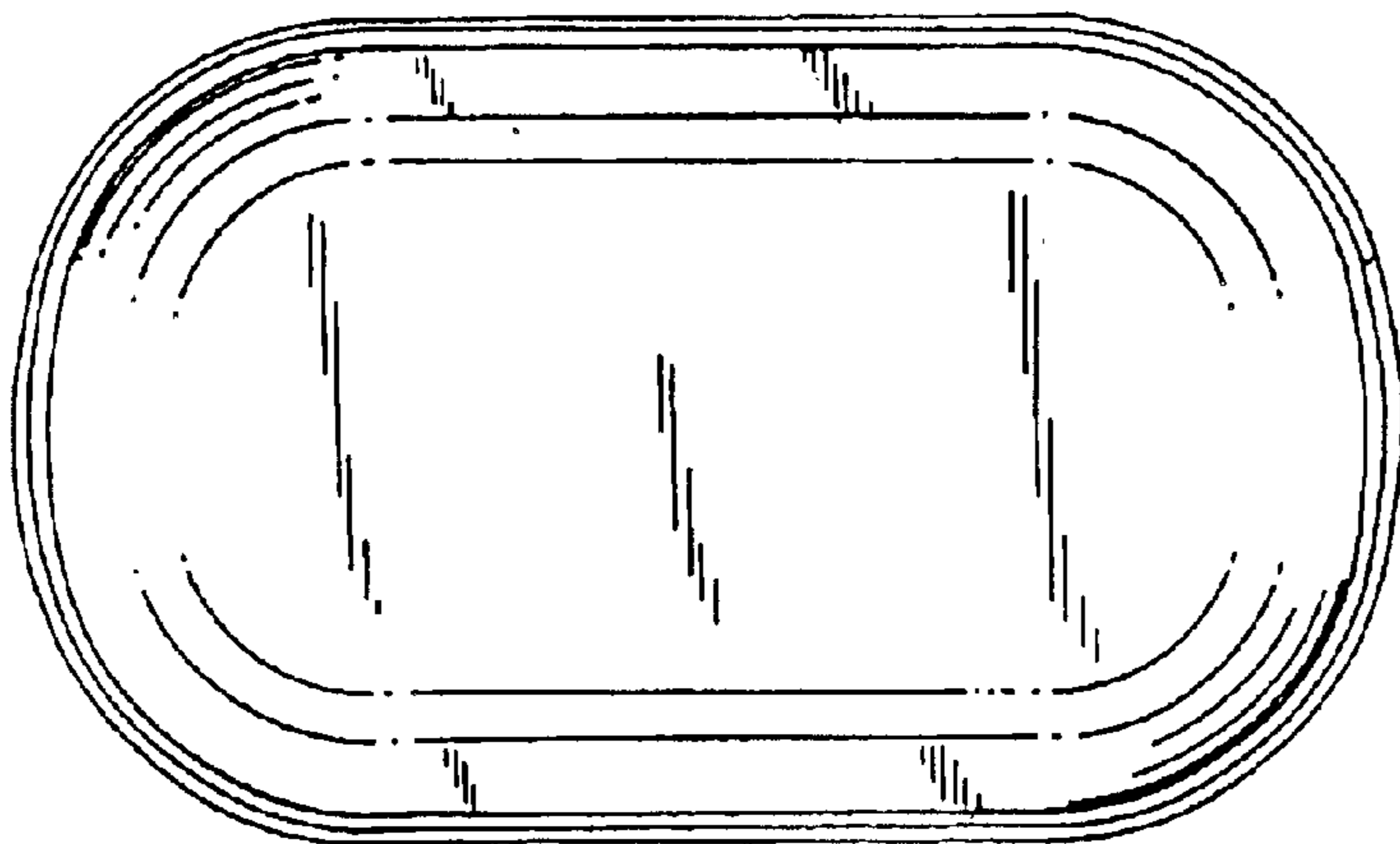

Fig. 7

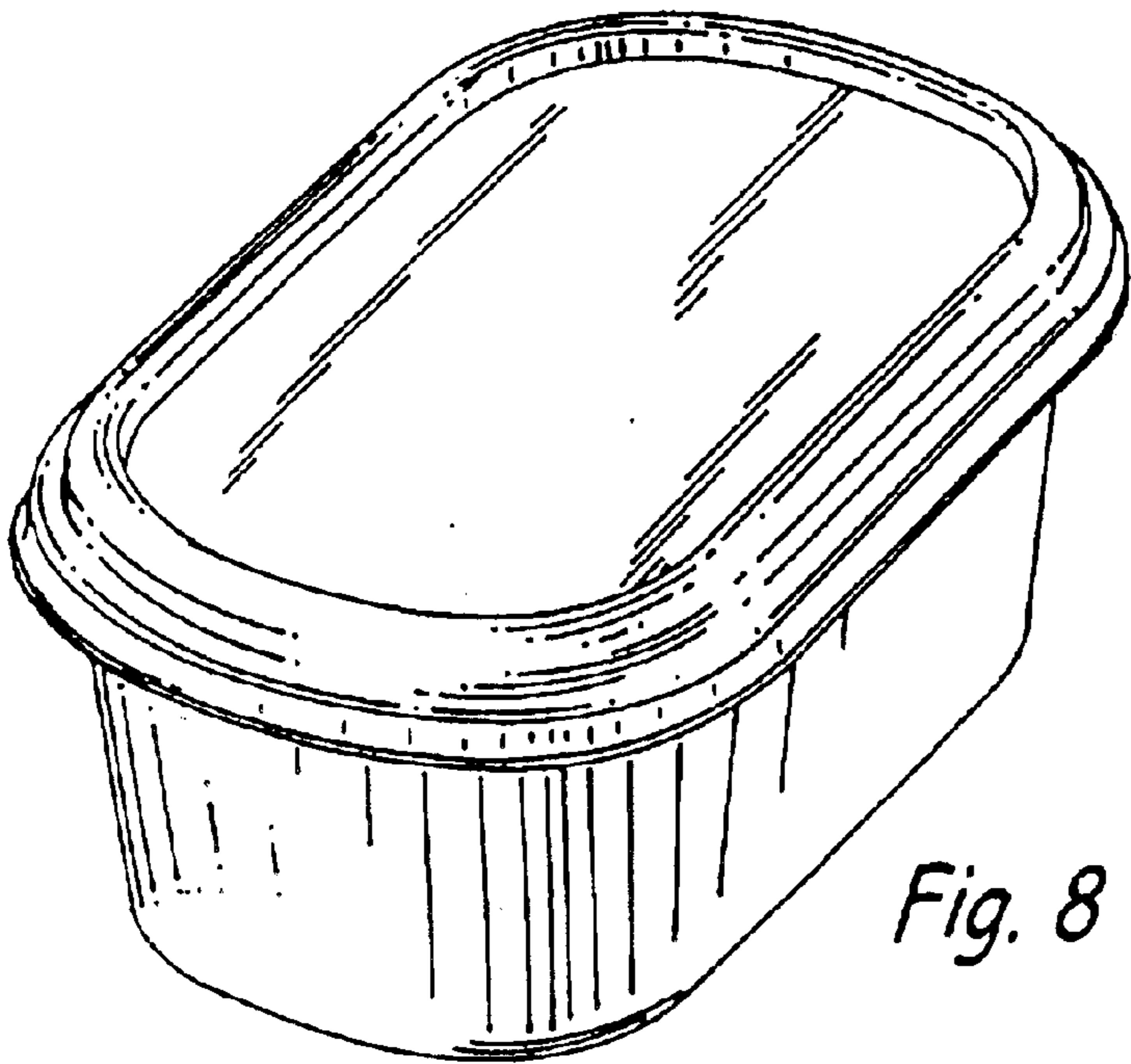

Fig. 8



Fig. 9

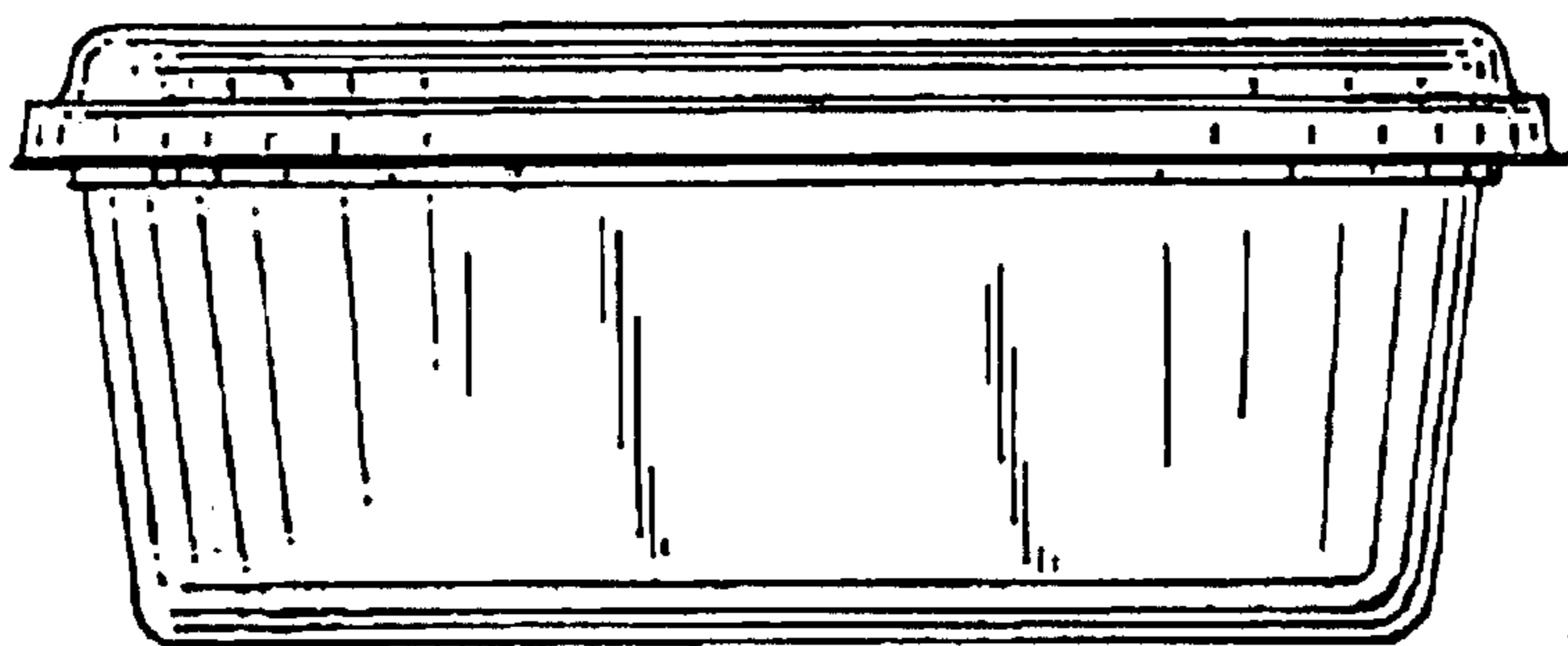

Fig. 10

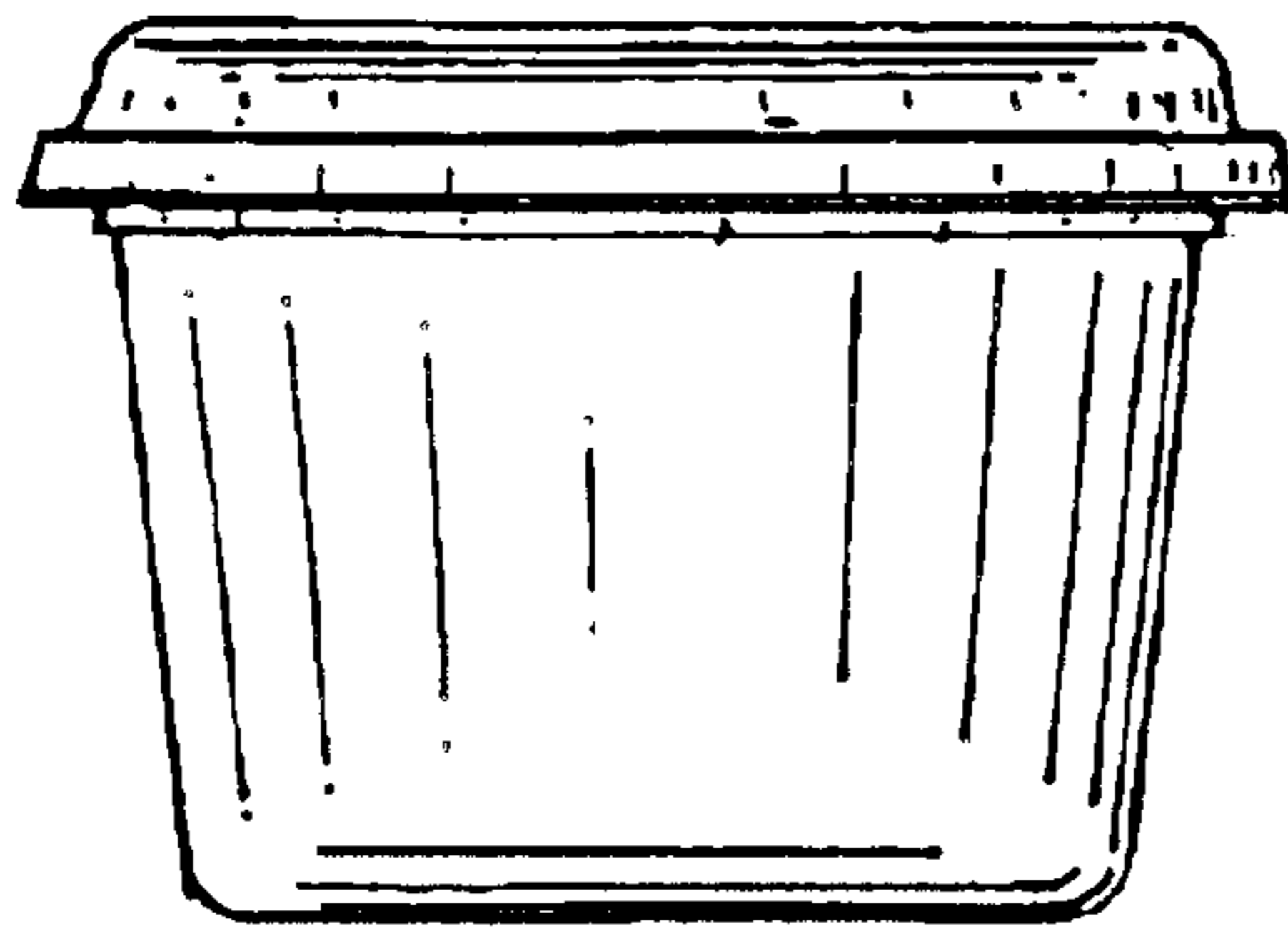

Fig. 11

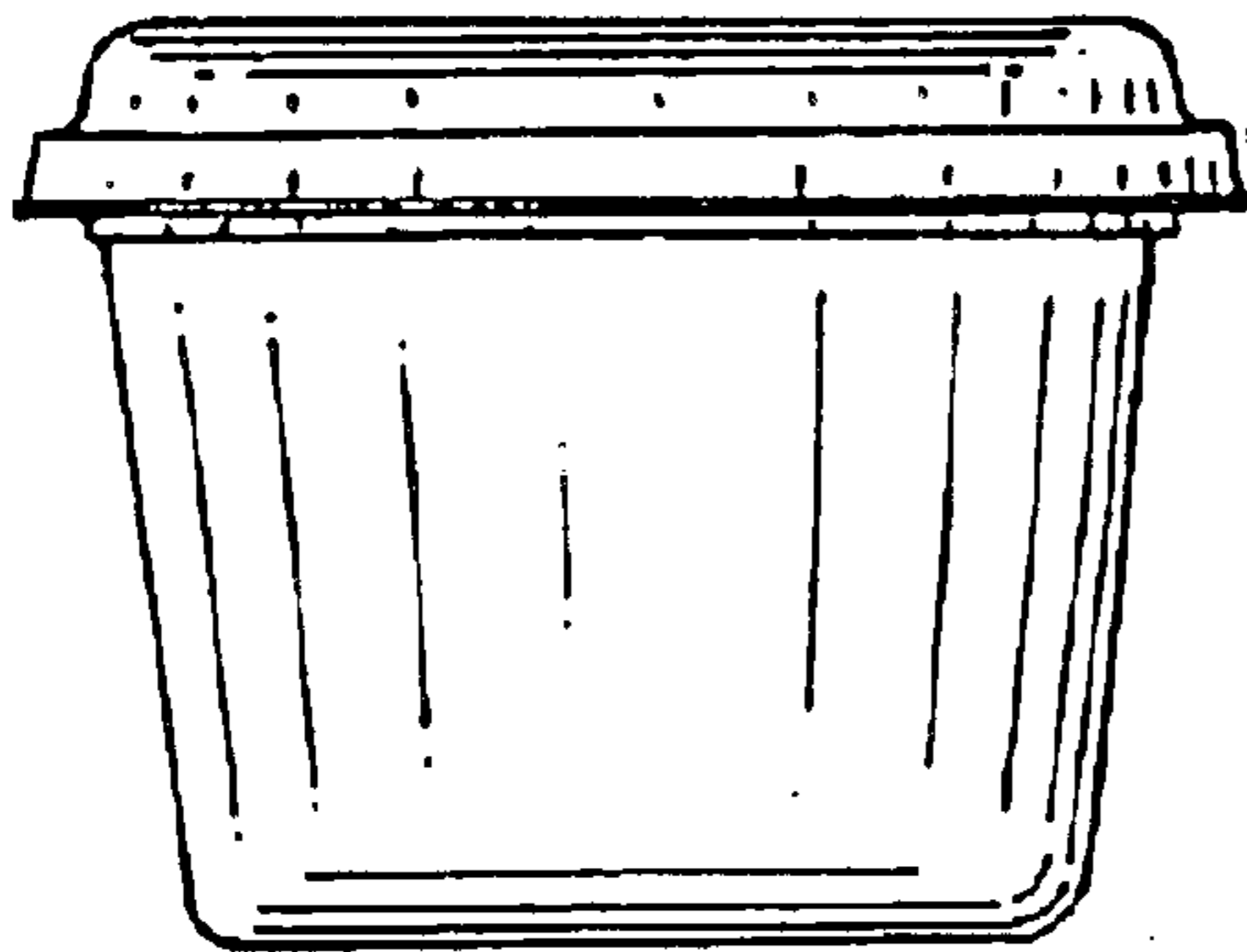

Fig. 12

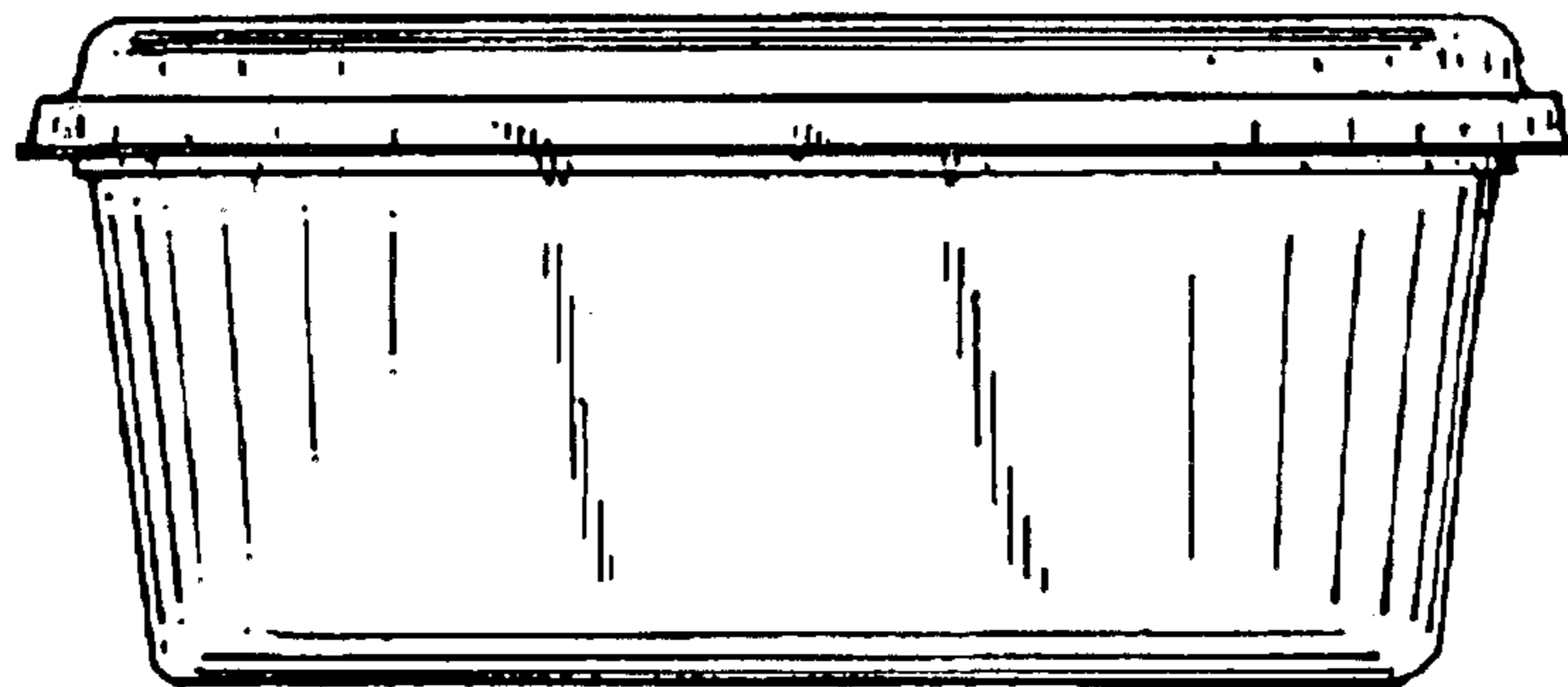

Fig. 13

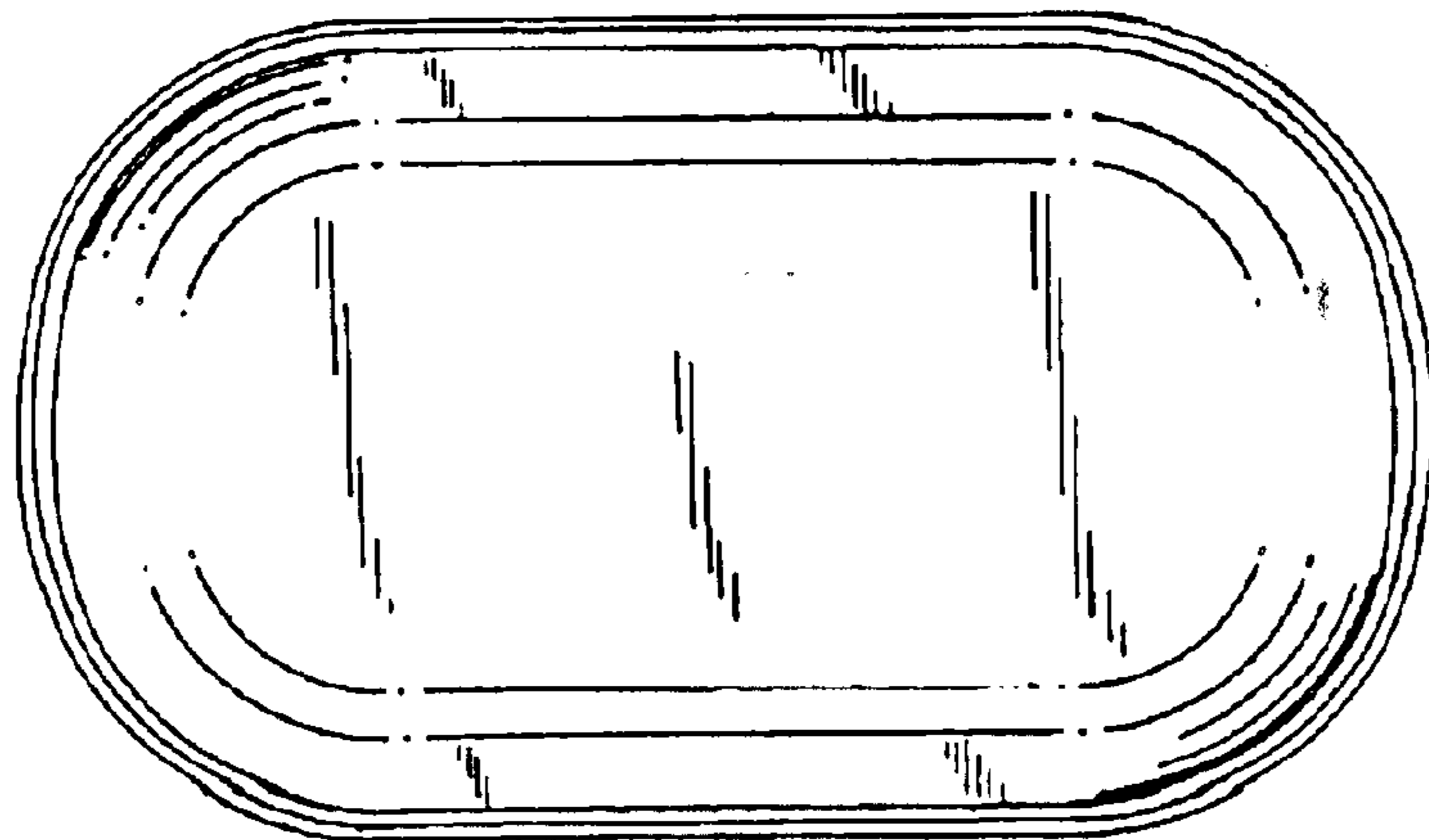

Fig. 14

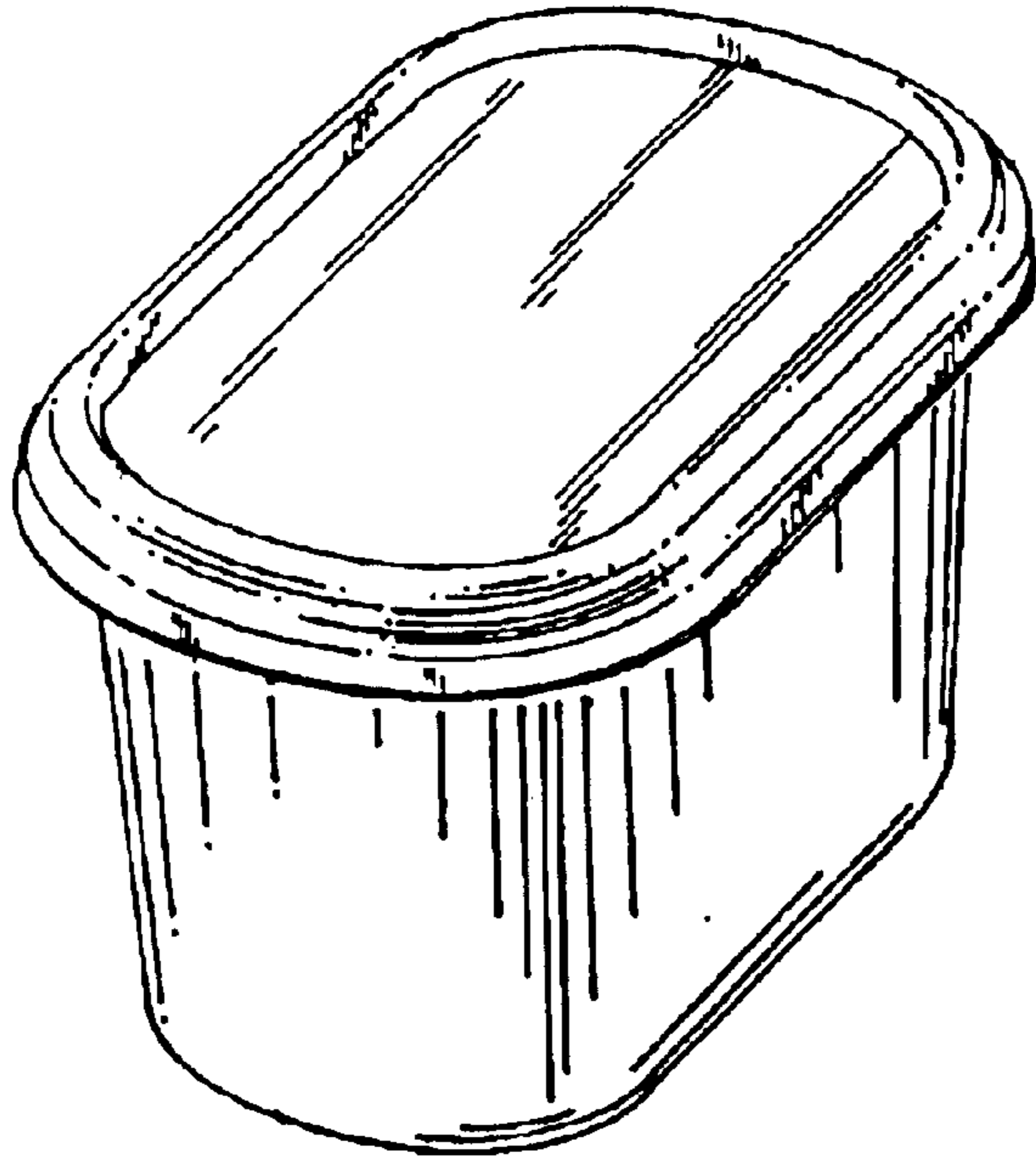

Fig. 15

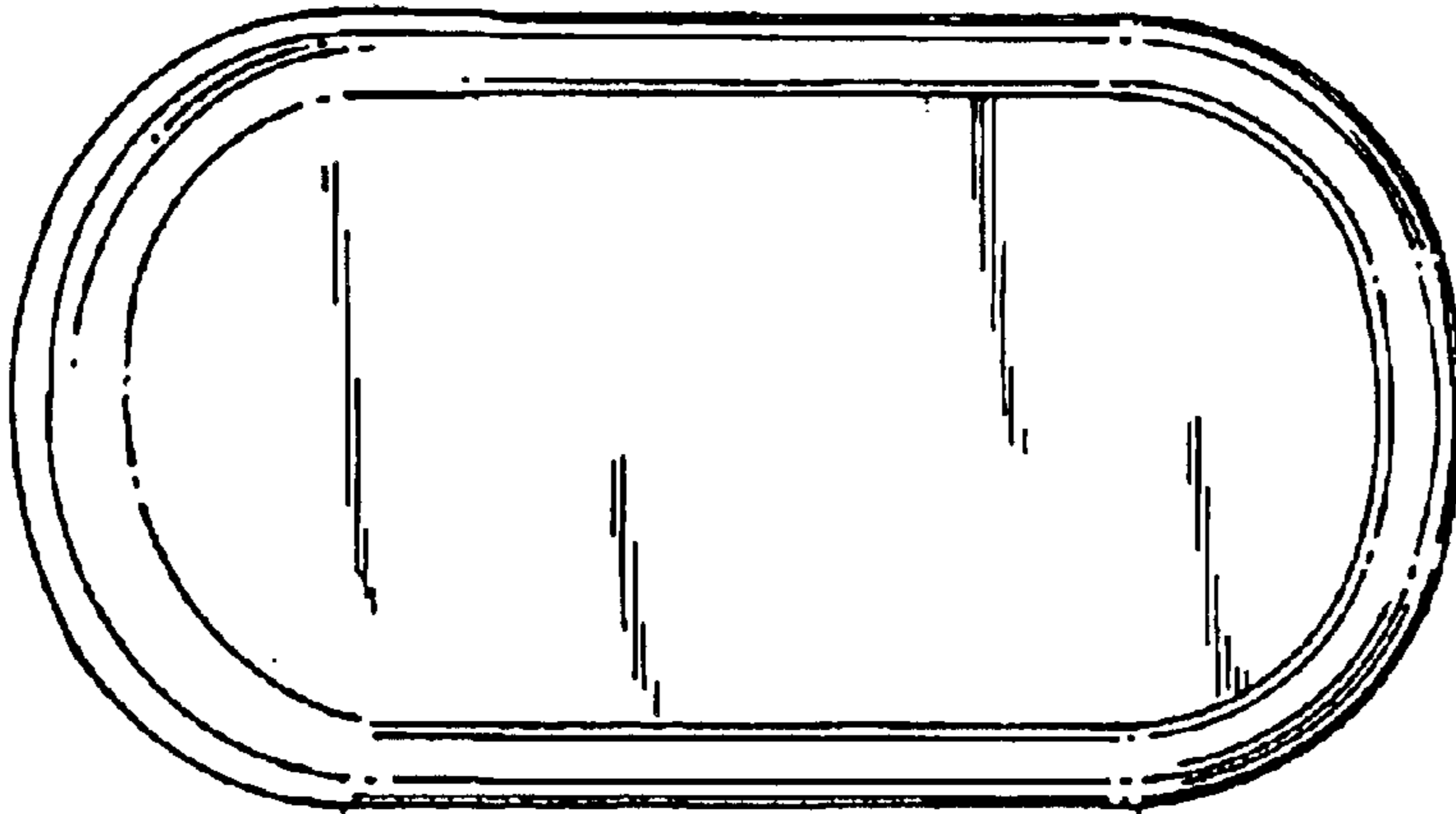

Fig. 16

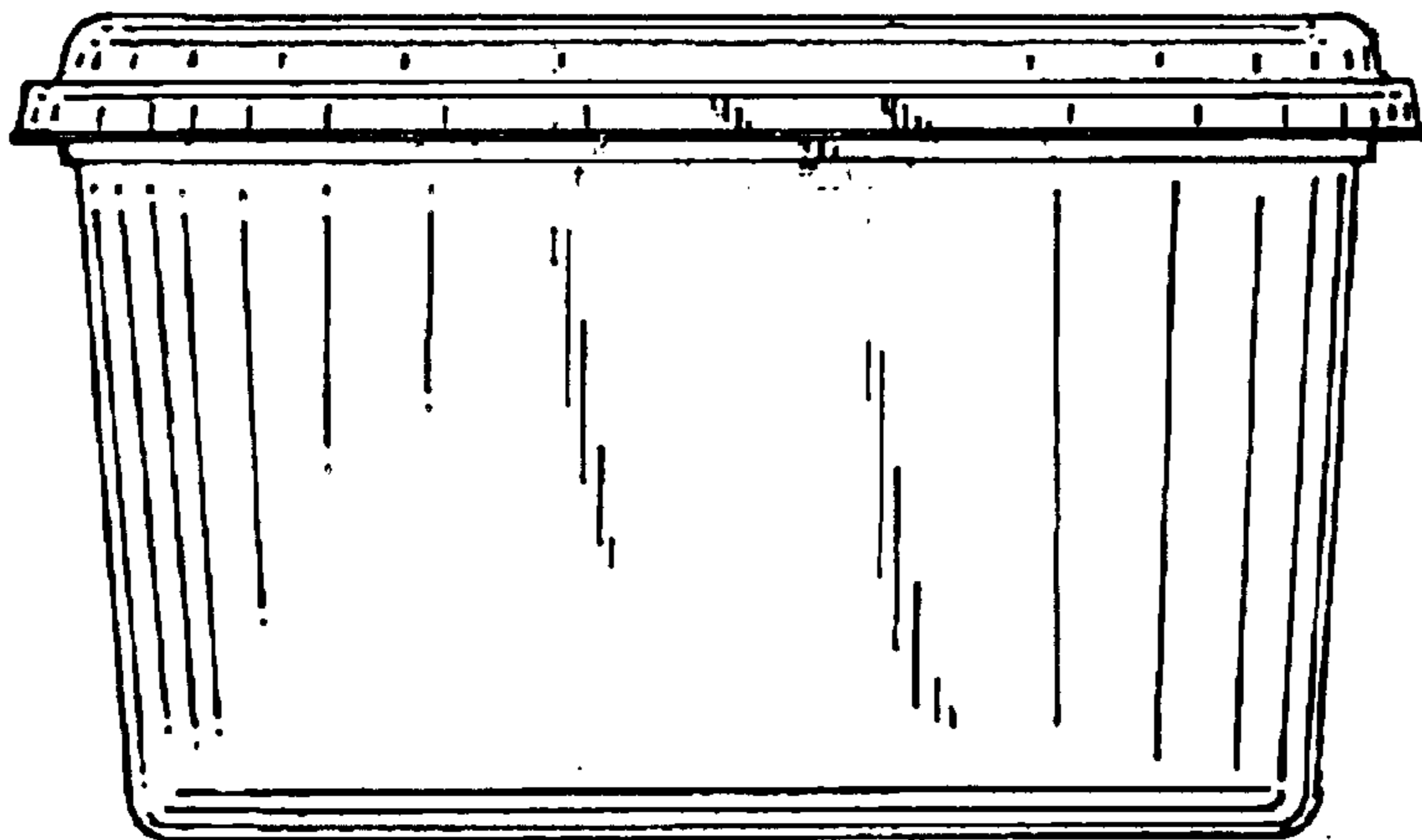

Fig. 17

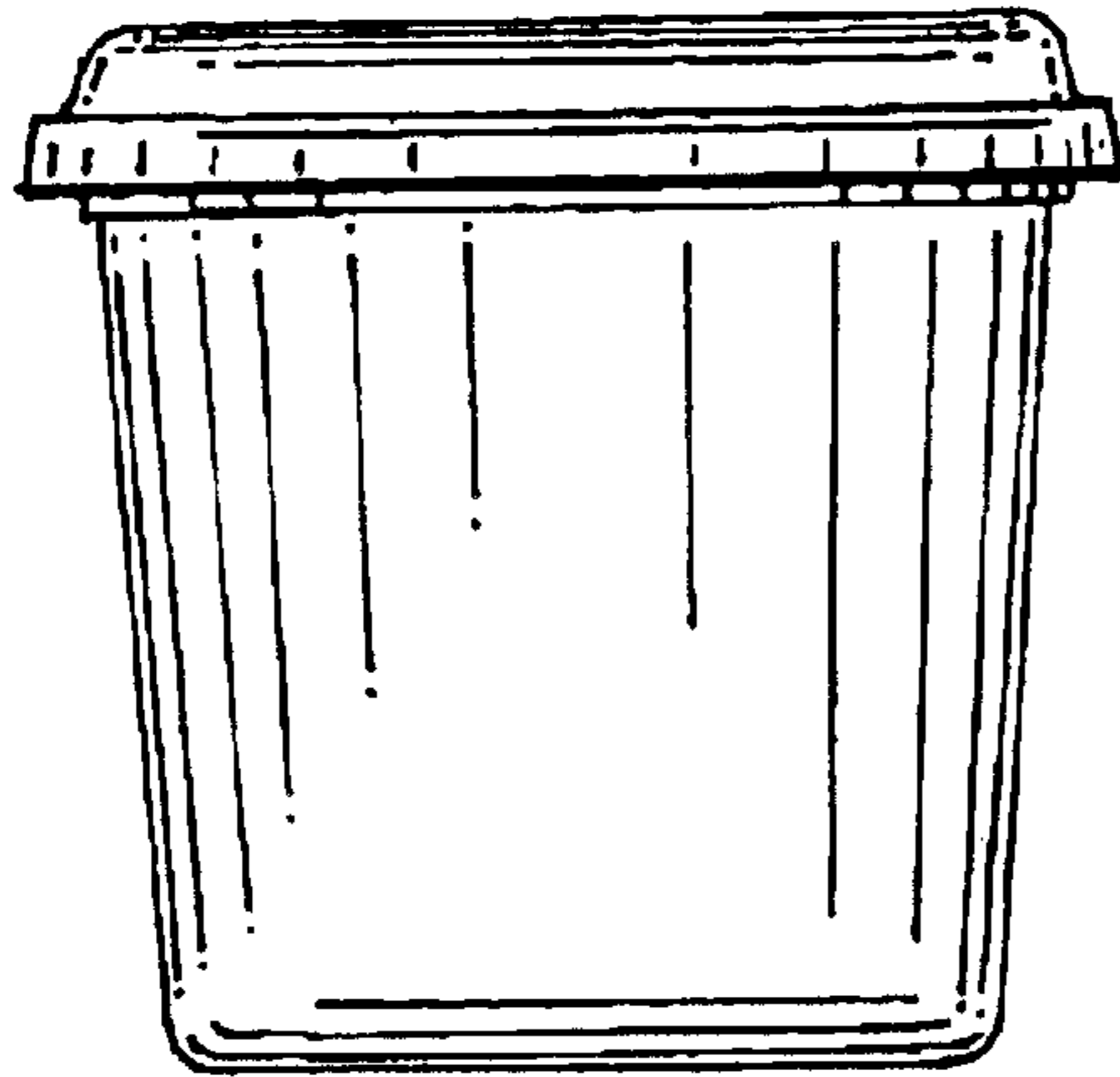

Fig. 18

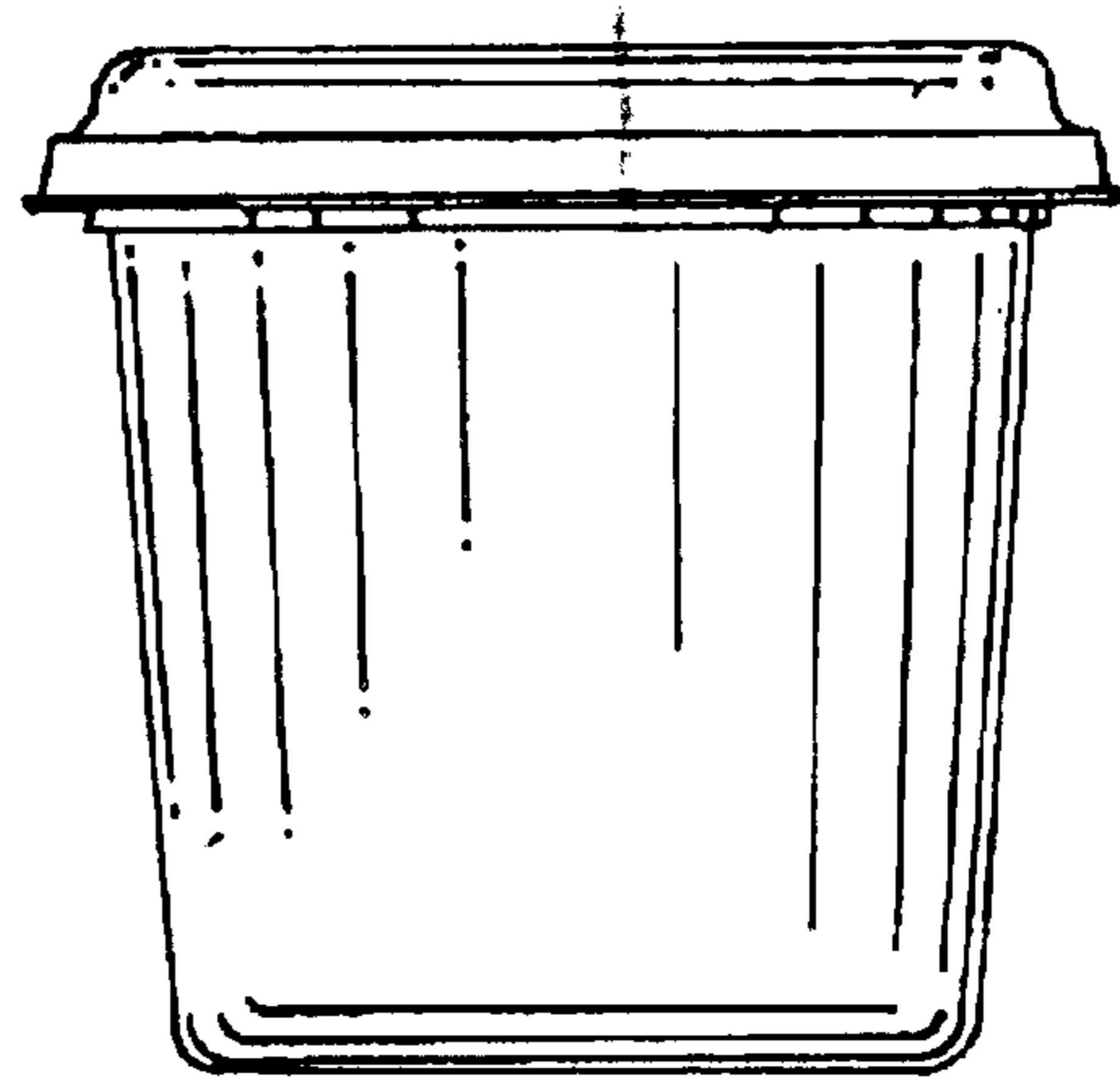

Fig. 19

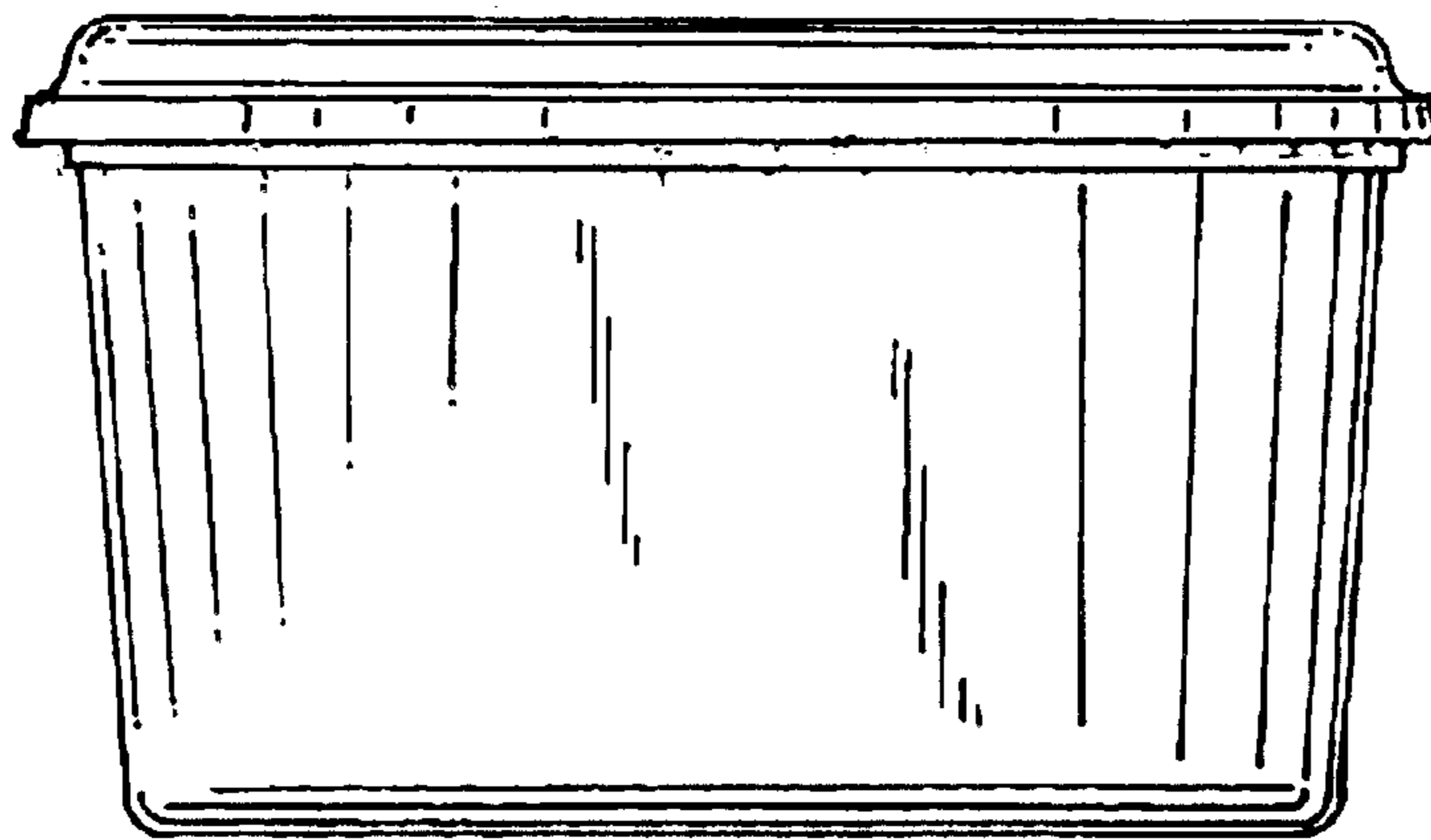

Fig. 20

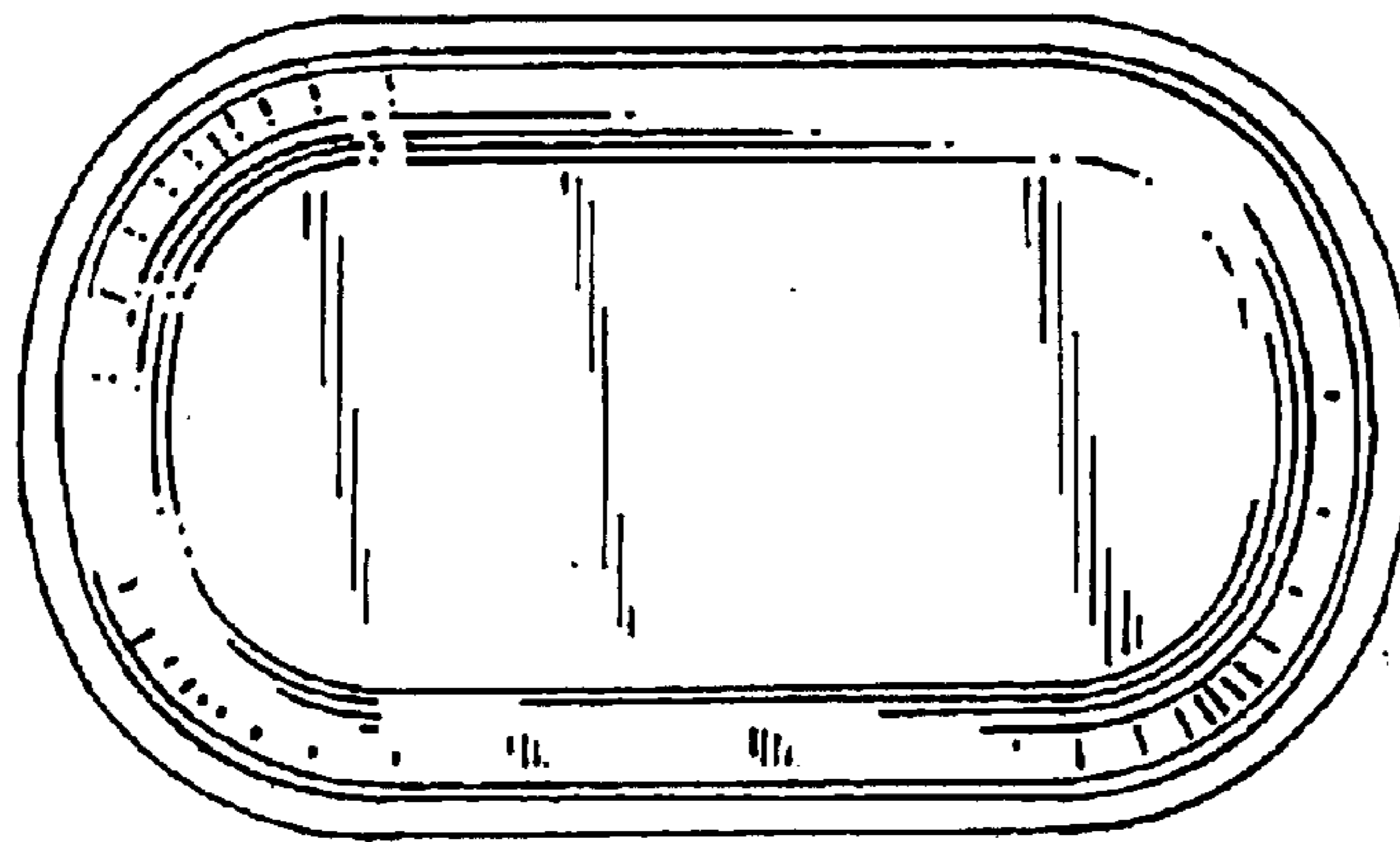

Fig. 21