

US00D502389S

(12) **United States Design Patent**  
**Hong**

(10) **Patent No.: US D502,389 S**  
(45) **Date of Patent: \*\* Mar. 1, 2005**

(54) **MULTI-CONNECTION WAYS HOOK**

(57) **CLAIM**

(76) **Inventor: Zong-Der Hong**, 235 Chung-Ho Box  
8-24, Taipei (TW)

The ornamental design for a multi-connection ways hook, as shown and described.

(\*\*) **Term: 14 Years**

**DESCRIPTION**

(21) **Appl. No.: 29/166,671**

FIG. 1 is a front elevational view of a multi-connection ways hook showing my new design;

(22) **Filed: Sep. 3, 2002**

FIG. 2 is a rear elevational view thereof;

(51) **LOC (7) Cl. .... 08-08**

FIG. 3 is a left side view thereof;

(52) **U.S. Cl. .... D8/367; D8/356**

FIG. 4 is a right side view thereof;

(58) **Field of Search .... D1/120; D8/333,**

FIG. 5 is a top plan view thereof;

D8/356, 367, 370, 383; 24/583.1, 587.1,  
588.1, 594.11, 598.1, 598.2, 598.3, 598.4,  
599.1, 599.2, 599.3, 599.5, 599.6, 599.7,  
599.8, 599.9, 600.1, 600.3, 600.9, 601.5;  
248/231.9, 231.91, 925; 294/82.17, 82.19,  
82.2; D34/33, 35

FIG. 6 is a bottom plan view thereof.

FIG. 7 is a perspective view thereof;

(56) **References Cited**

FIG. 8 is a elevational view showing one application of the present design, where those environmental features illustrated in dashed lines are not claimed in the present design;

**U.S. PATENT DOCUMENTS**

1,144,099	A	*	6/1915	Black	.....	24/599.2
3,480,319	A	*	11/1969	Raschke	.....	294/82.22
3,820,204	A	*	6/1974	Scarpa	.....	24/599.2
D241,118	S	*	8/1976	Schreyer et al.	.....	D8/367
D245,832	S	*	9/1977	Fredriksson	.....	D8/367
4,309,052	A	*	1/1982	Drayton	.....	24/82 R
D439,506	S	*	3/2001	Striebel	.....	D8/367
6,401,312	B1	*	6/2002	Wang	.....	24/600.6

FIG. 9 is a elevational view showing another application of the present design, where those environmental features illustrated in dashed lines are not claimed in the present design;

FIG. 10 is a elevational view showing a further application of the present design, where those environmental features illustrated in dashed lines are not claimed in the present design;

FIG. 11 is a elevational view showing yet another application of the present design, where those environmental features illustrated in dashed lines are not claimed in the present design; and,

FIG. 12 is a elevational view showing still another application of the present design, where those environmental features illustrated in dashed lines are not claimed in the present design.

\* cited by examiner

*Primary Examiner*—Doris V. Coles  
*Assistant Examiner*—Elizabeth A. Albert

**1 Claim, 7 Drawing Sheets**

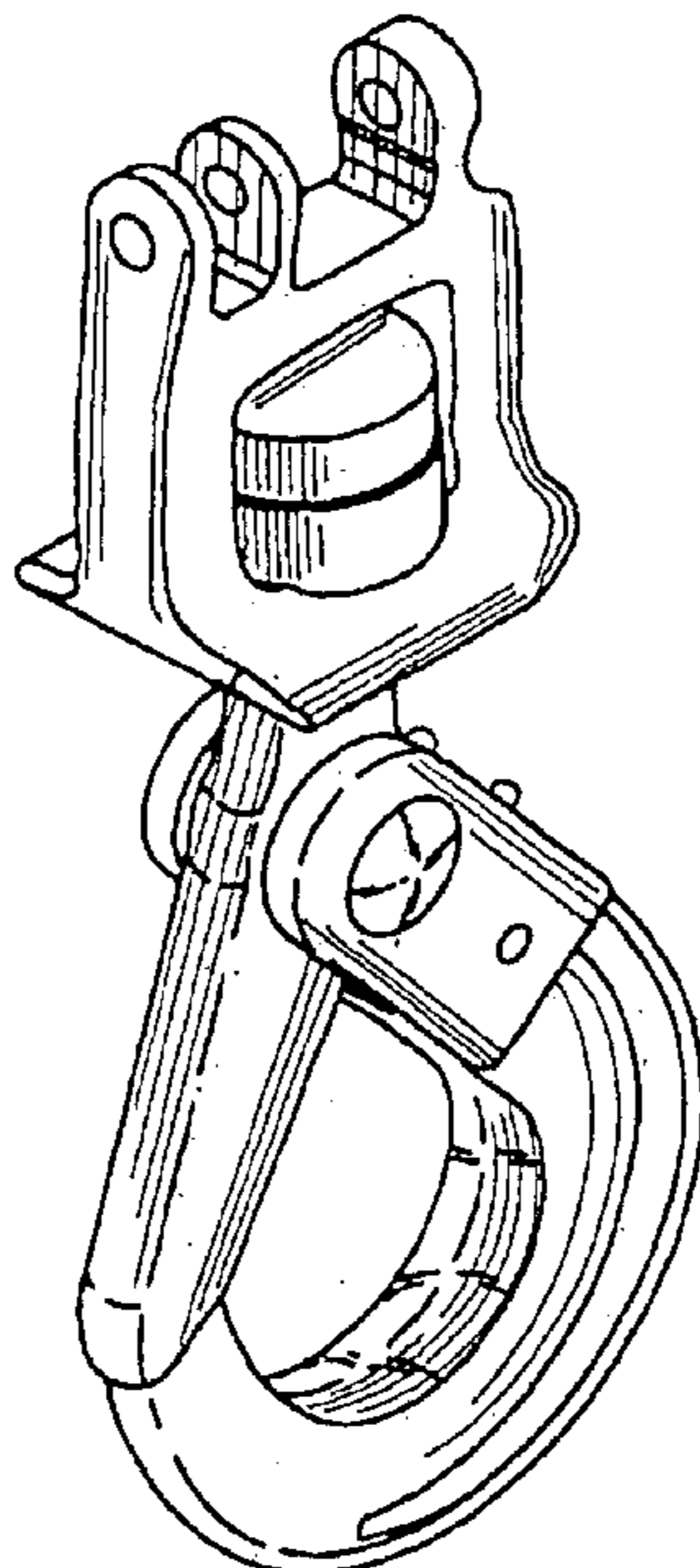

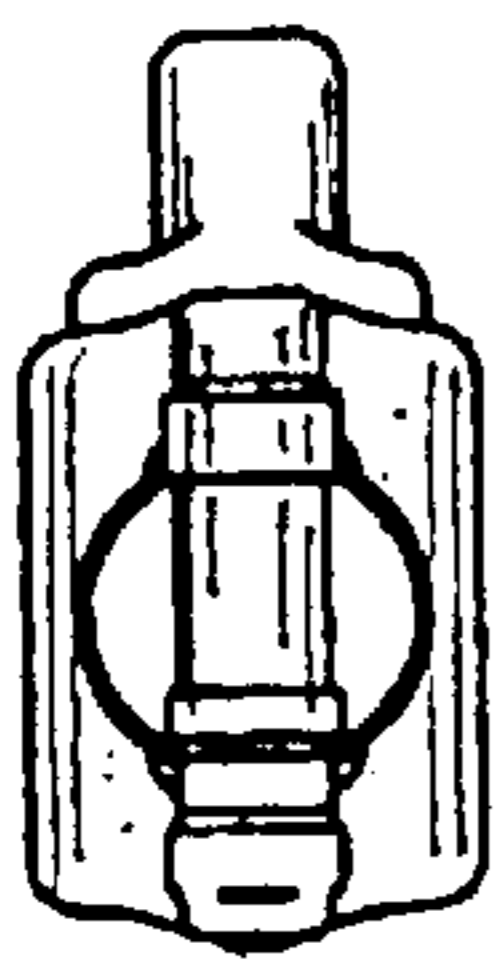

Fig. 5

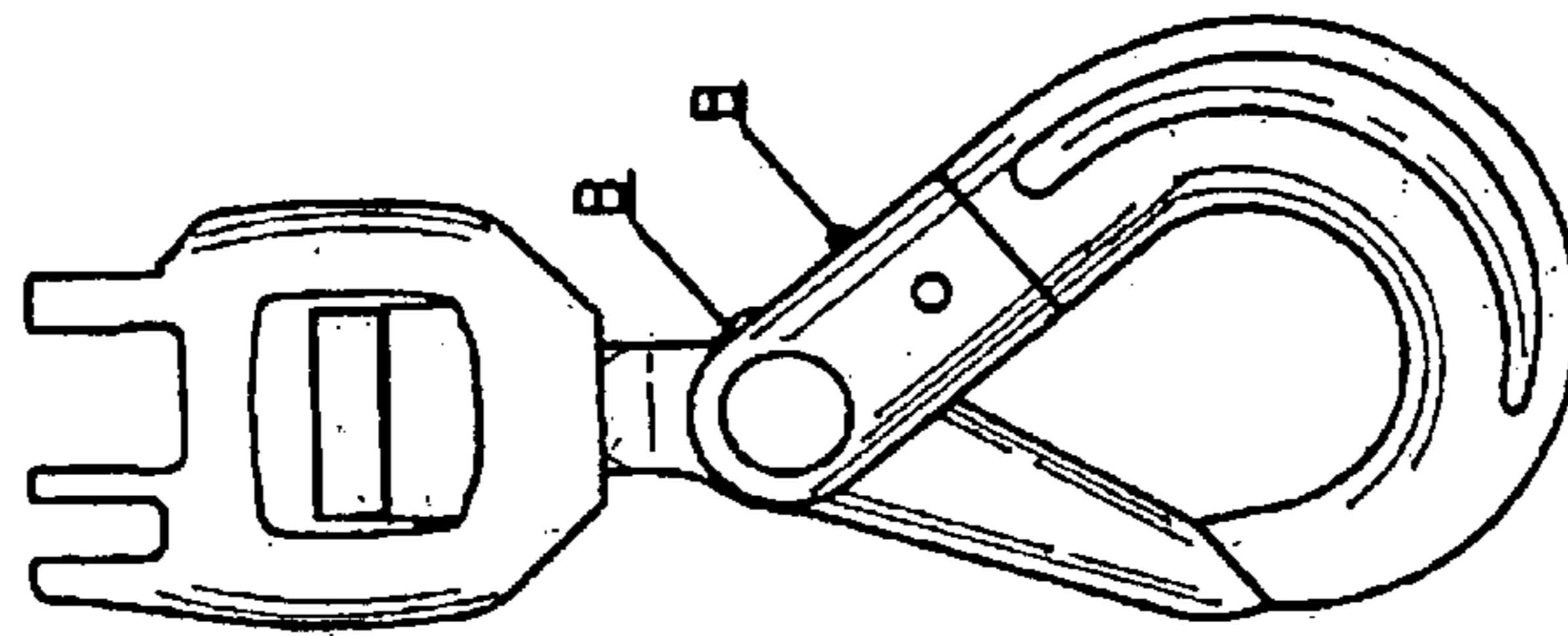

Fig. 1

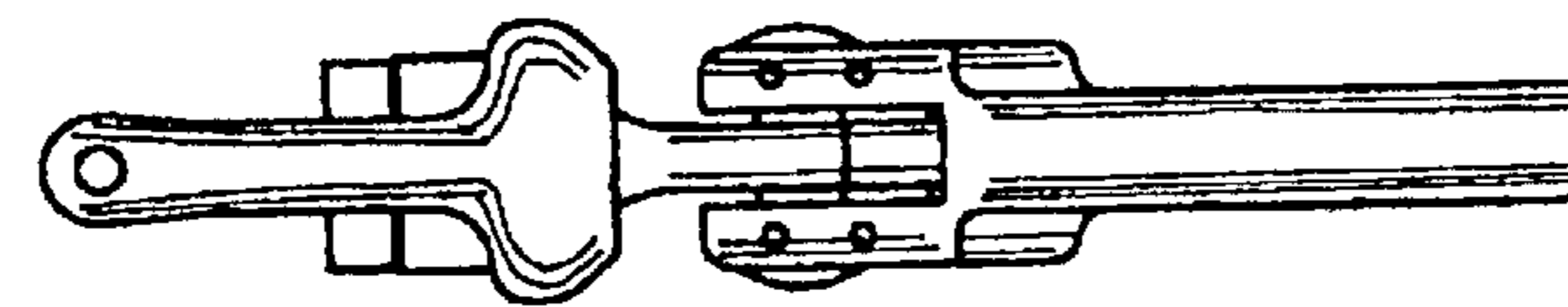

Fig. 3

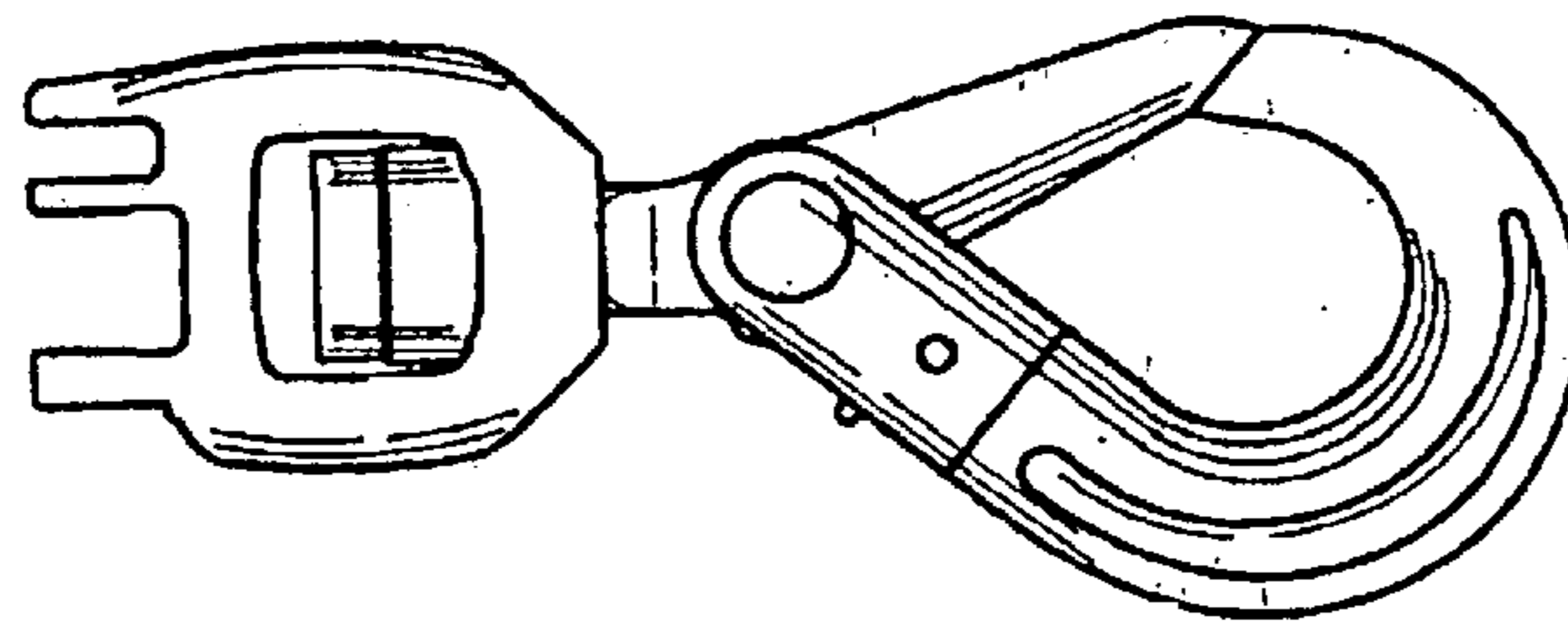

Fig. 2

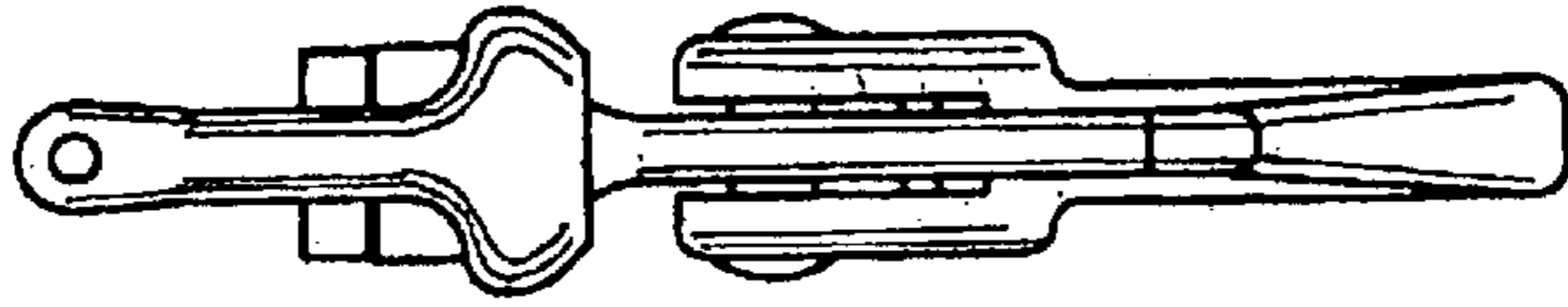

Fig. 4

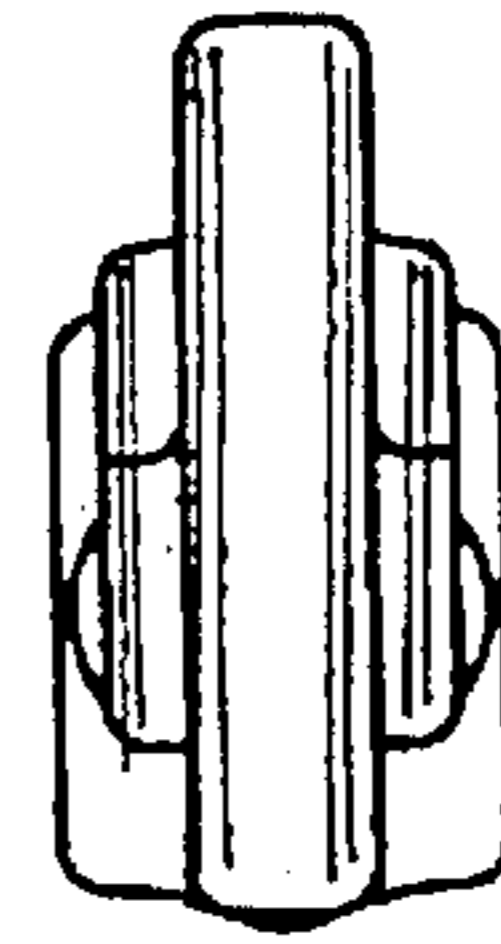

Fig. 6

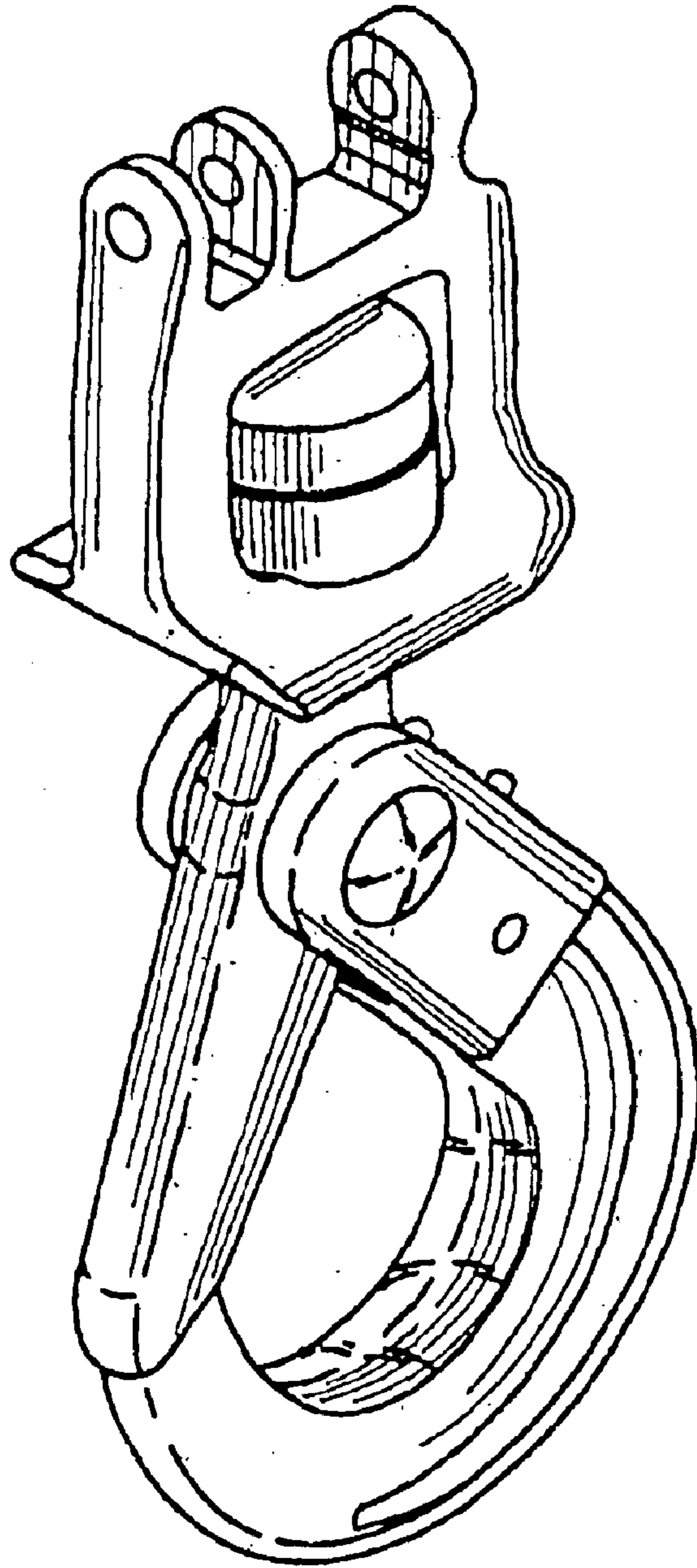

Fig. 7

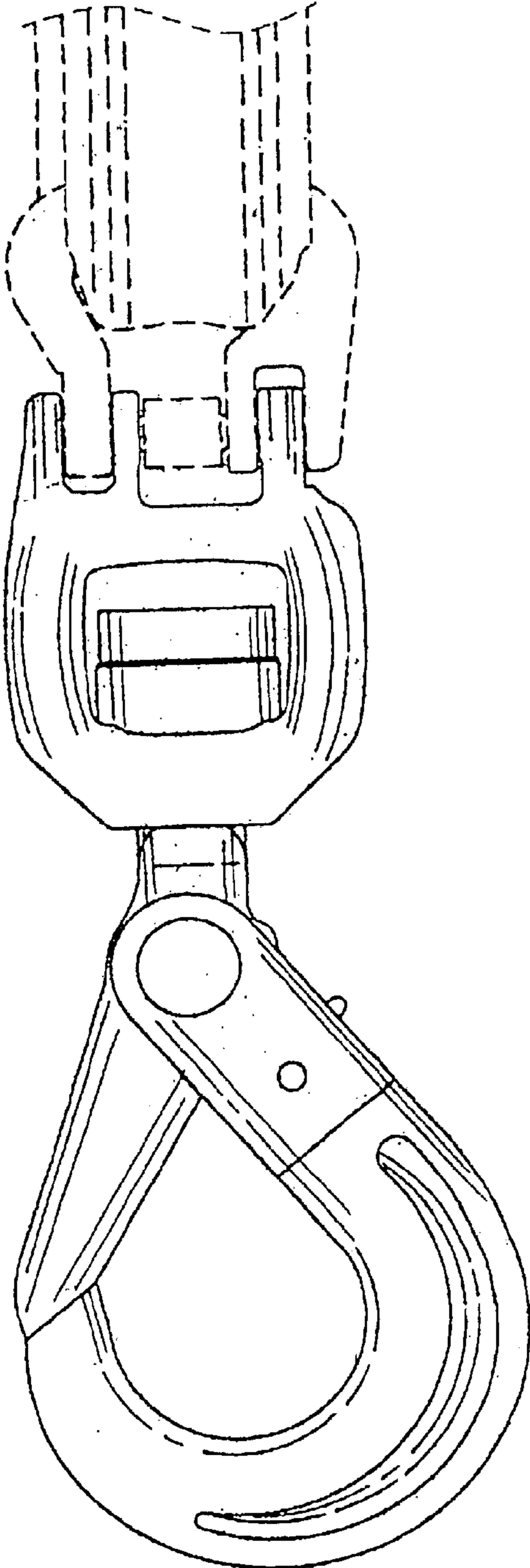

Fig. 8

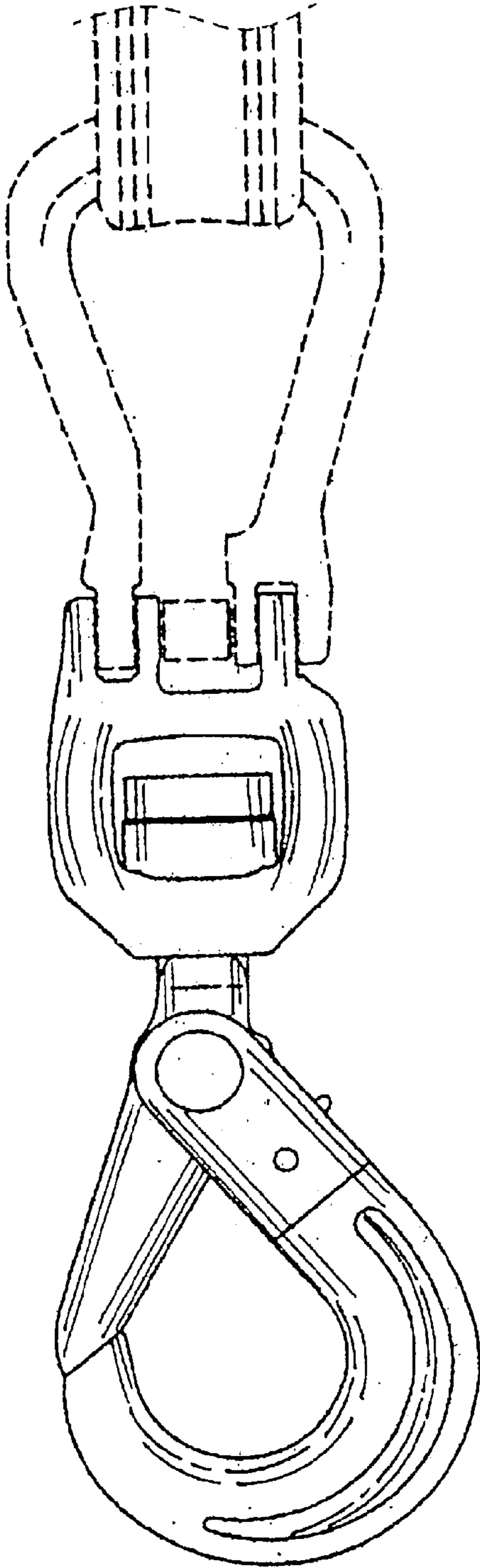

Fig 9

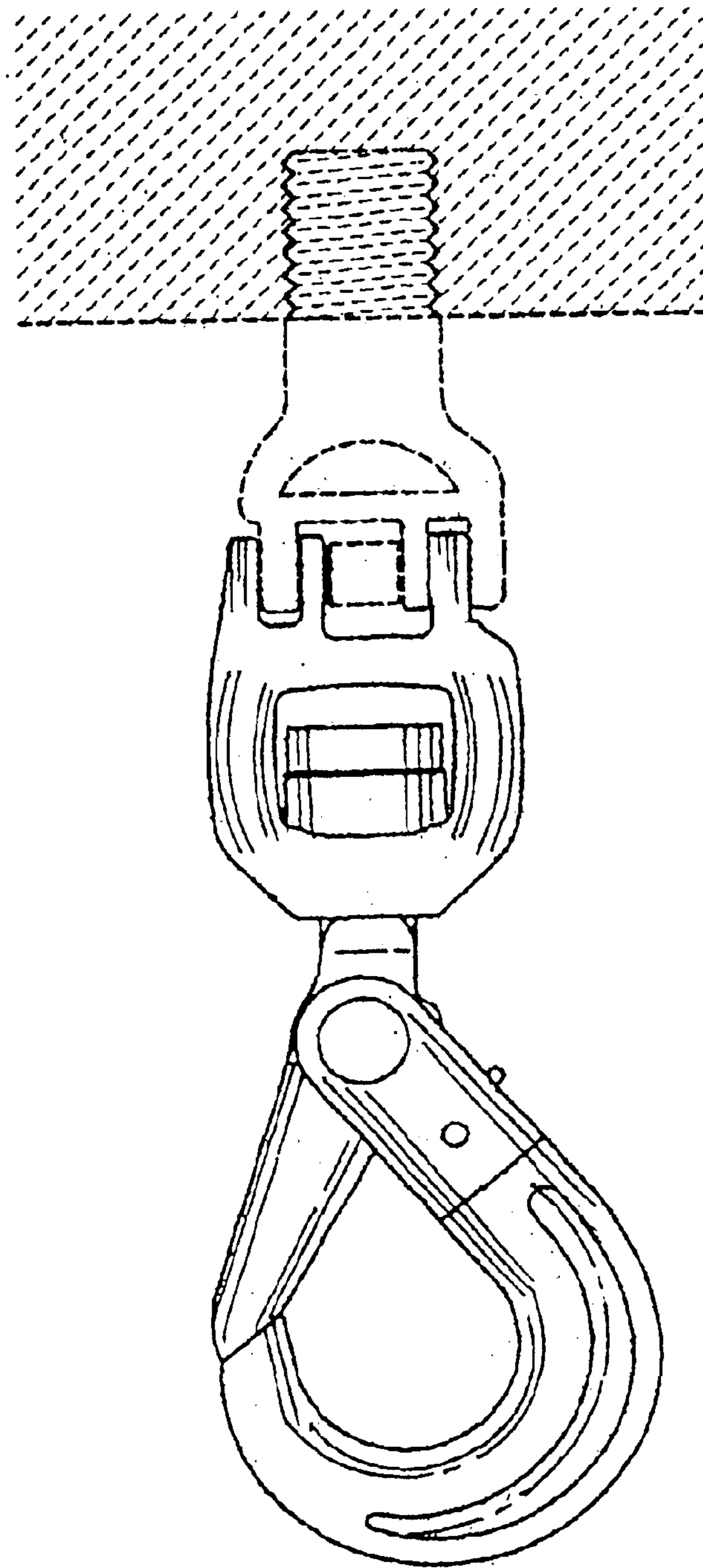

Fig. 10

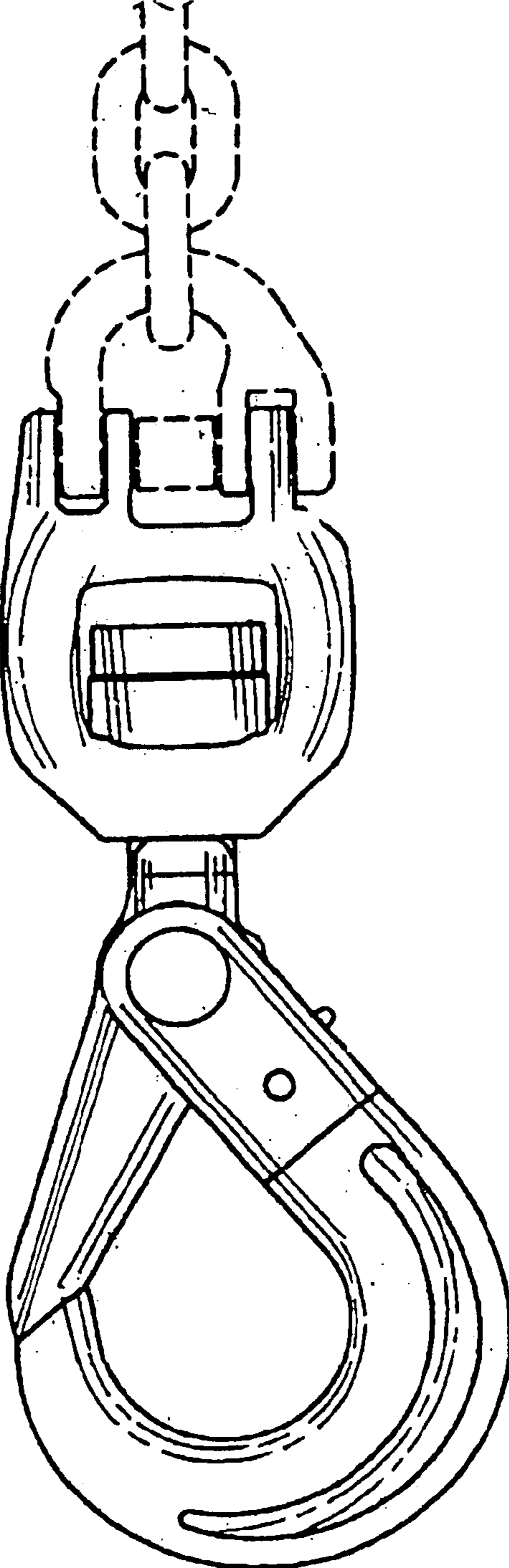

Fig. 11

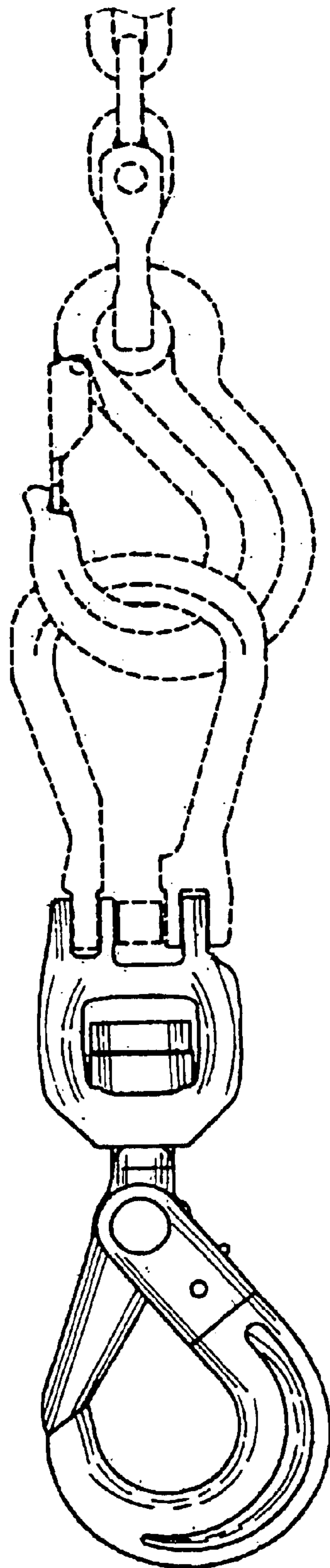

Fig. 12