



US00D502352S

(12) **United States Design Patent** (10) **Patent No.:** **US D502,352 S**
Jacobo (45) **Date of Patent:** **** Mar. 1, 2005**

(54) **MINIDISC AND ACCESSORY HOLDER**

(76) Inventor: **Francisco O. Jacobo**, 1201 N. Vulcan Ave., #1, Encinitas, CA (US) 92024

(**) Term: **14 Years**

(21) Appl. No.: **29/195,974**

(22) Filed: **Dec. 17, 2003**

(51) **LOC (7) Cl.** **06-04**

(52) **U.S. Cl.** **D6/630**

(58) **Field of Search** D6/629-632; 211/40, 211/41.18, 87.01, 90, 134, 186-189; 108/91, 92, 99, 115; 206/387.15, 307.1; 312/9.9, 9.64, 9.48, 9.53

(56) **References Cited**

U.S. PATENT DOCUMENTS

D298,287 S	*	11/1988	Stravitz	D6/629
D320,707 S	*	10/1991	Garfinkle	D6/407
D354,877 S	*	1/1995	Davis et al.	D6/629
D356,463 S	*	3/1995	Davis et al.	D6/629
D364,304 S	*	11/1995	Weisburn et al.	D6/632
D450,971 S	*	11/2001	Lee	D6/630
D454,463 S	*	3/2002	Stitt	D6/630

* cited by examiner

Primary Examiner—Cathron Brooks

(74) *Attorney, Agent, or Firm*—Murphey & Murphey, A.P.C.

(57) **CLAIM**

The ornamental design for a minidisc and accessory holder, as shown.

DESCRIPTION

FIG. 1 is a perspective view of the minidisc and accessory holder showing my new design;

FIG. 2 is a front view of the minidisc and accessory holder showing my new design;

FIG. 3 is a top view of the minidisc and accessory holder showing my new design;

FIG. 4 is a bottom view of the minidisc and accessory holder showing my new design;

FIG. 5 is a back view of the minidisc and accessory holder showing my new design;

FIG. 6 is a side view of the minidisc and accessory holder showing my new design;

FIG. 7 is another side view of the minidisc and accessory holder showing my new design;

FIG. 8 is a front view of another embodiment to the minidisc and accessory holder showing my new design;

FIG. 9 is a side view of an embodiment of the minidisc and accessory holder showing my new design;

FIG. 10 is another side view of an embodiment of the minidisc and accessory holder showing my new design;

FIG. 11 is front view of another embodiment of the minidisc and accessory holder showing my new design;

FIG. 12 is a front view of another embodiment of the minidisc and accessory holder showing my new design; and,

FIG. 13 is a front view of another embodiment of the minidisc and accessory holder showing my new design.

1 Claim, 6 Drawing Sheets

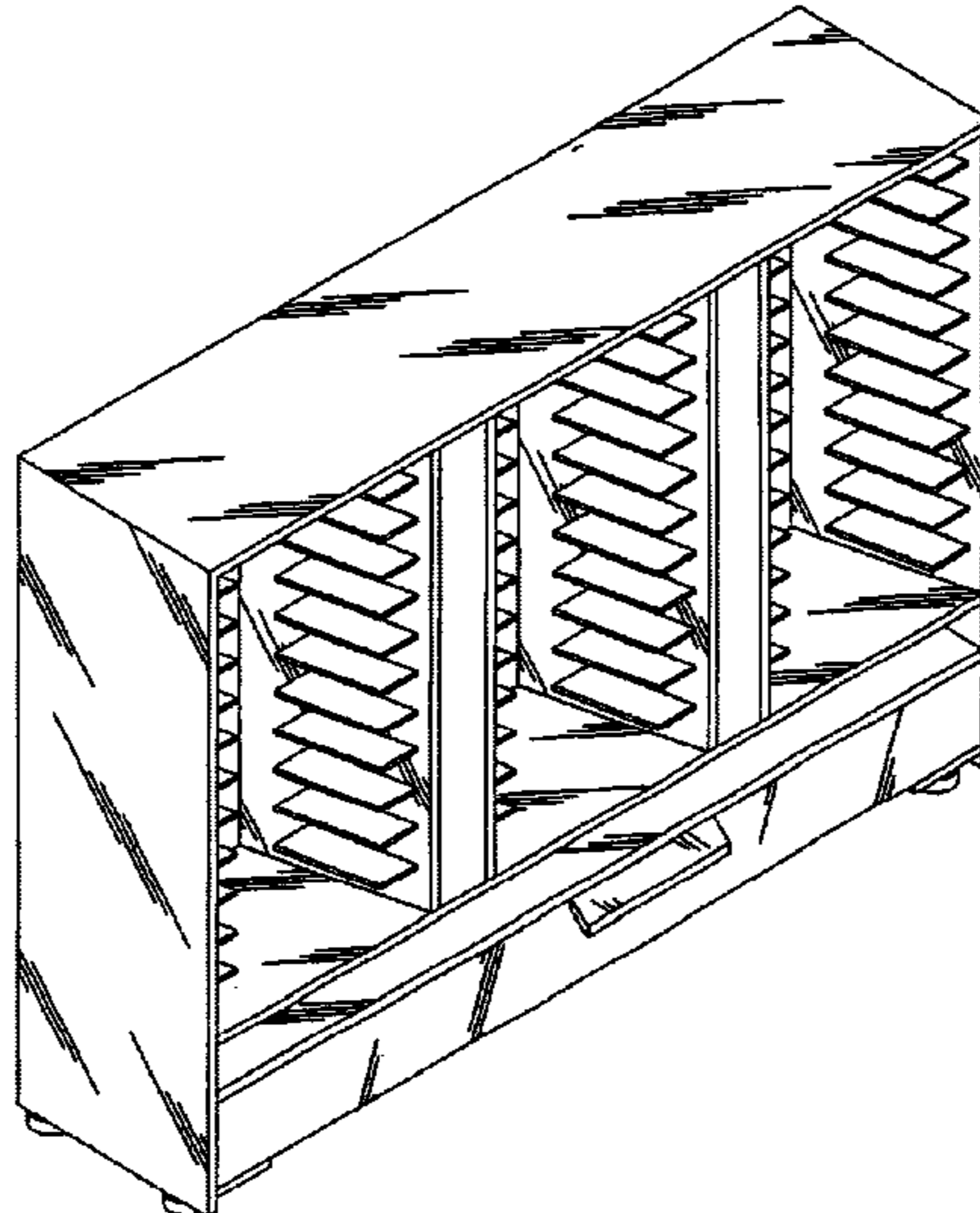

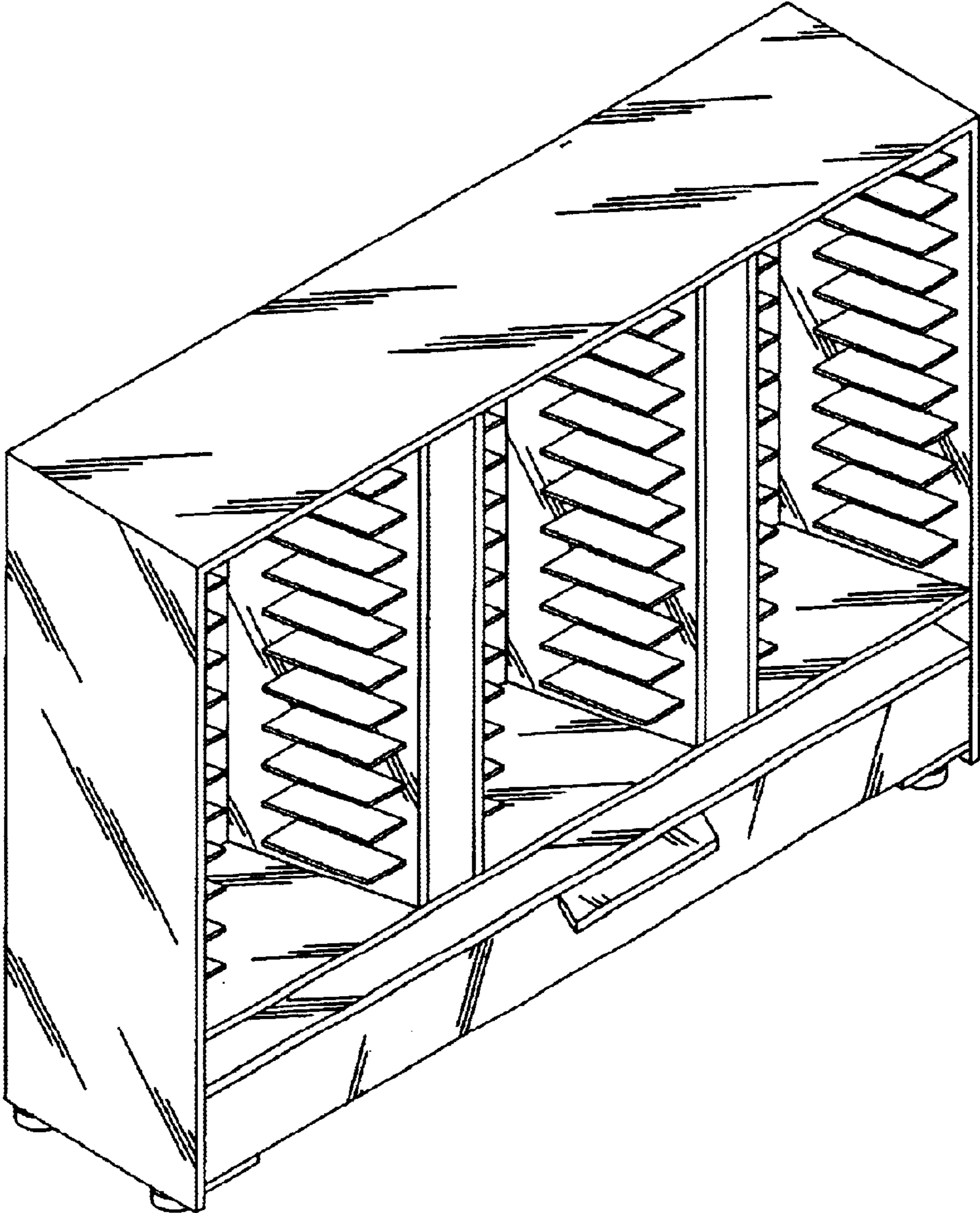

Figure 1

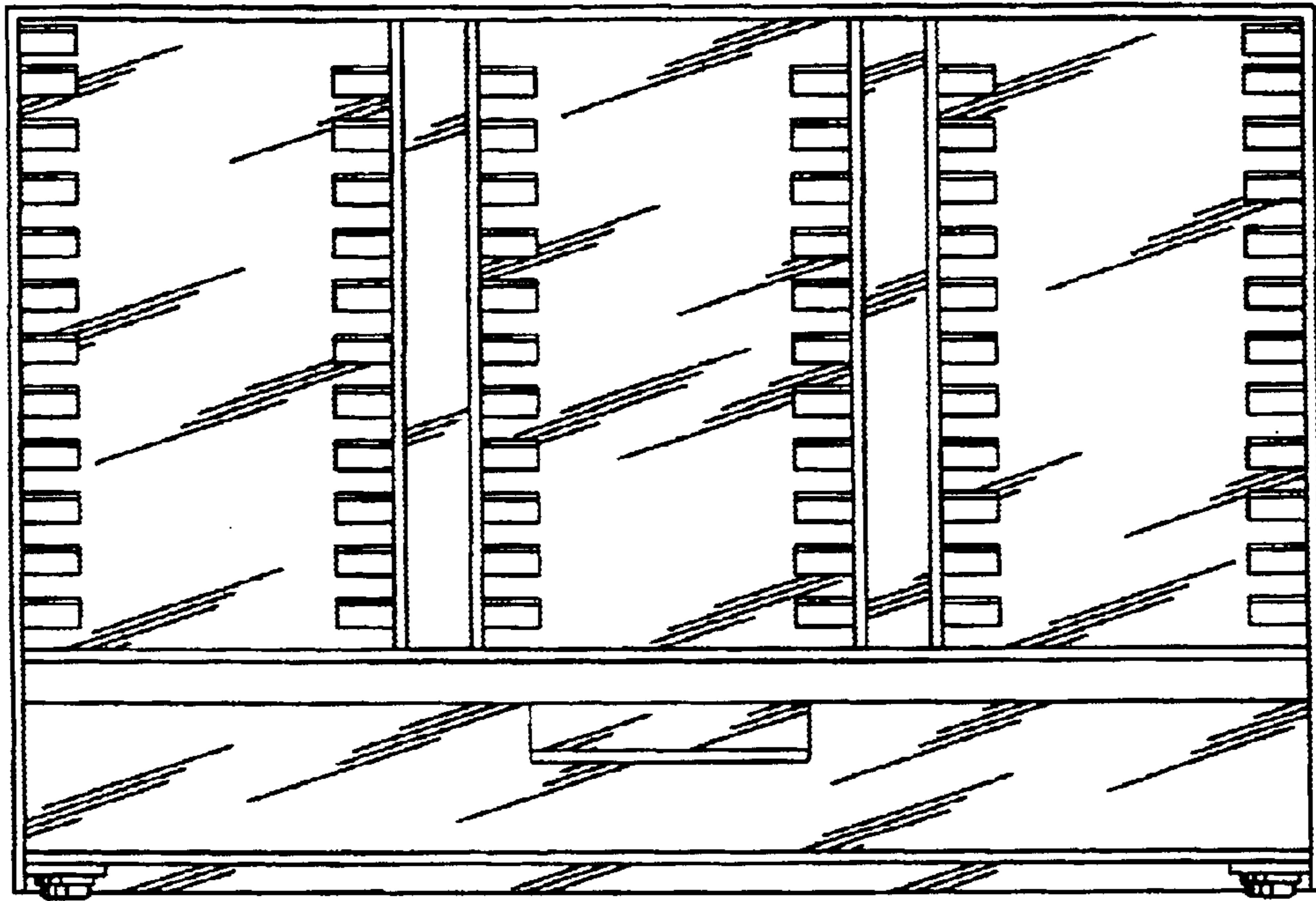

Figure 2

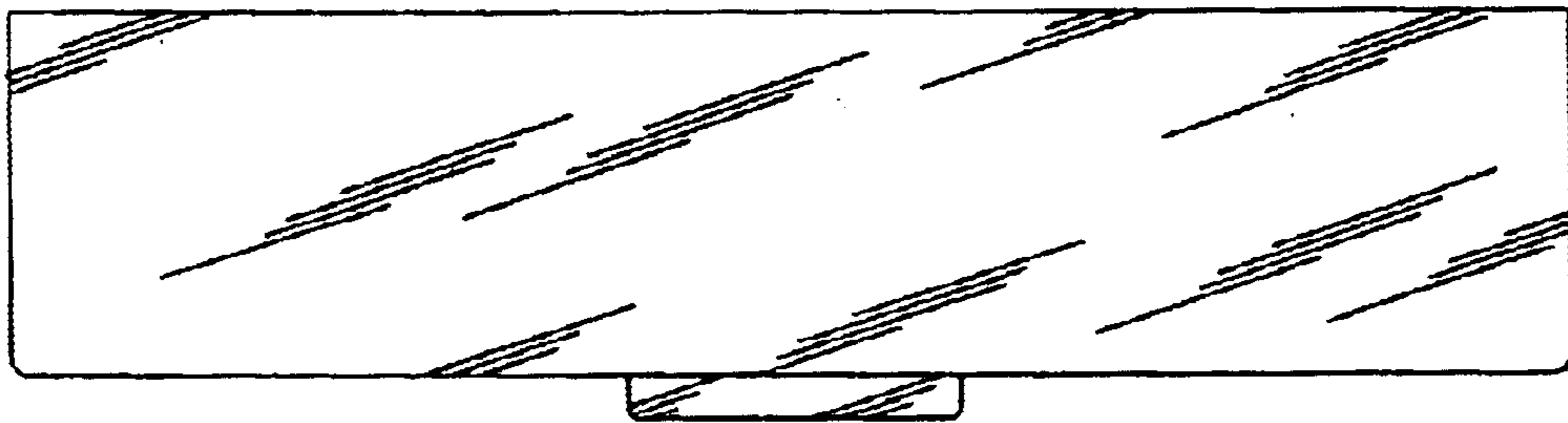

Figure 3

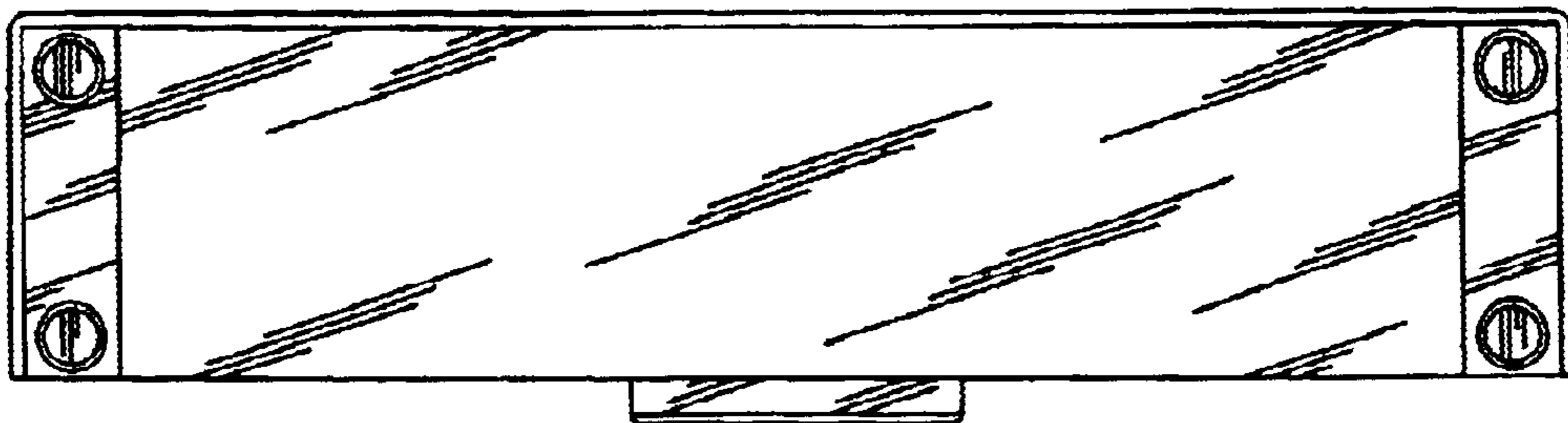

Figure 4

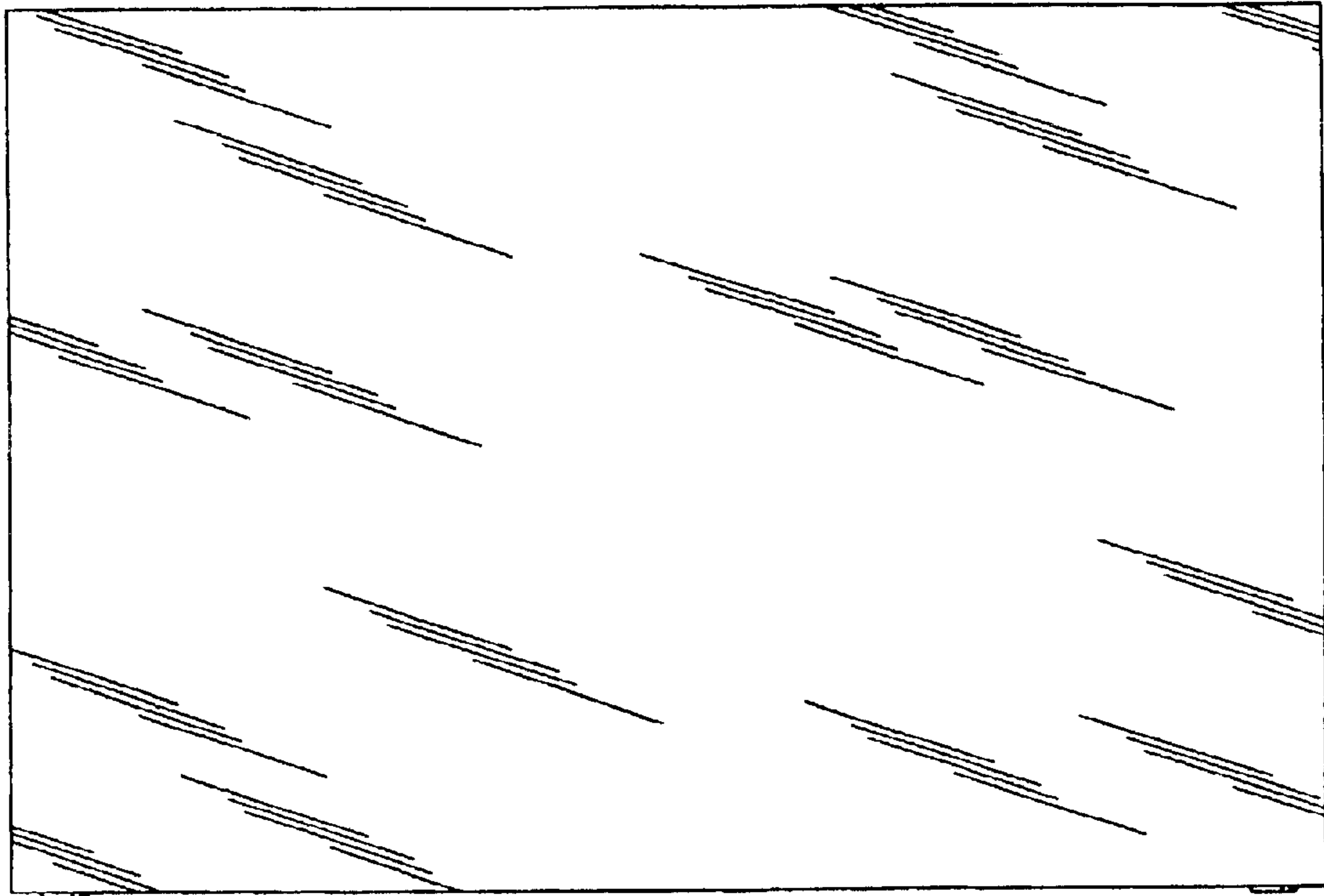

Figure 5

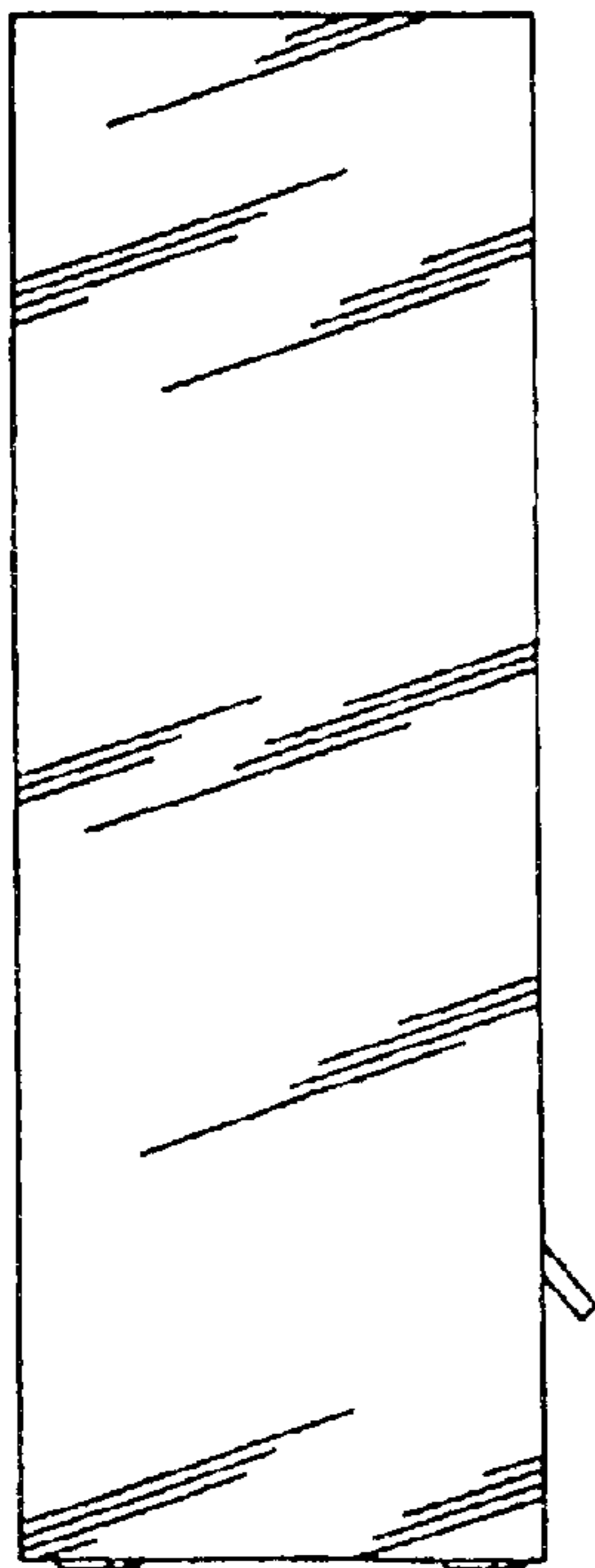

Figure 6

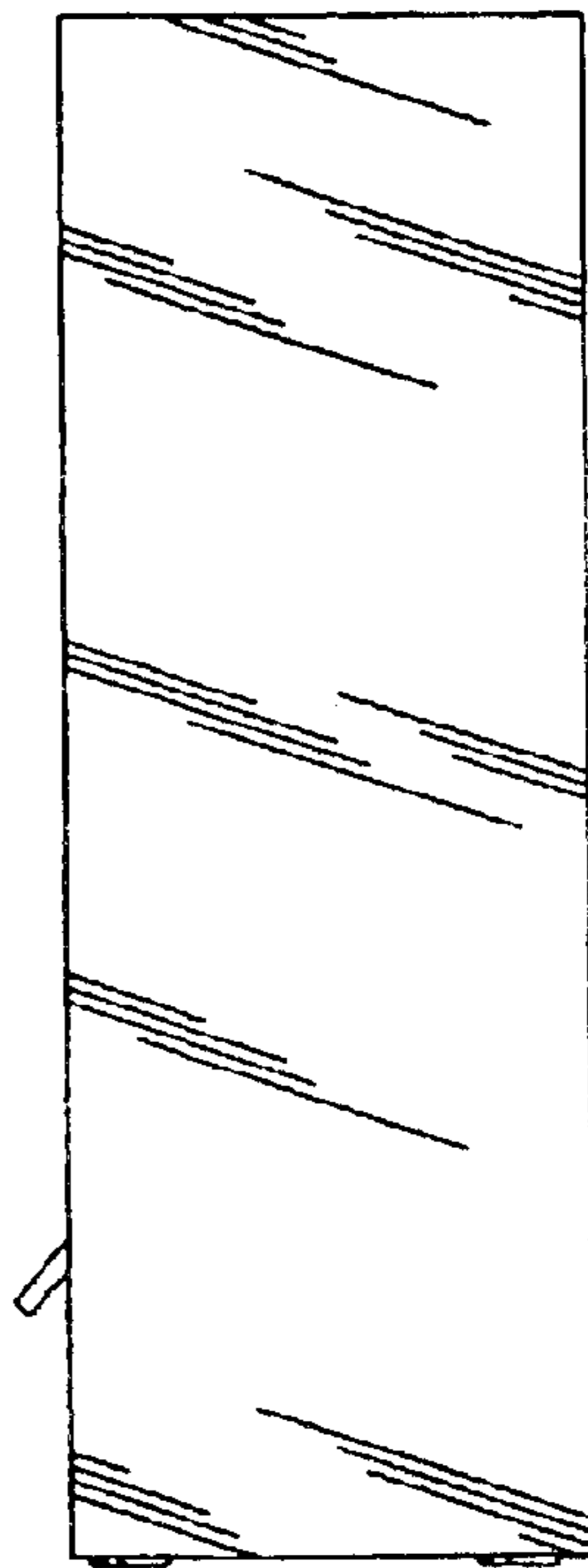

Figure 7

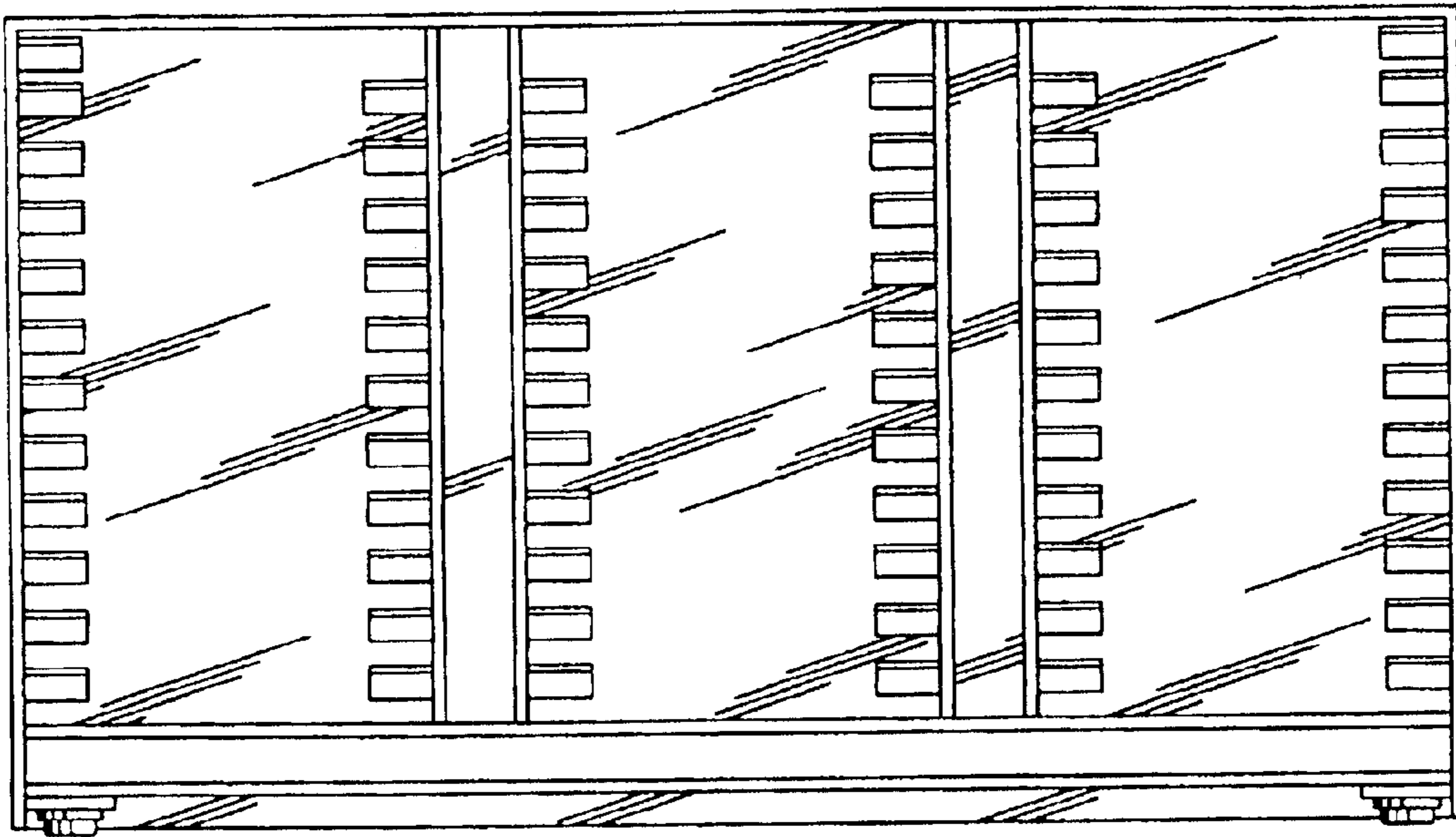

Figure 8

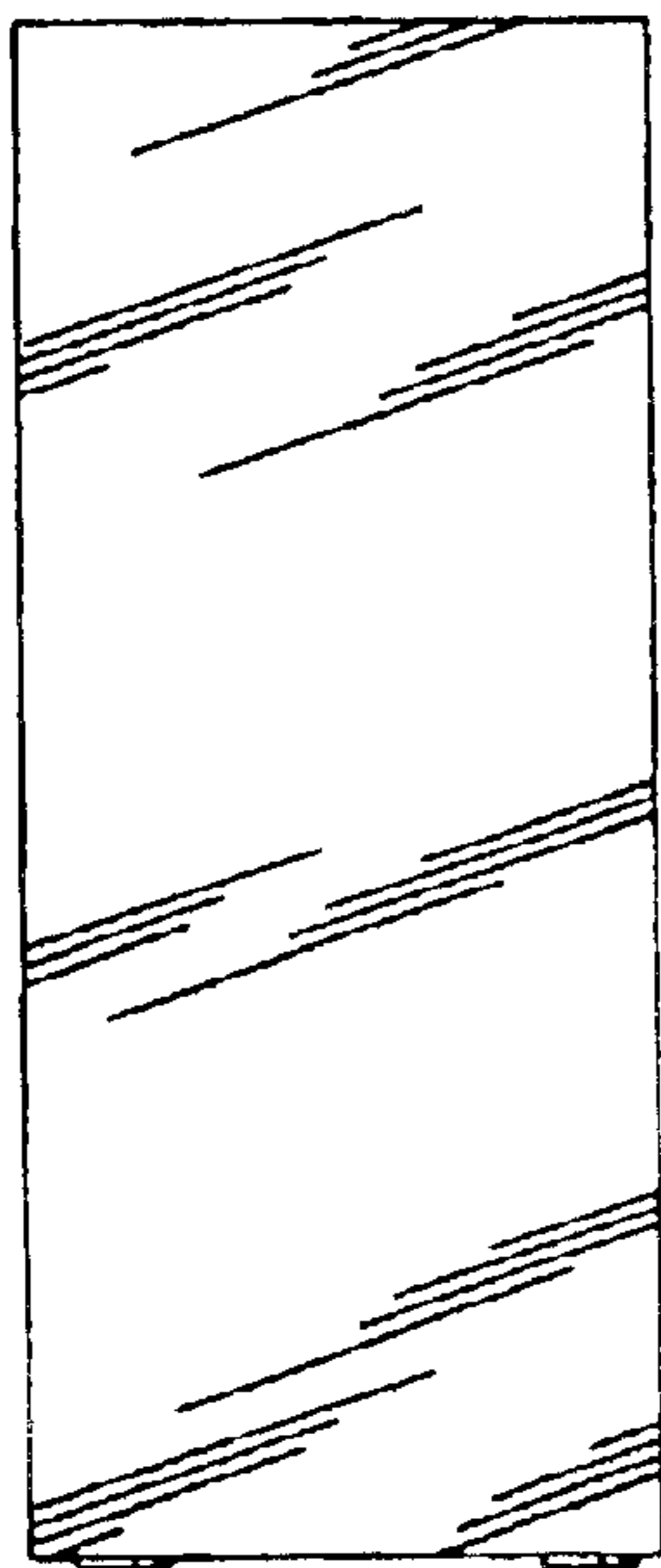

Figure 9

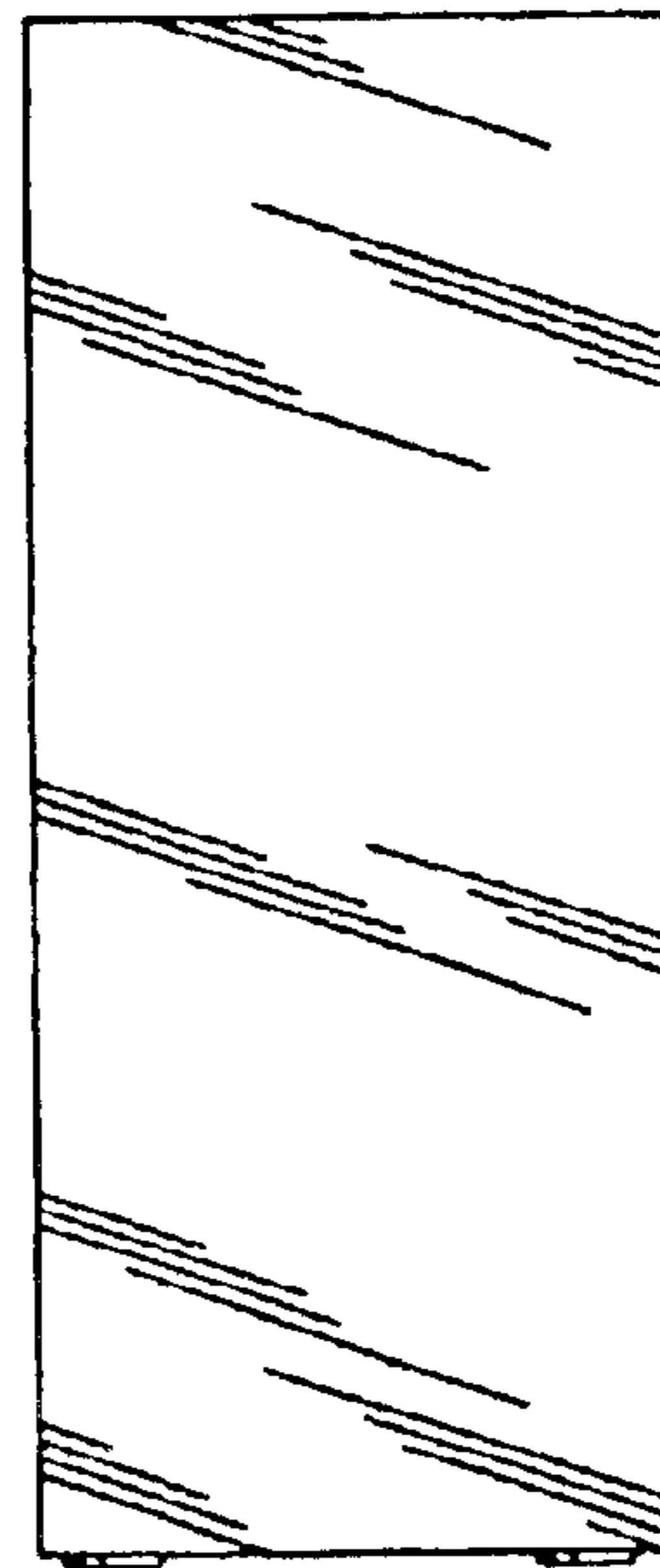

Figure 10

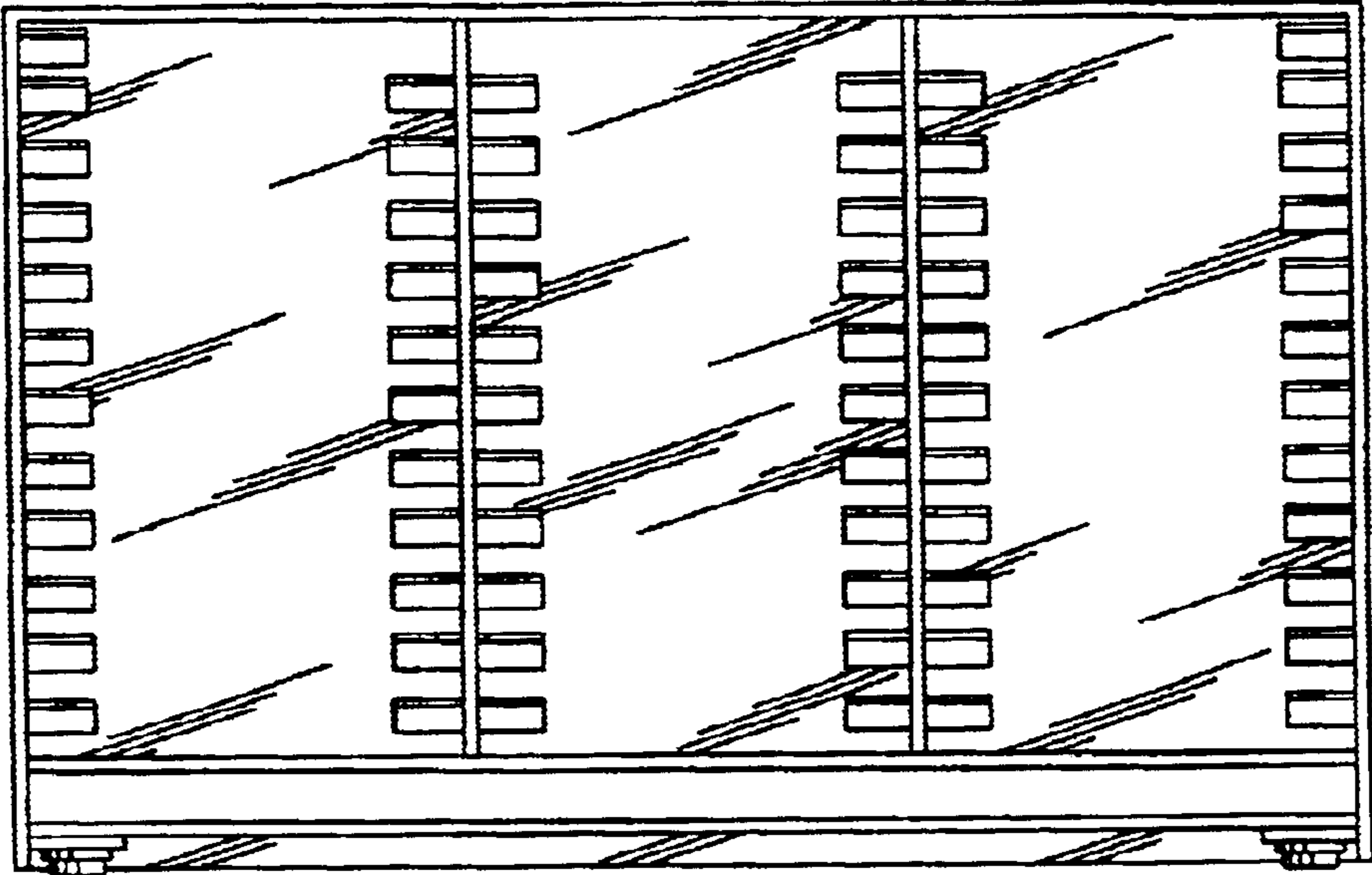

Figure 11

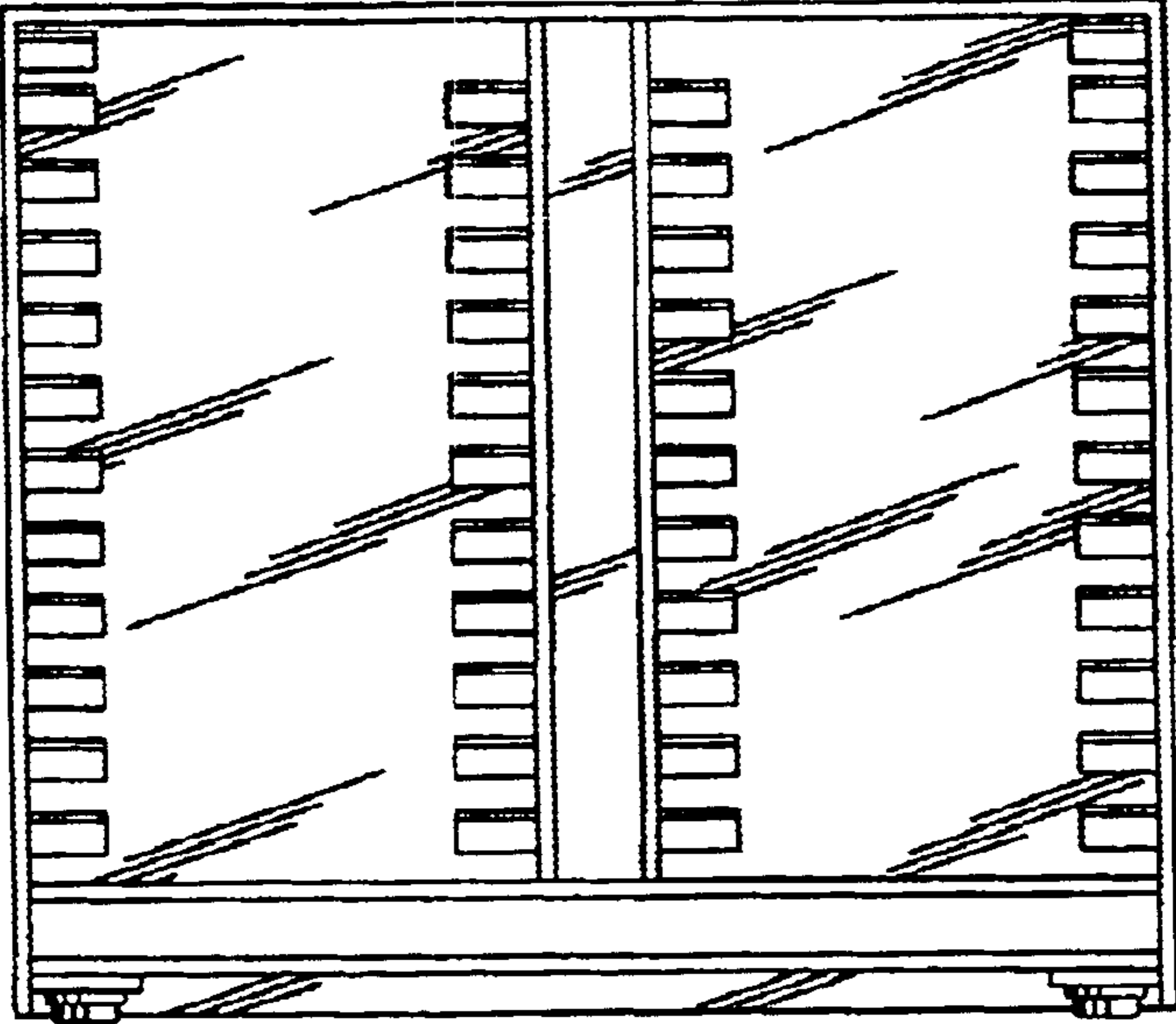

Figure 12

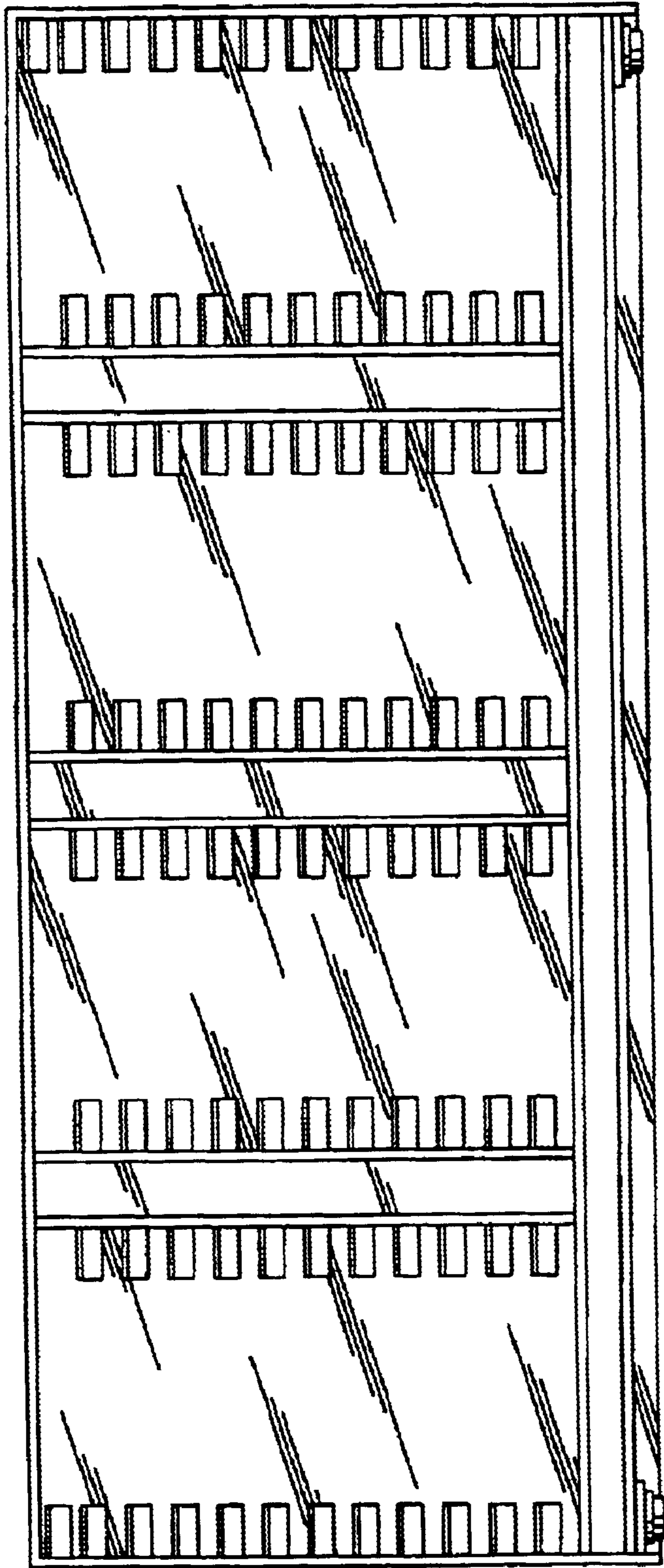

Figure 13