

US00D502077S

(12) **United States Design Patent**  
**Hasegawa**

(10) **Patent No.:** **US D502,077 S**  
(45) **Date of Patent:** **\*\* Feb. 22, 2005**

(54) **SCISSORS**  
(75) Inventor: **Katsumi Hasegawa, Seki (JP)**  
(73) Assignee: **KAI R & D Center Co., Ltd., Gifu-ken (JP)**  
(\*\*) Term: **14 Years**

JP S-1126241 9/2001  
\* cited by examiner

*Primary Examiner*—Clare E Heflin  
(74) *Attorney, Agent, or Firm*—Posz & Bethards, PLC

(21) Appl. No.: **29/198,270**  
(22) Filed: **Jan. 29, 2004**  
(30) **Foreign Application Priority Data**

Aug. 5, 2003 (JP) ..... 2003-022761

(51) **LOC (7) Cl.** ..... **08-03**  
(52) **U.S. Cl.** ..... **D8/107; D8/57**  
(58) **Field of Search** ..... **D8/57, 107; 7/135, 7/136; 30/131, 195, 358, 229-262**

(57) **CLAIM**

The ornamental design for scissors, as shown and described.

**DESCRIPTION**

FIG. 1 is a perspective view seen from the front, bottom plan and right side of a pair of scissors of the present invention; FIG. 2 is a perspective view seen from the rear, top plan and right side thereof; FIG. 3 is a front view thereof; FIG. 4 is a rear view thereof; FIG. 5 is a top plan view thereof; FIG. 6 is a bottom plan view thereof; FIG. 7 is a right side view thereof; FIG. 8 is a left side view thereof; FIG. 9 is a partial enlarged view of the A—A and B—B portion in FIG. 3; FIG. 10 is a cross-sectional view taken along line 10—10 in FIG. 5 of the A—A and B—B portion in FIG. 3; FIG. 11 is a cross-sectional view taken along line 11—11 of FIG. 9; FIG. 12 is a referential partial enlarged view of the A—A and B—B portion in FIG. 3; and, FIG. 13 is a cross-sectional view taken along the line 13 in FIG. 12.  
The broken lines in FIGS. 1 through 13 are shown for illustrative purposes only and form no part of the claimed design.

(56) **References Cited**

**U.S. PATENT DOCUMENTS**

404,169 A \* 5/1889 Clark ..... 30/146  
D238,141 S \* 12/1975 Kahn ..... D8/57  
5,119,561 A \* 6/1992 Olds ..... 30/254  
D472,121 S \* 3/2003 Wolff ..... D8/57  
2003/0140502 A1 \* 7/2003 Aiston et al. .... 30/260

**FOREIGN PATENT DOCUMENTS**

JP S-578448 3/1982  
JP S-948458 12/1995  
JP S-1010591 3/1998  
JP S-1019297 6/1998  
JP S-1019298 6/1998  
JP S-1033594 12/1998

**1 Claim, 4 Drawing Sheets**

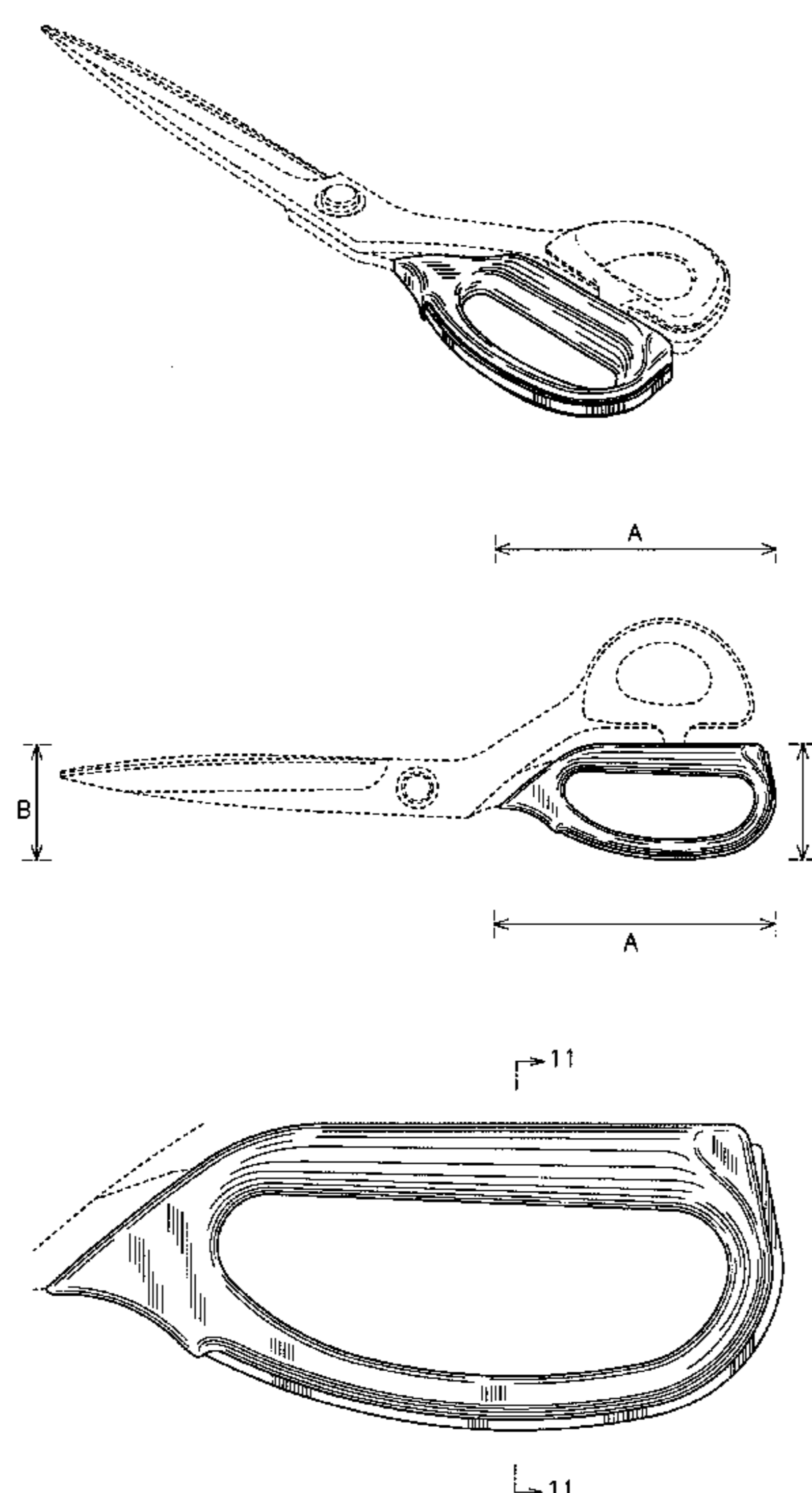

Fig.1

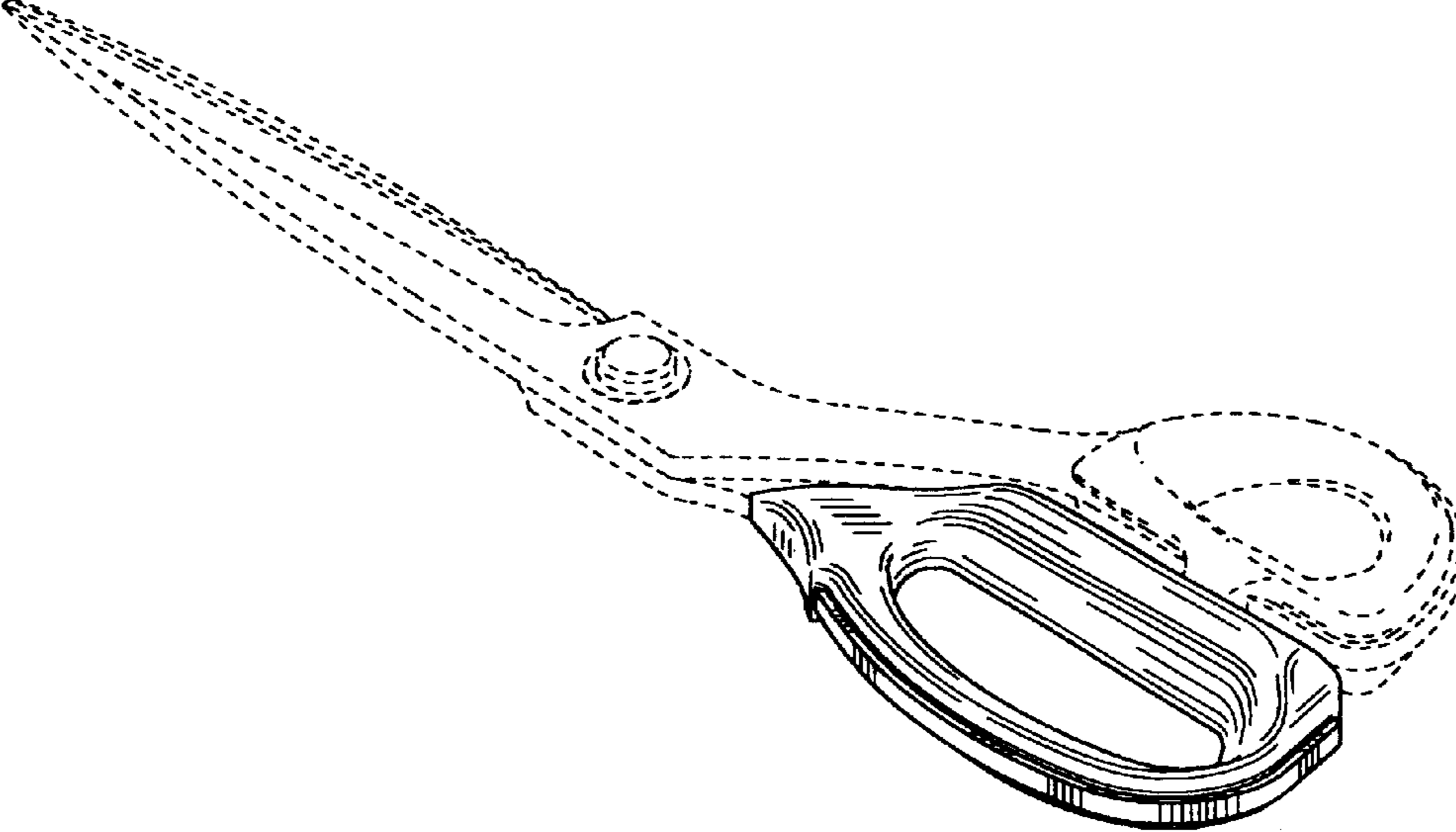

Fig.2

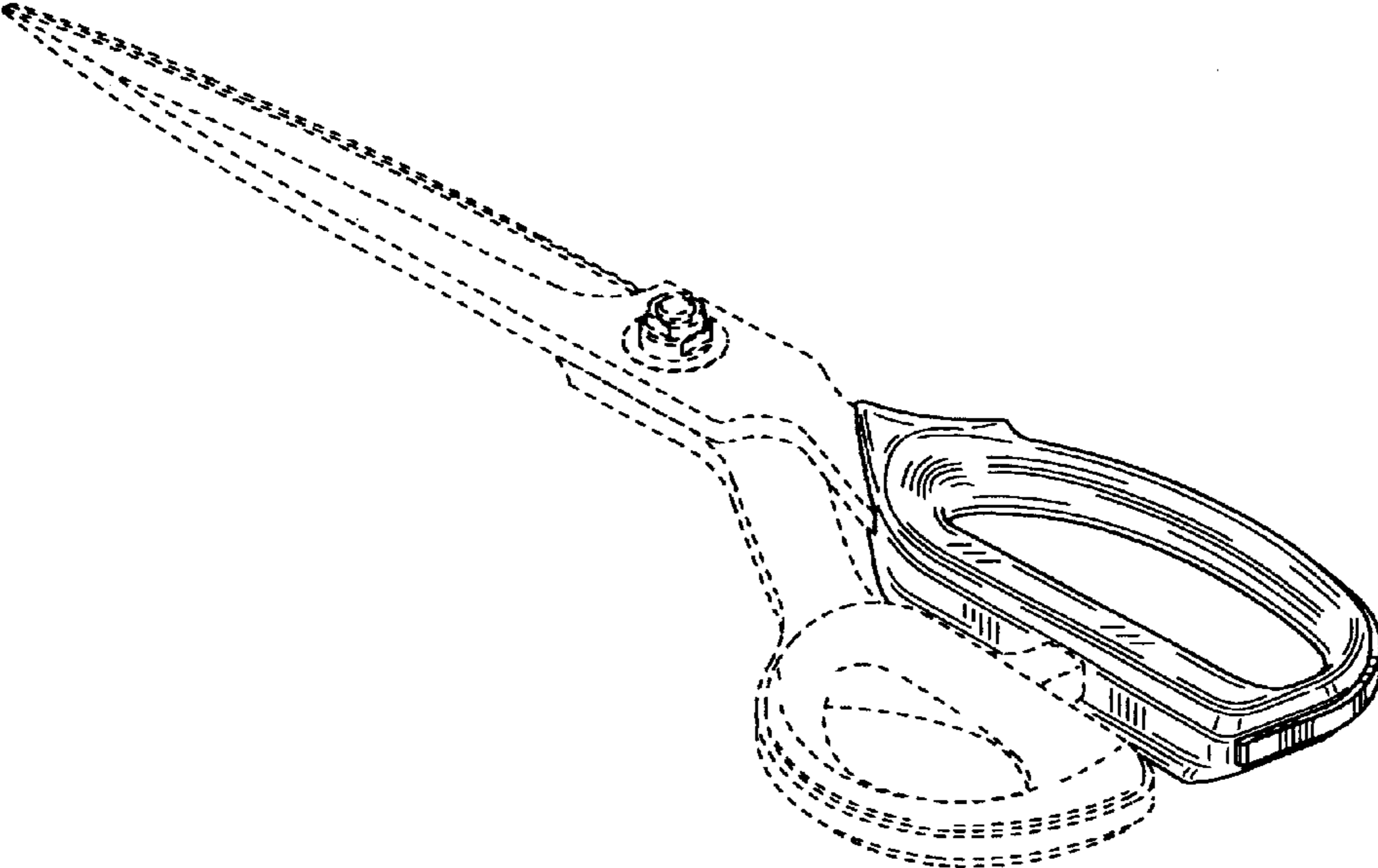

Fig.3

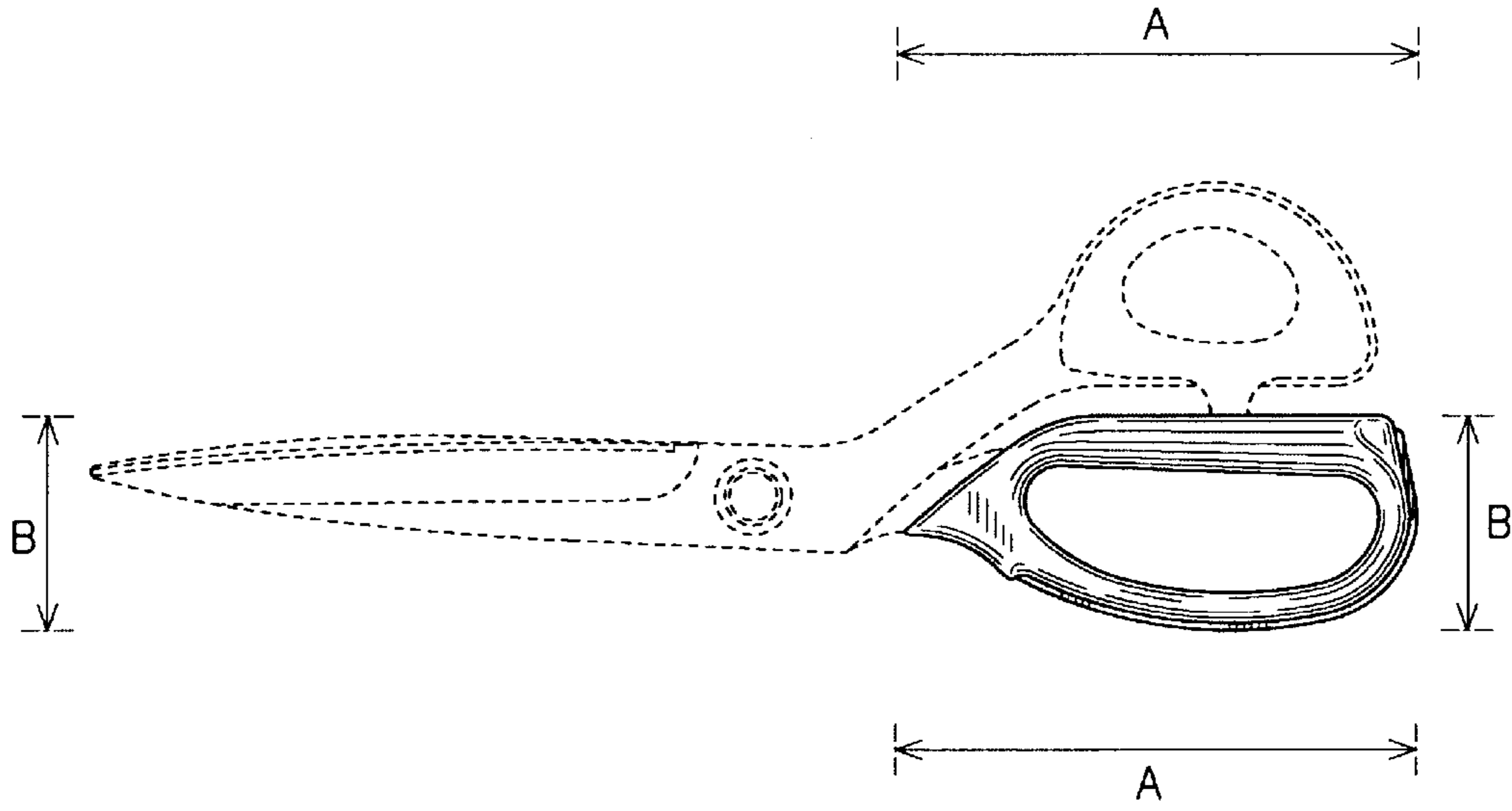

Fig.4

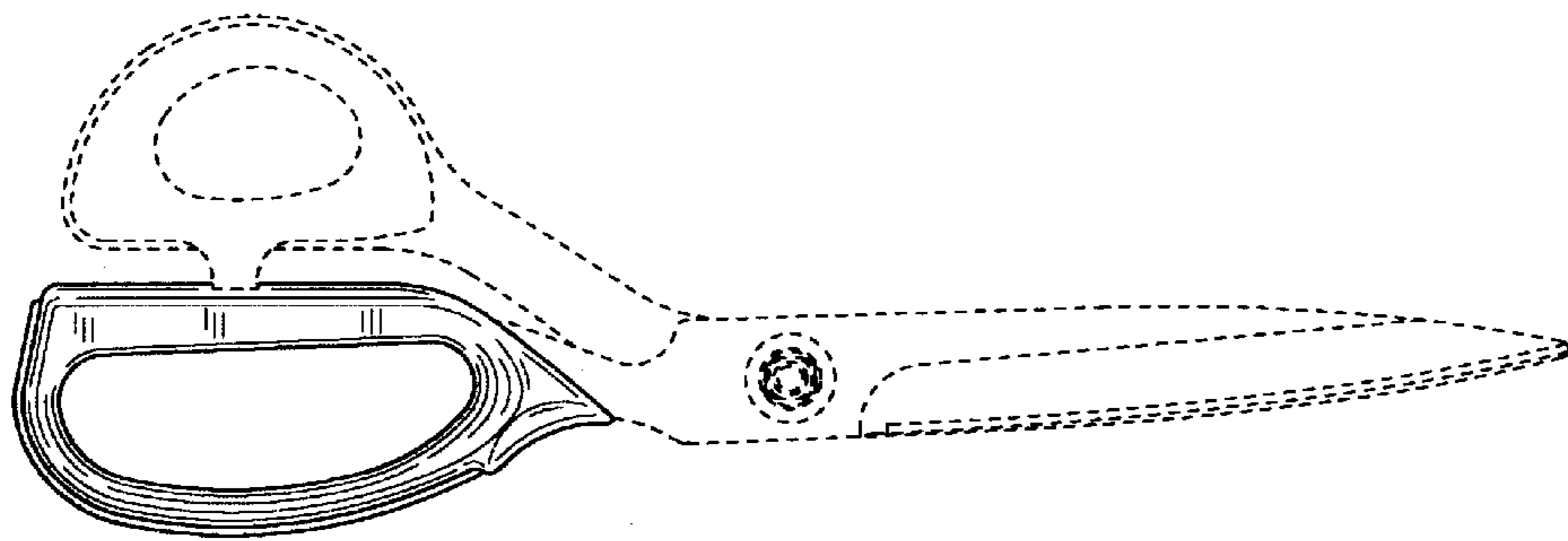

Fig.5

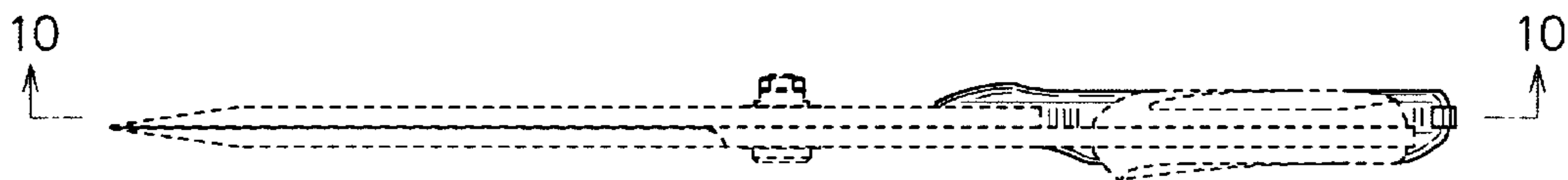

Fig.6



Fig.7



Fig.8



Fig.9

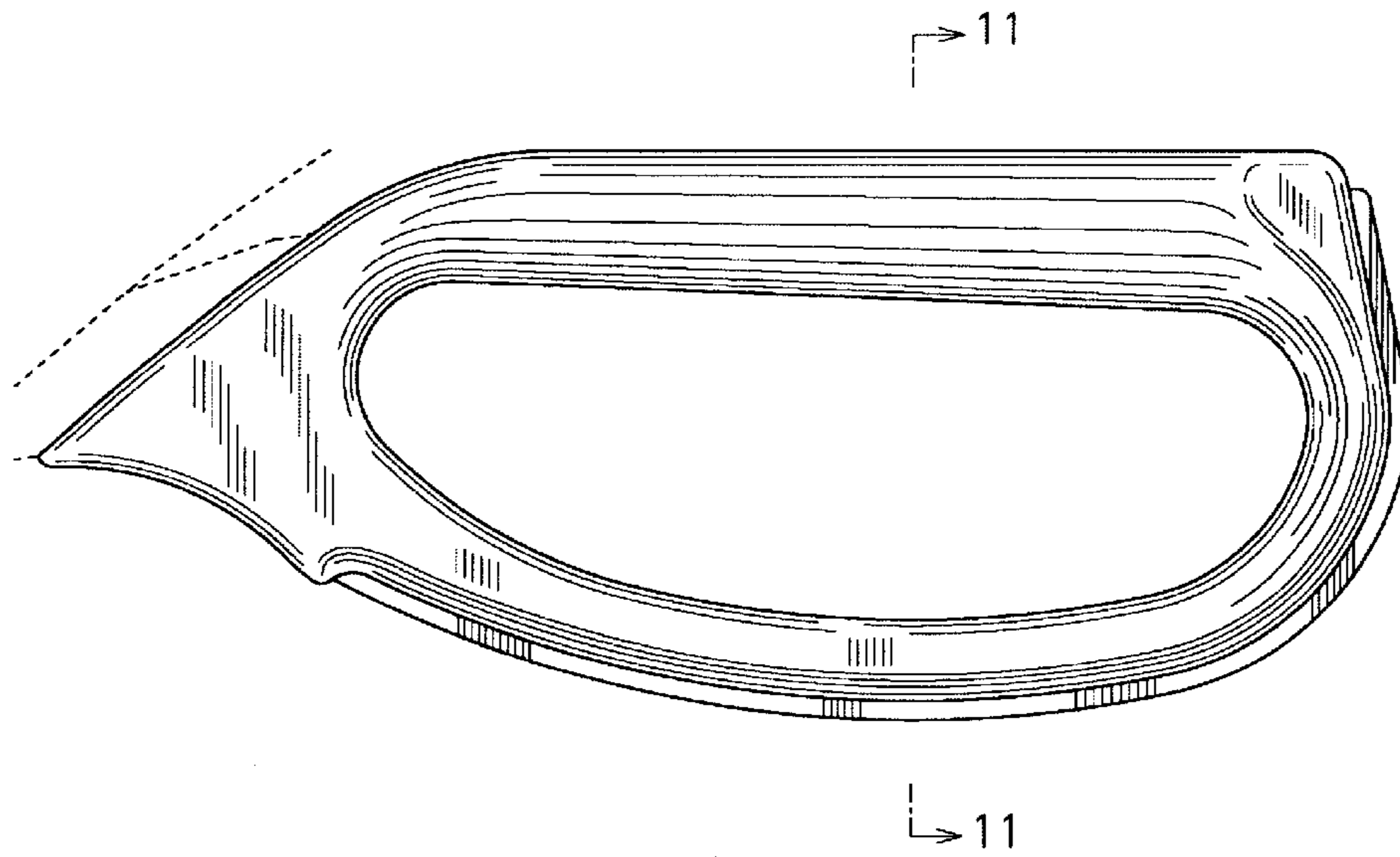

Fig.10

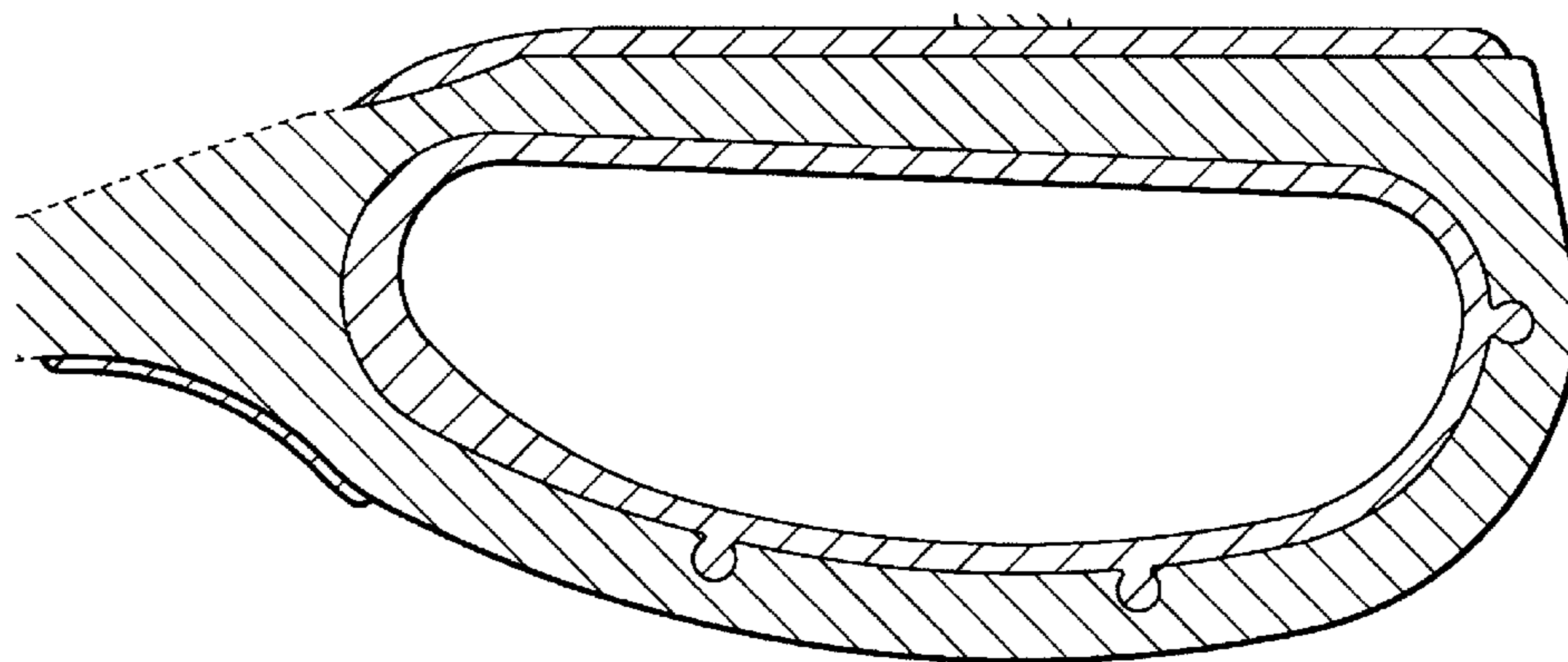

Fig.11

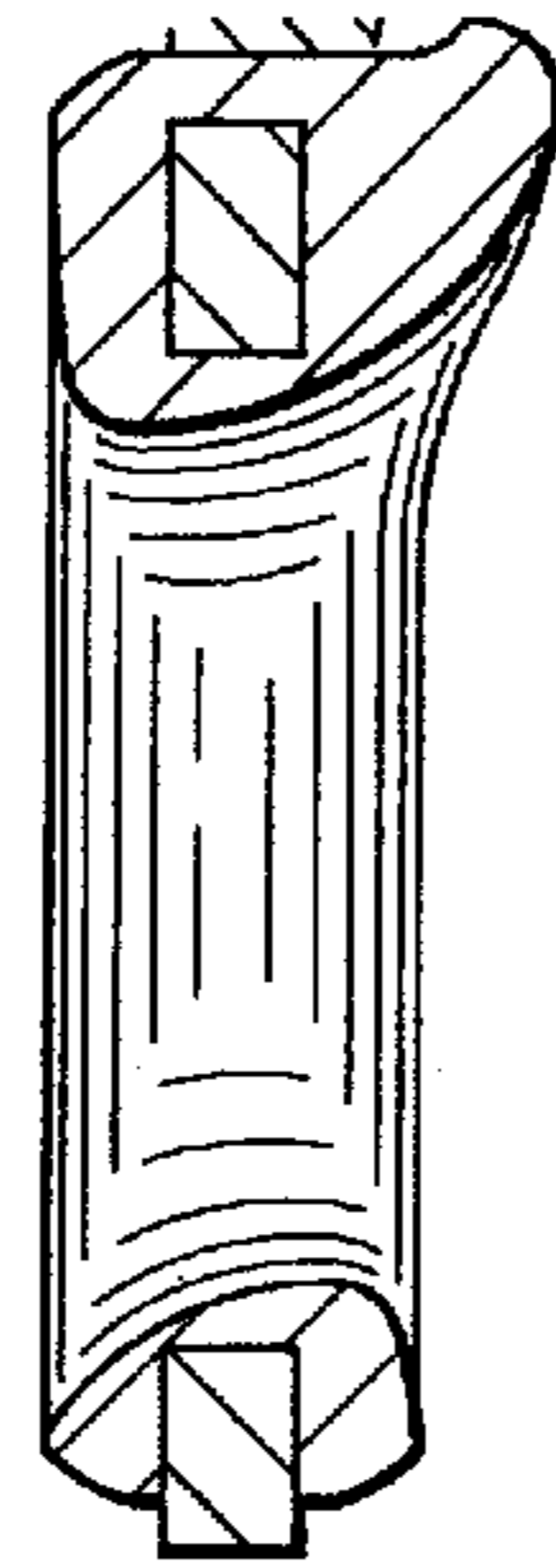

Fig.12

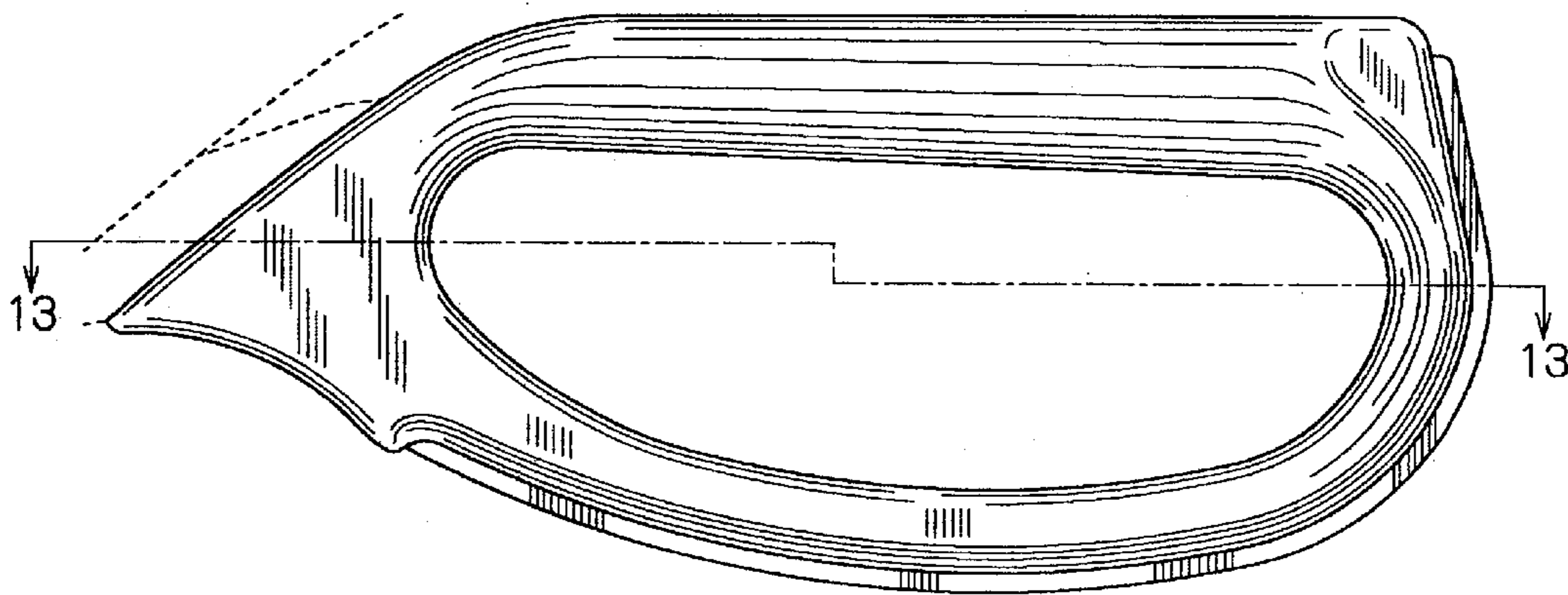

Fig.13

