

US00D502028S

(12) **United States Design Patent**
Ashby et al.

(10) **Patent No.:** **US D502,028 S**

(45) **Date of Patent:** **** Feb. 22, 2005**

(54) **TABLE**

(75) **Inventors:** **Kent Ashby**, Logan, UT (US); **David C. Winter**, Layton, UT (US); **S. Curtis Nye**, Clinton, UT (US); **Robert A. Astle**, Farmington, UT (US)

(73) **Assignee:** **Lifetime Products, Inc.**, Clearfield, UT (US)

(**) **Term:** **14 Years**

(21) **Appl. No.:** **29/179,374**

(22) **Filed:** **Apr. 9, 2003**

(51) **LOC (7) Cl.** **06-03**

(52) **U.S. Cl.** **D6/480; D6/422**

(58) **Field of Search** D6/480-489, 495, D6/499, 422, 426; 108/150, 153.1, 155, 156, 157.1, 161, 40; 248/188, 188.1, 188.8; 312/208.1

(56) **References Cited**

U.S. PATENT DOCUMENTS

D376,712 S * 12/1996 Mezger D6/487

D444,001 S * 6/2001 Minami D6/422
D448,216 S * 9/2001 Kolberg D6/484
D455,918 S * 4/2002 Moore D6/487
D465,359 S * 11/2002 Kolberg D6/495

* cited by examiner

Primary Examiner—Janice E. Seeger

(74) *Attorney, Agent, or Firm*—Workman Nydegger

(57) **CLAIM**

The ornamental design for a table, as shown and described.

DESCRIPTION

FIG. 1 is a top perspective view of an embodiment of a table; FIG. 2 is a bottom perspective view of the table shown in FIG. 1;

FIG. 3 is a top view of the table shown in FIG. 1;

FIG. 4 is a bottom view of the table shown in FIG. 1;

FIG. 5 is a front view of the table shown in FIG. 1;

FIG. 6 is a right side view of the table shown in FIG. 1;

FIG. 7 is a back view of the table shown in FIG. 1; and,

FIG. 8 is a left side view of the table shown in FIG. 1.

The broken lines are for illustrative purposes only and form no part of the claimed design.

1 Claim, 5 Drawing Sheets

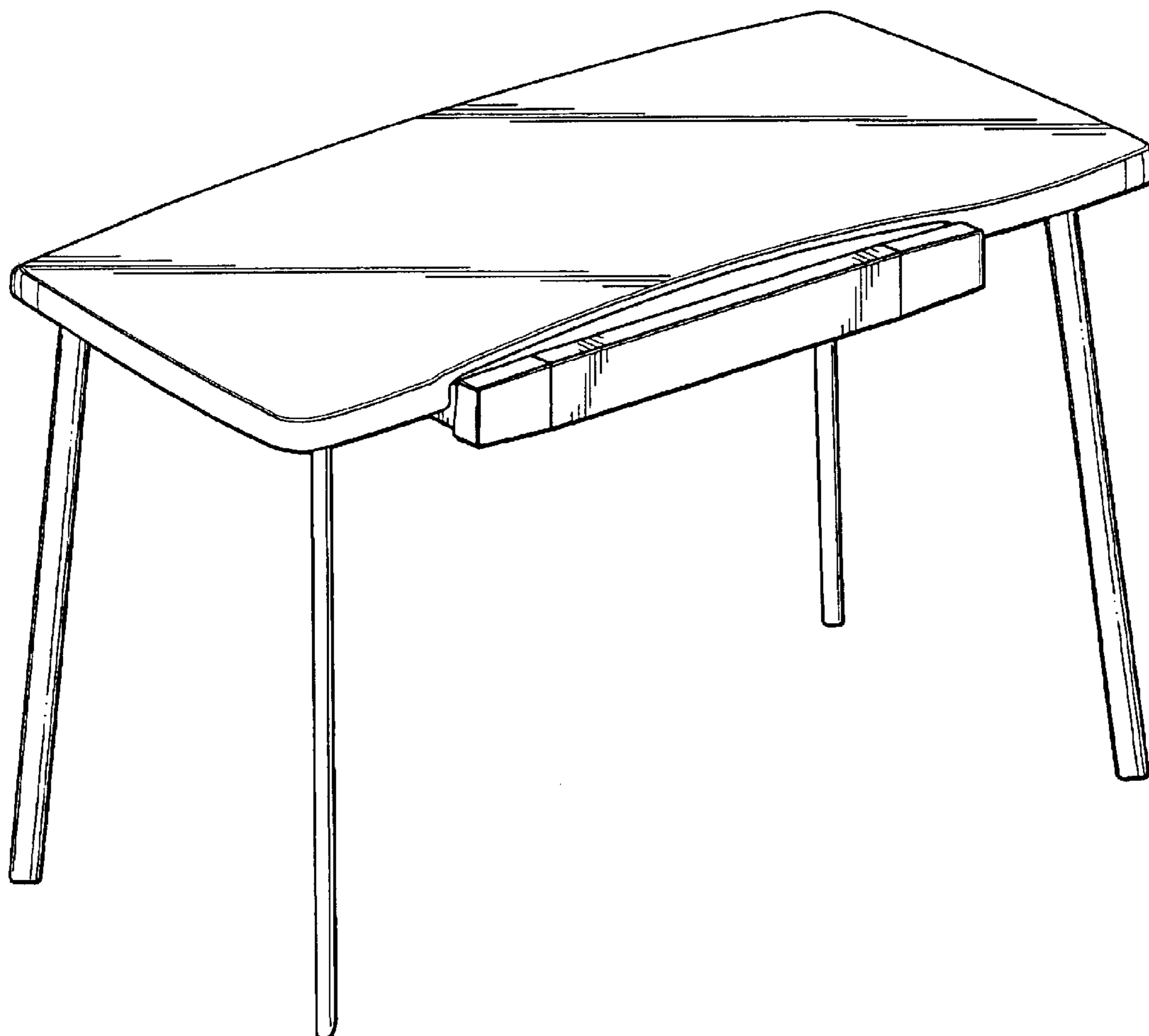

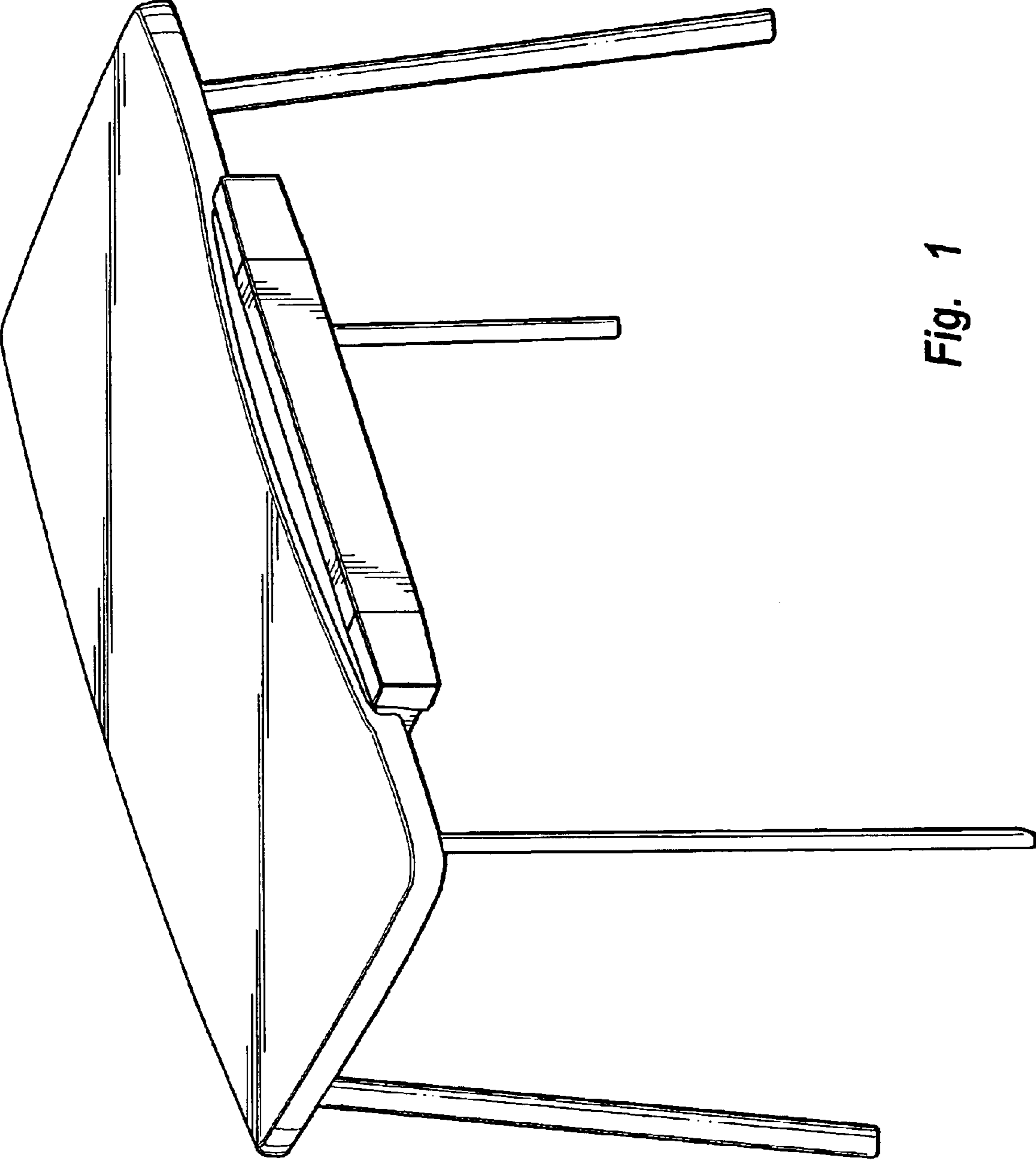

Fig. 1

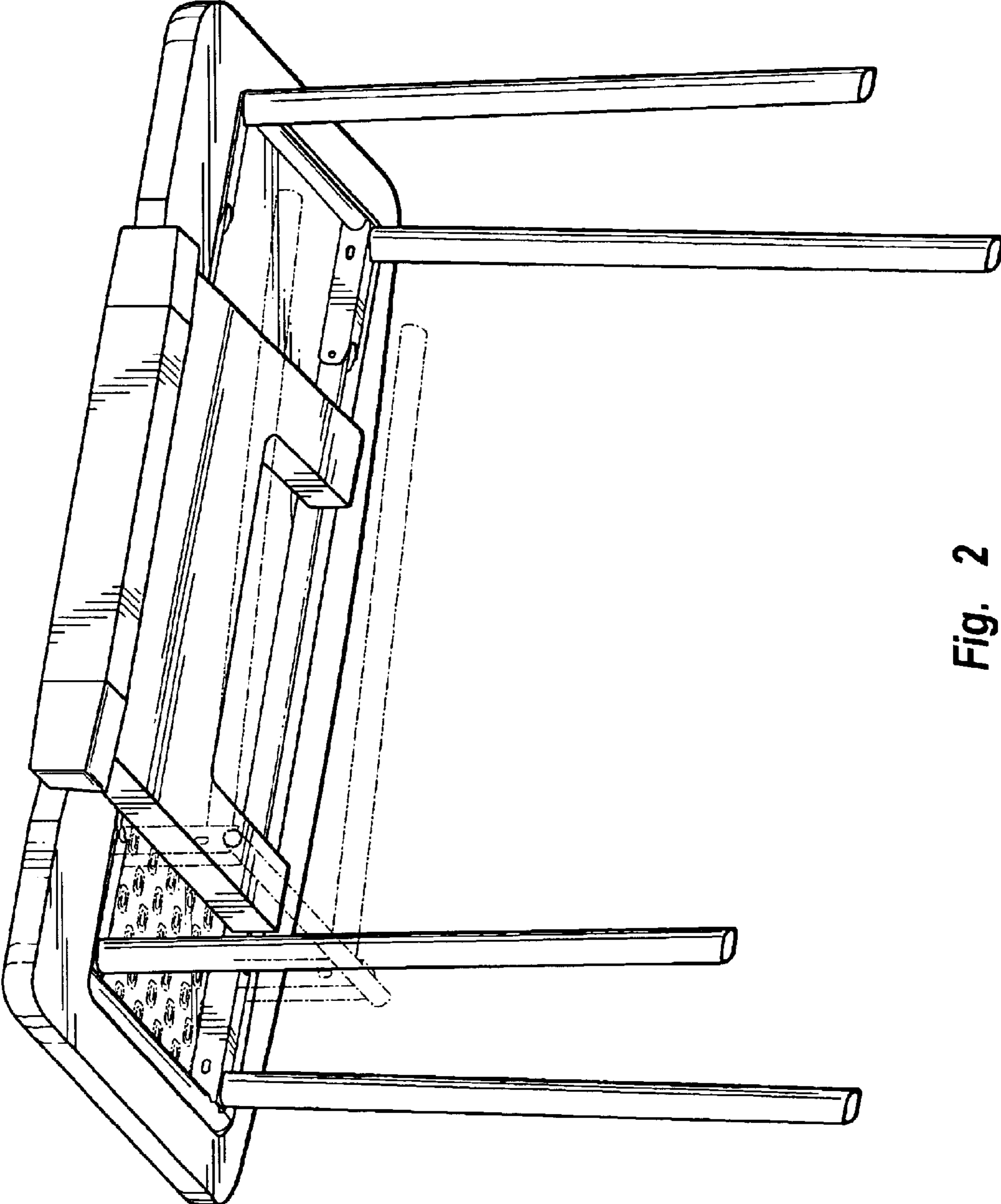

Fig. 2

Fig. 3

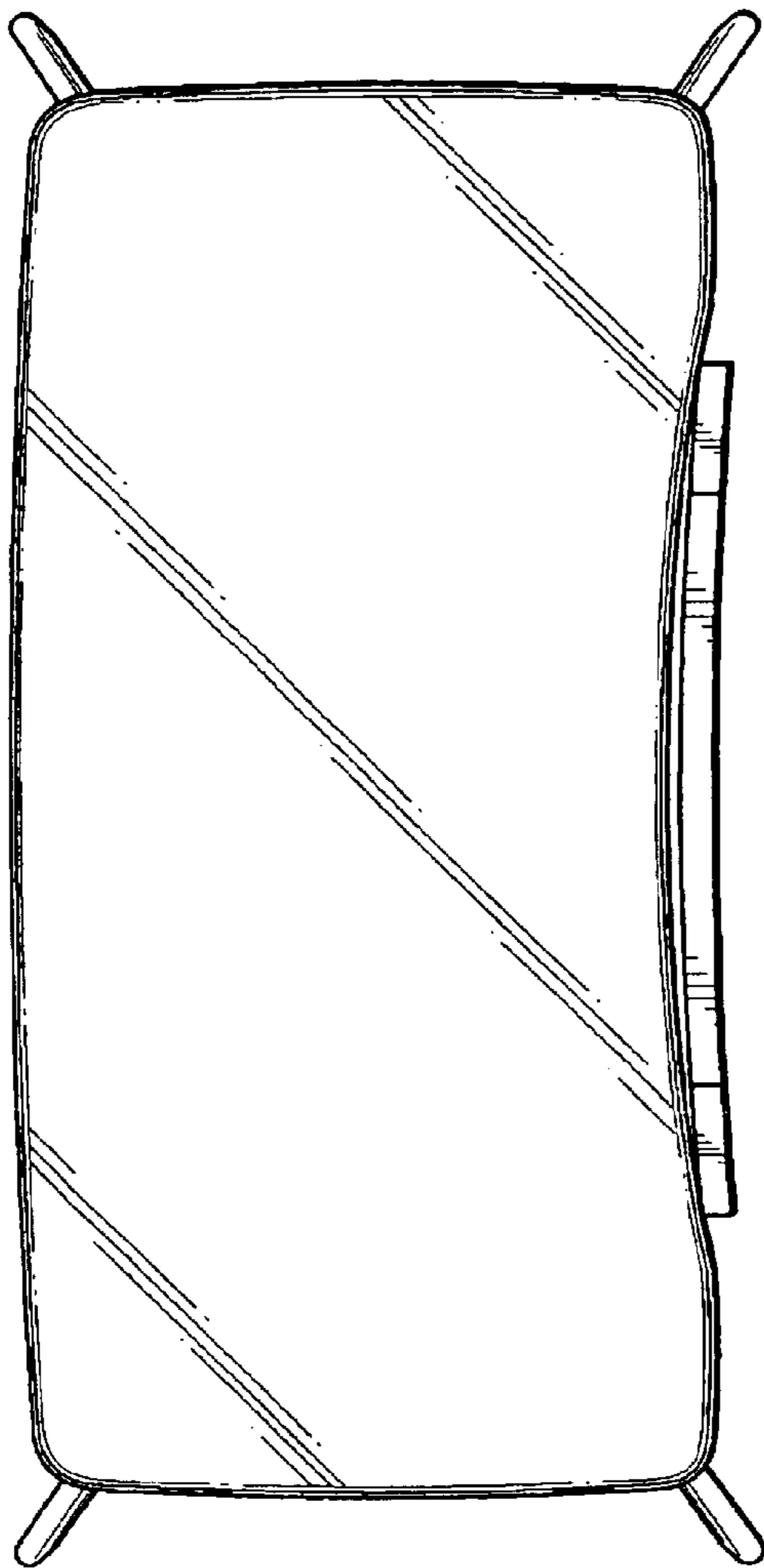
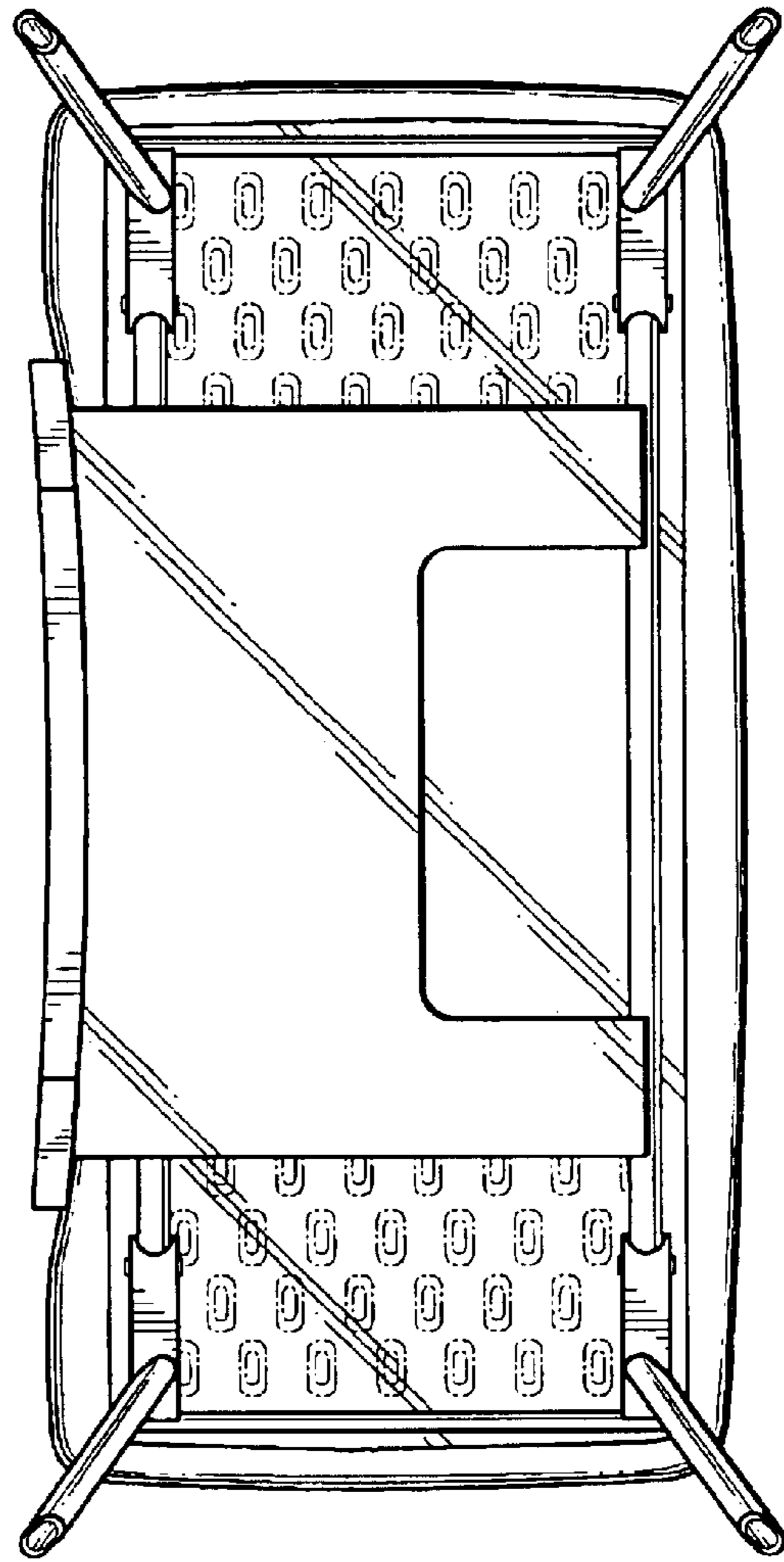

Fig. 4



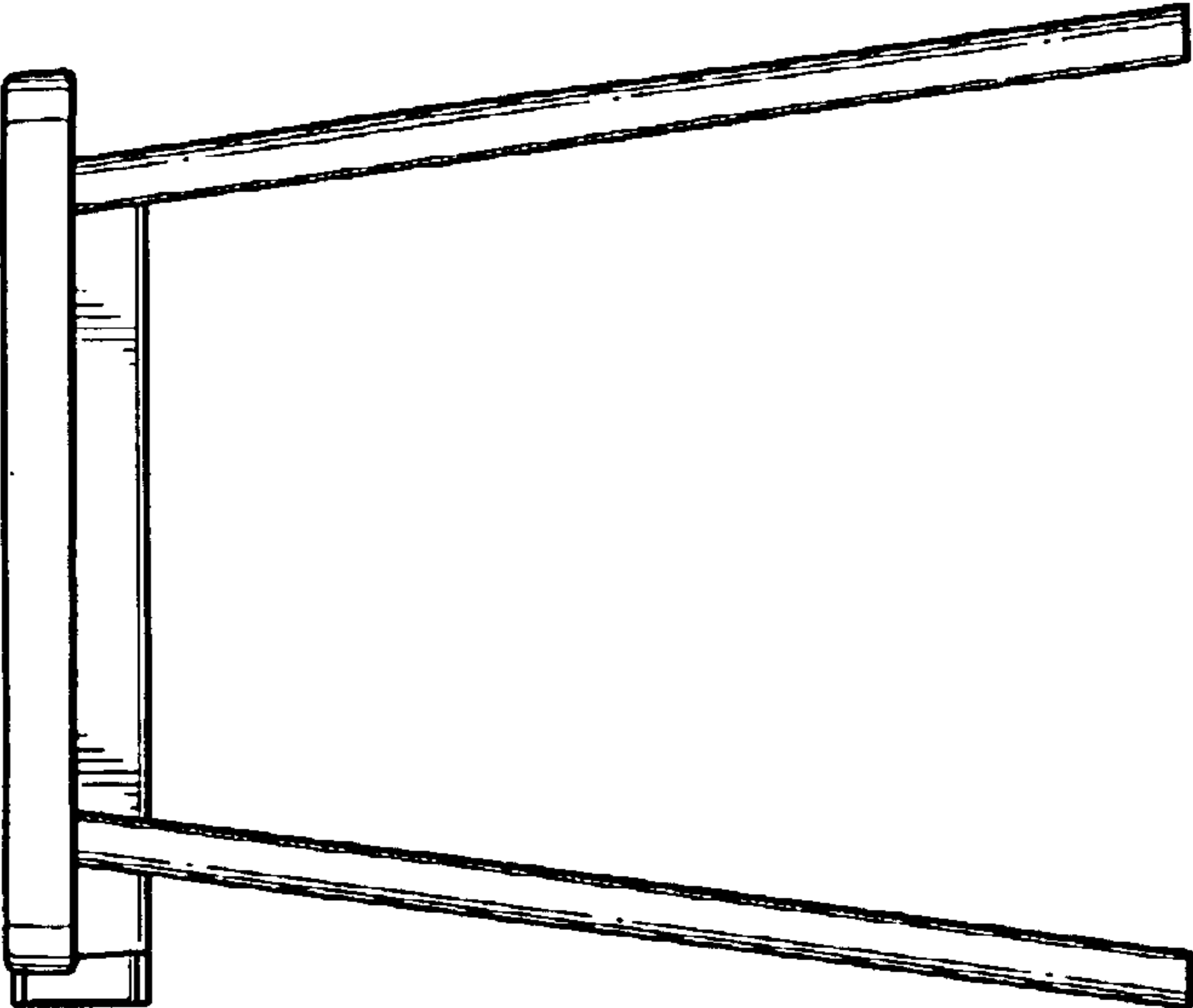

Fig. 6

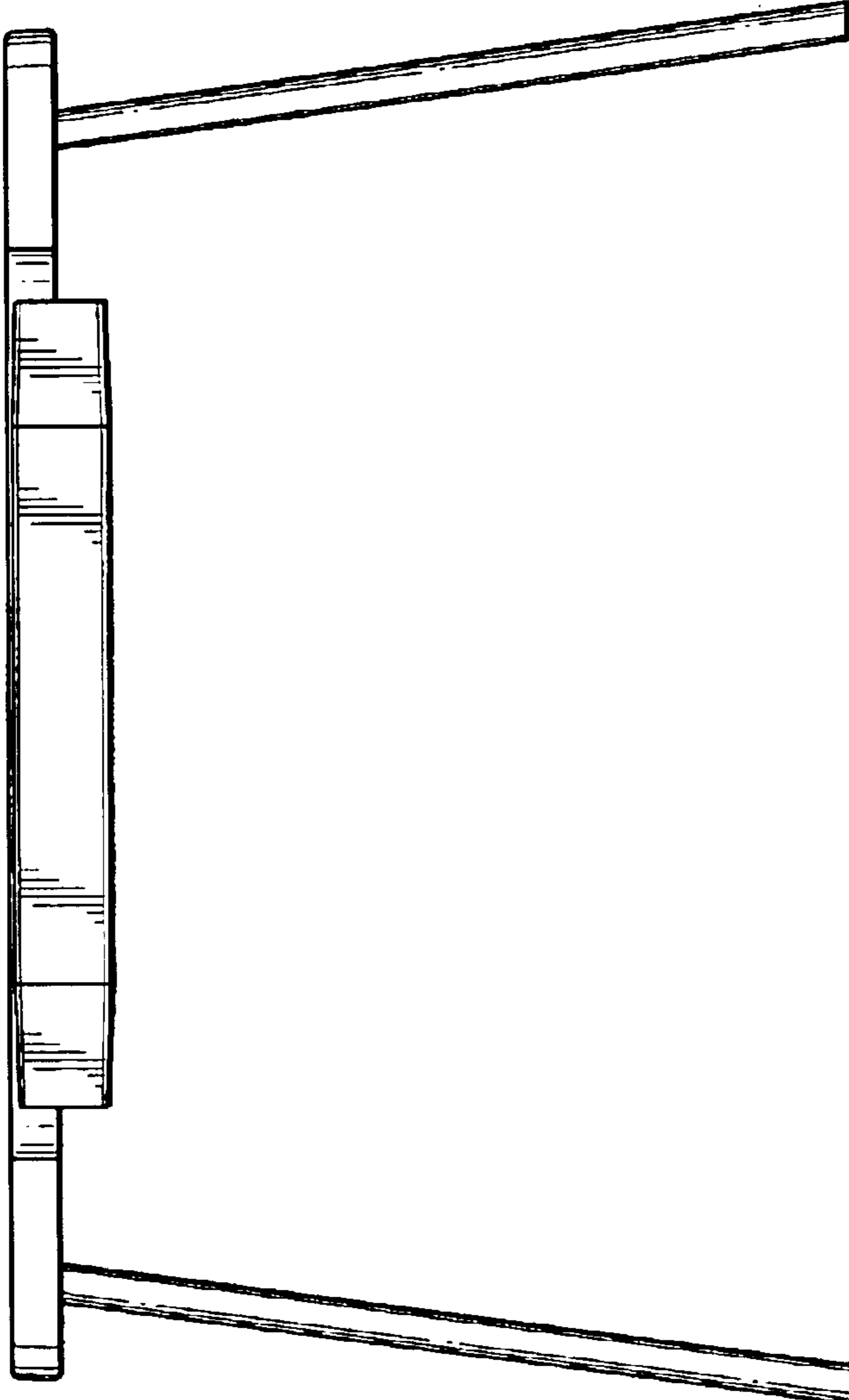

Fig. 5

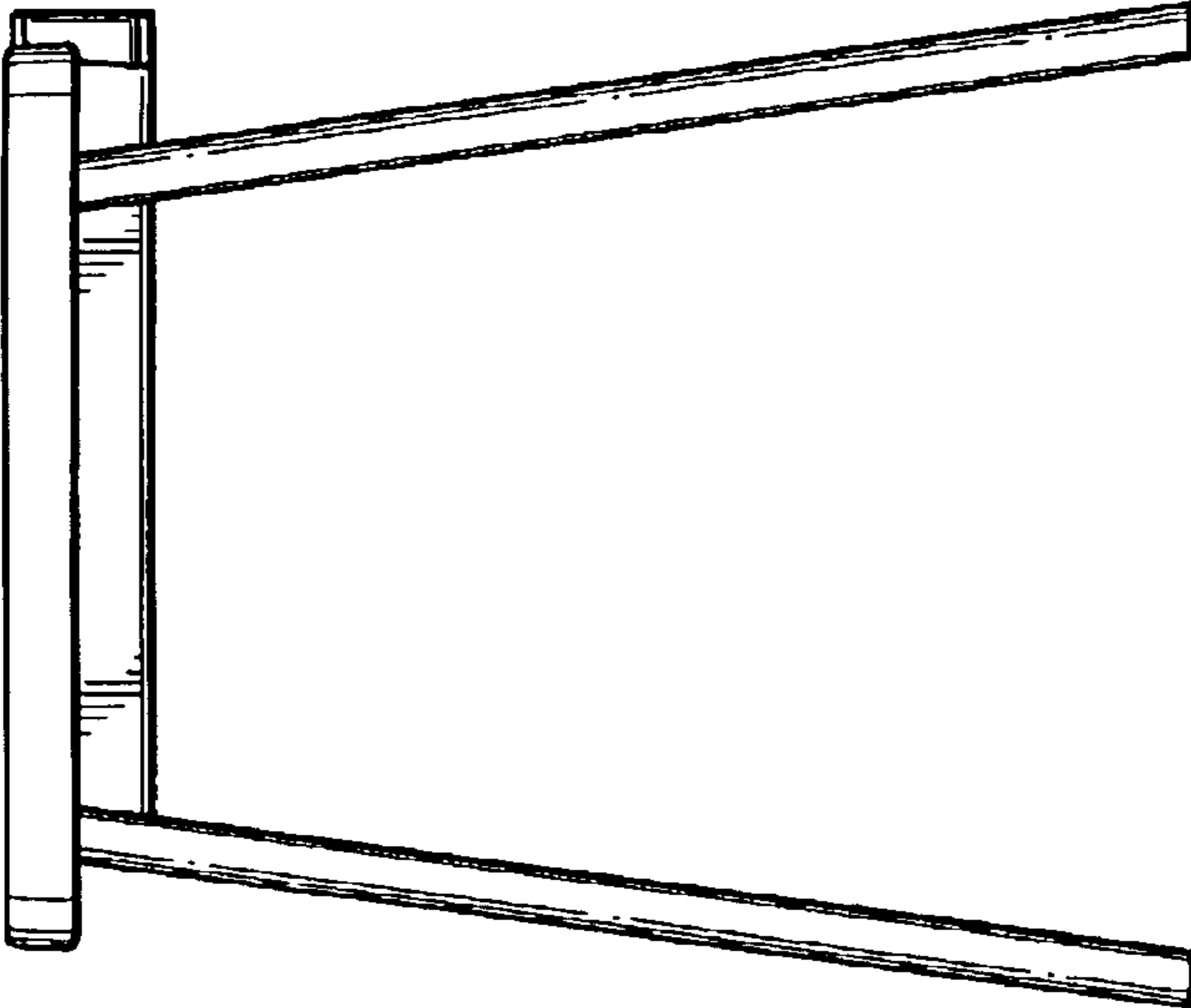

Fig. 8

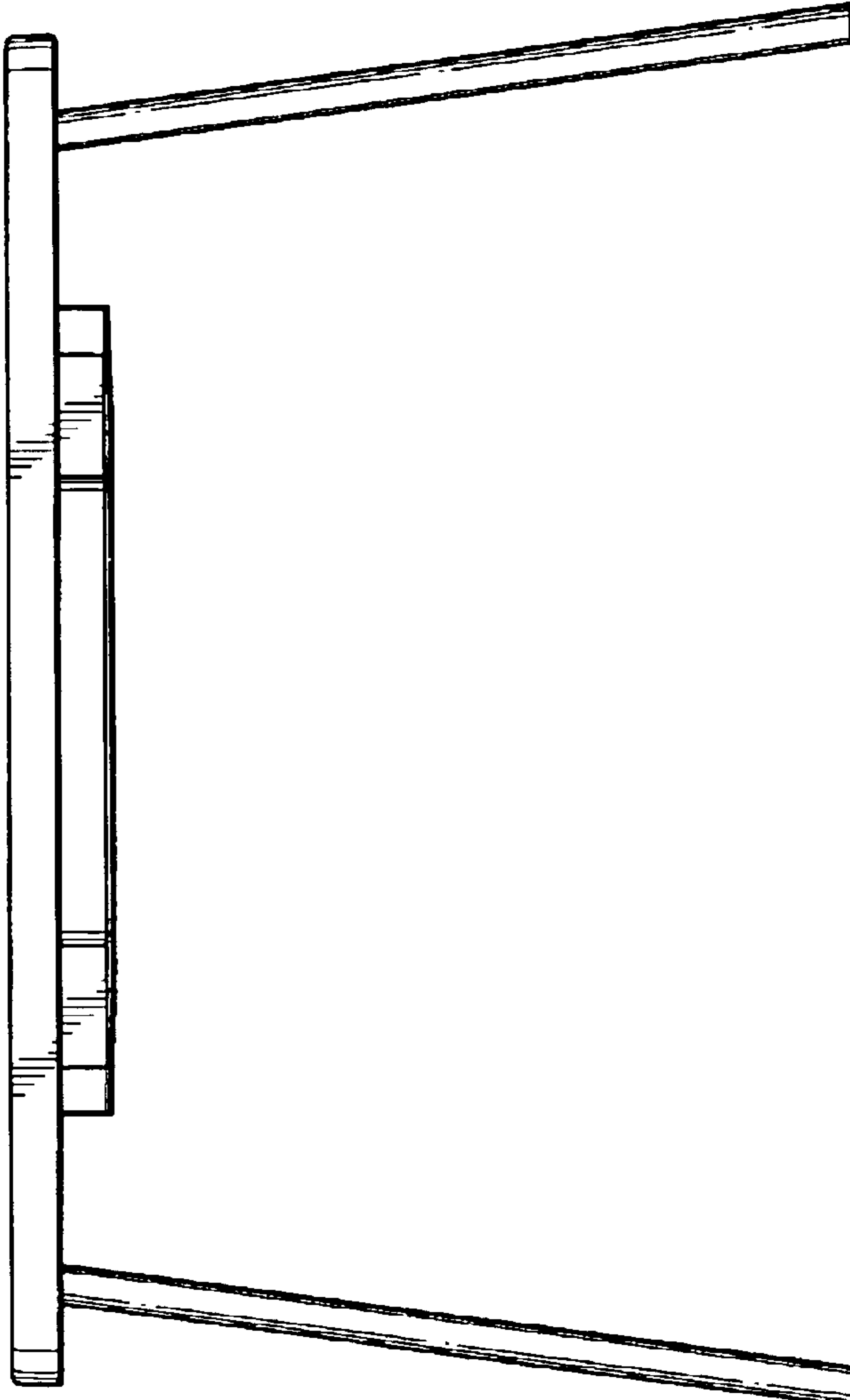

Fig. 7