

US00D502023S

(12) **United States Design Patent**
Anderson et al.

(10) **Patent No.:** **US D502,023 S**

(45) **Date of Patent:** **** Feb. 22, 2005**

(54) **SPORT BENCH**

D460,886 S * 7/2002 Hashizume et al. D6/509
D485,450 S * 1/2004 Smith D6/432

(75) Inventors: **Torrence Anderson**, Overland Park, KS (US); **Brian Moon**, DeKalb, IL (US)

* cited by examiner

(73) Assignee: **Suncast Corporation**, Batavia, IL (US)

Primary Examiner—Cathron Brooks

(74) *Attorney, Agent, or Firm*—McHale & Slavin, P.A.

(**) Term: **14 Years**

(57) **CLAIM**

(21) Appl. No.: **29/195,707**

The ornamental design for a sport bench, as shown and described.

(22) Filed: **Dec. 15, 2003**

DESCRIPTION

(51) **LOC (7) Cl.** **06-04**

FIG. 1 is a perspective view of the sport bench, of the instant invention;

(52) **U.S. Cl.** **D6/440**; D6/336; D6/448

FIG. 2 is a left side view thereof;

(58) **Field of Search** D6/432-448, 336, D6/349; D3/272; 312/204, 213, 249.1, 249.8, 108

FIG. 3 is a right side view thereof;

FIG. 4 is a front plane view thereof;

FIG. 5 is a rear plane view thereof;

FIG. 6 is a top view thereof; and,

FIG. 7 is a bottom view thereof.

(56) **References Cited**

U.S. PATENT DOCUMENTS

2,667,398 A * 1/1954 Claffin 312/213

1 Claim, 5 Drawing Sheets

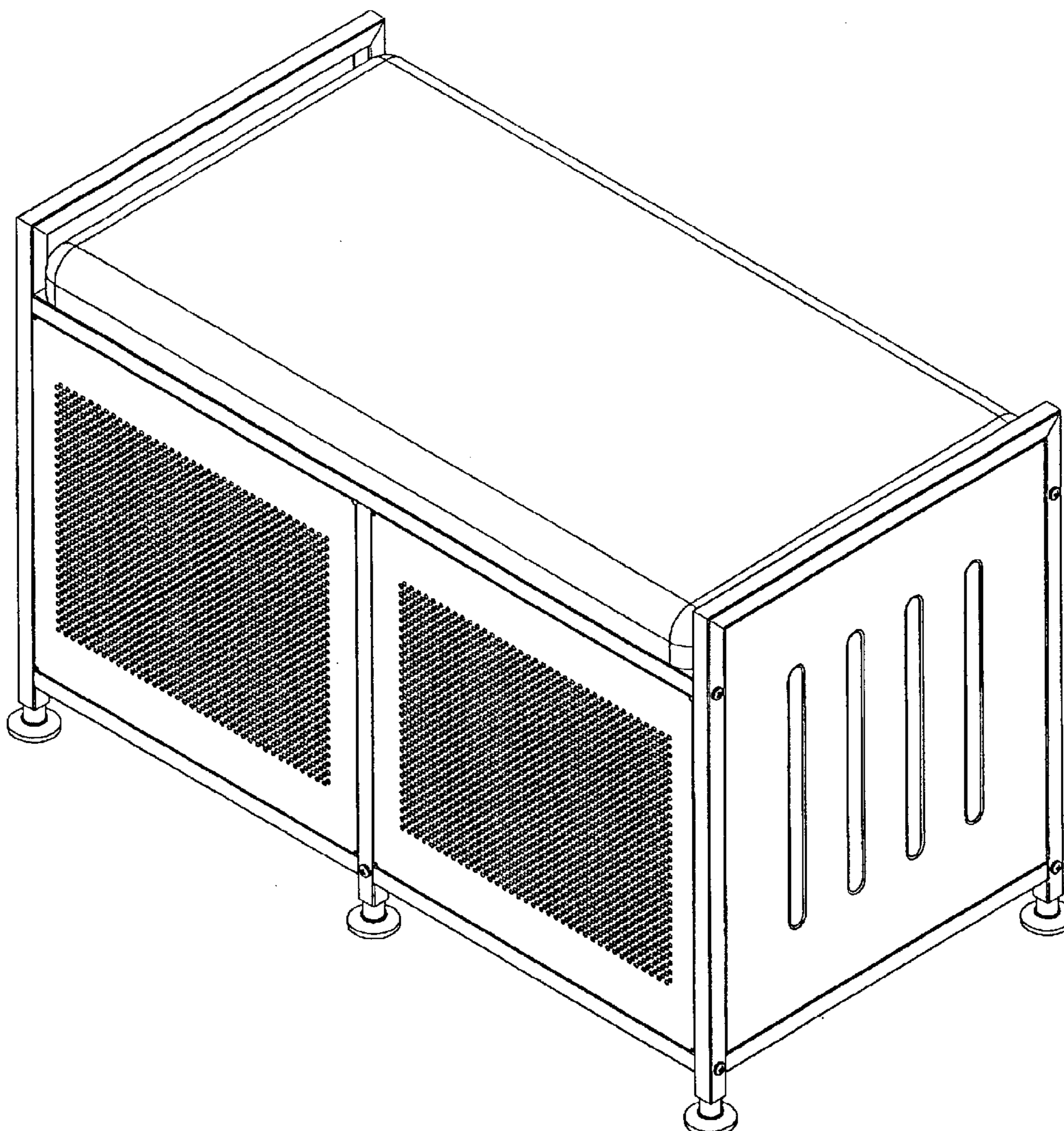

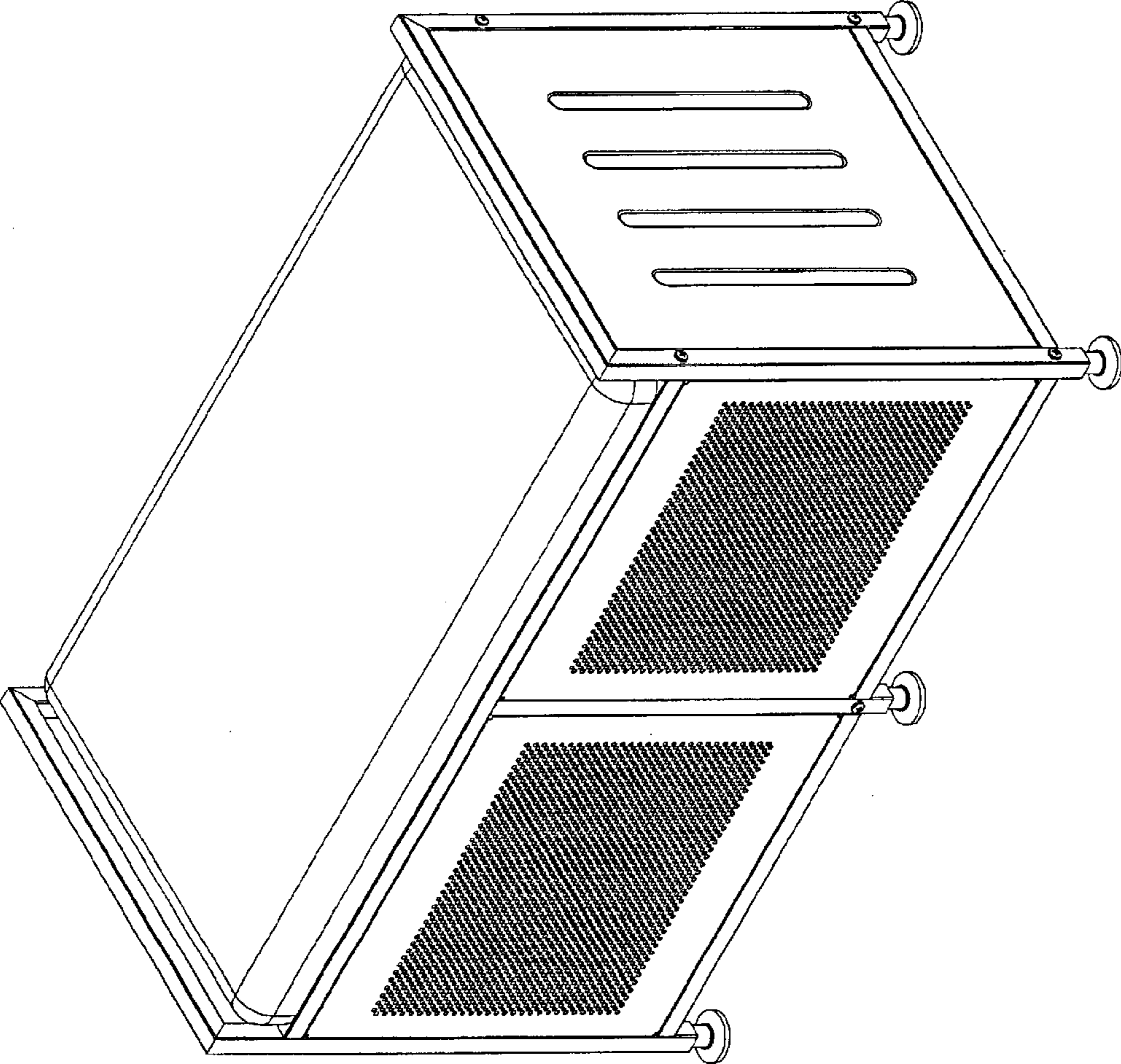

FIGURE 1

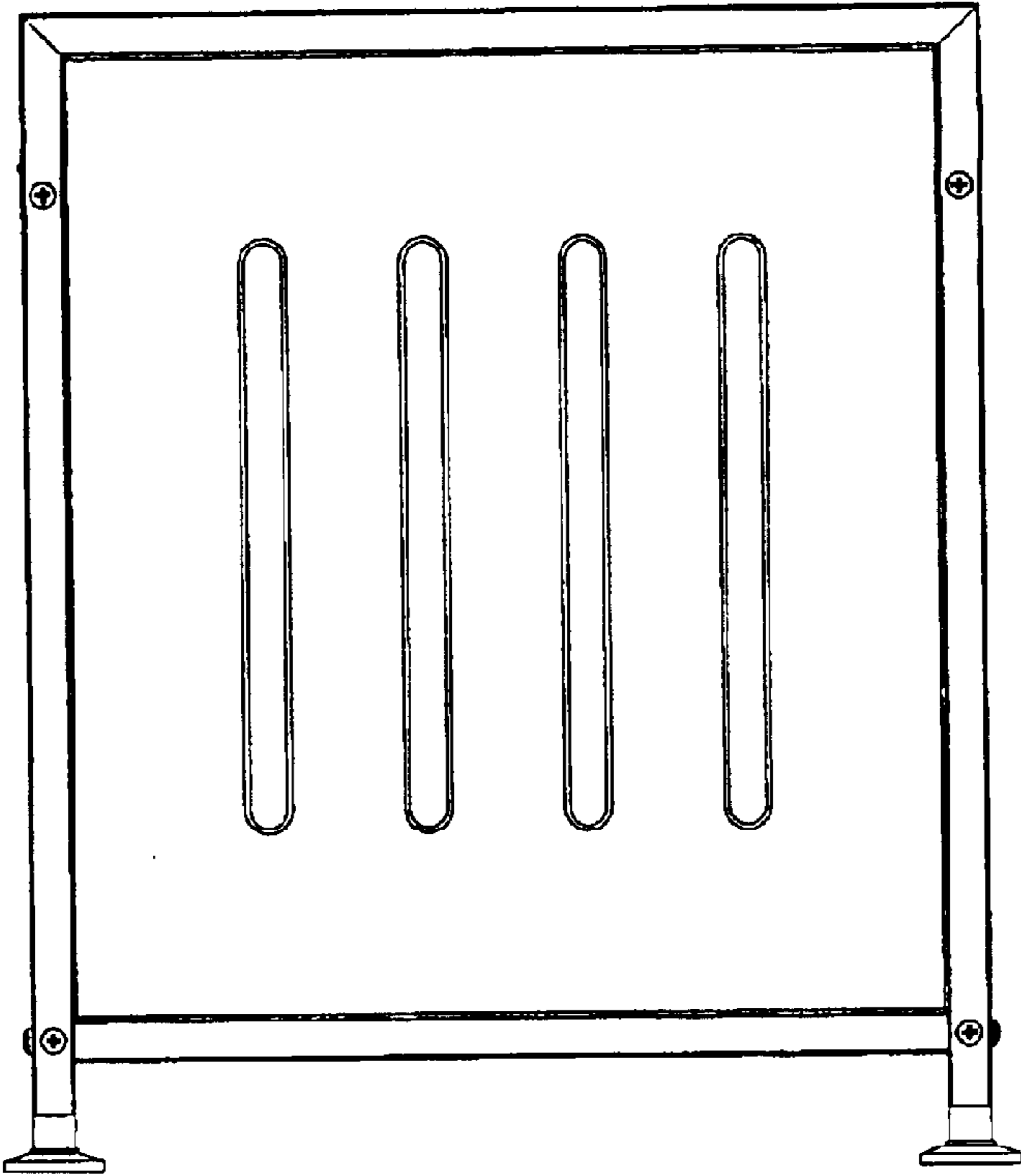

FIGURE 2

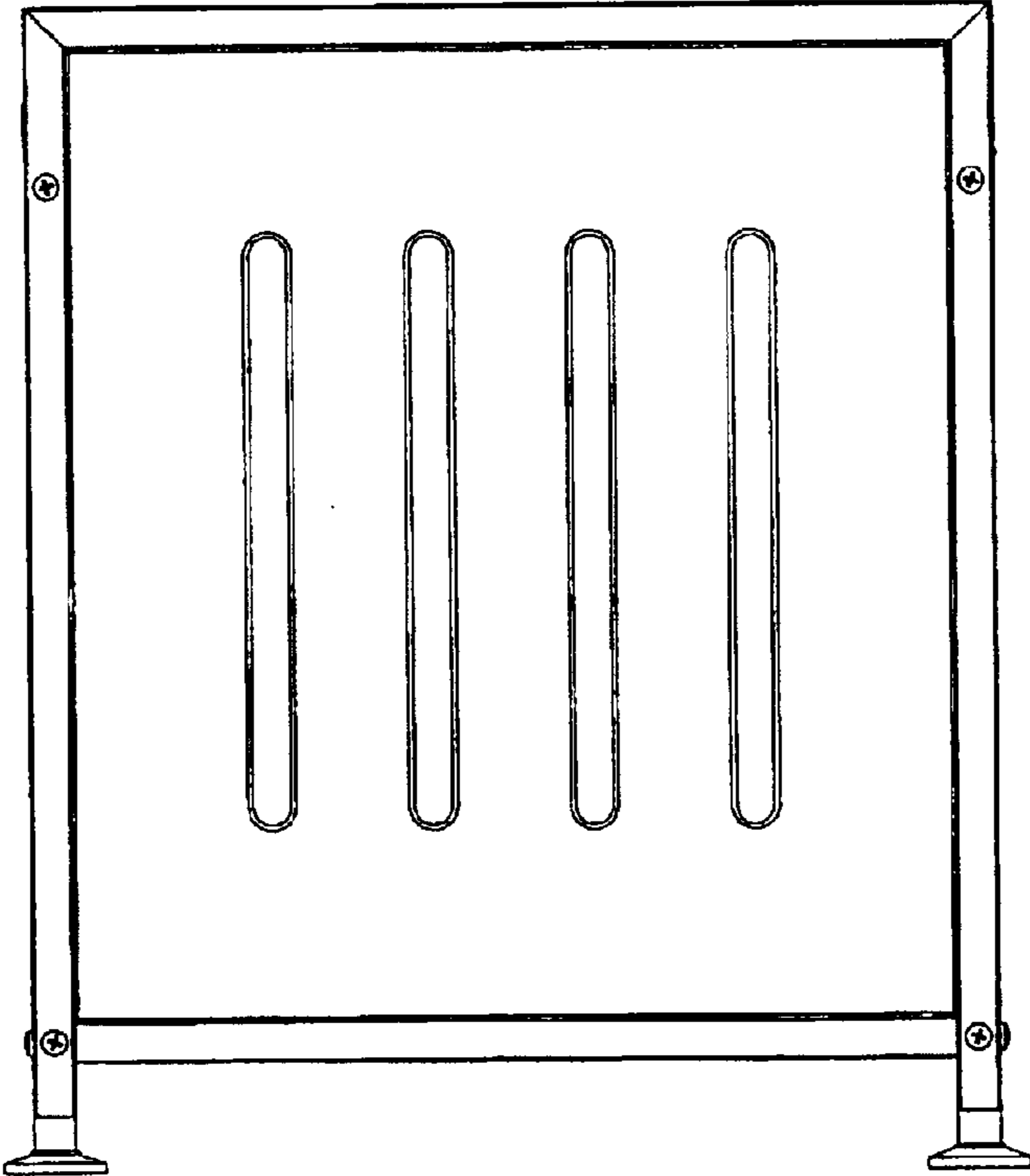

FIGURE 3

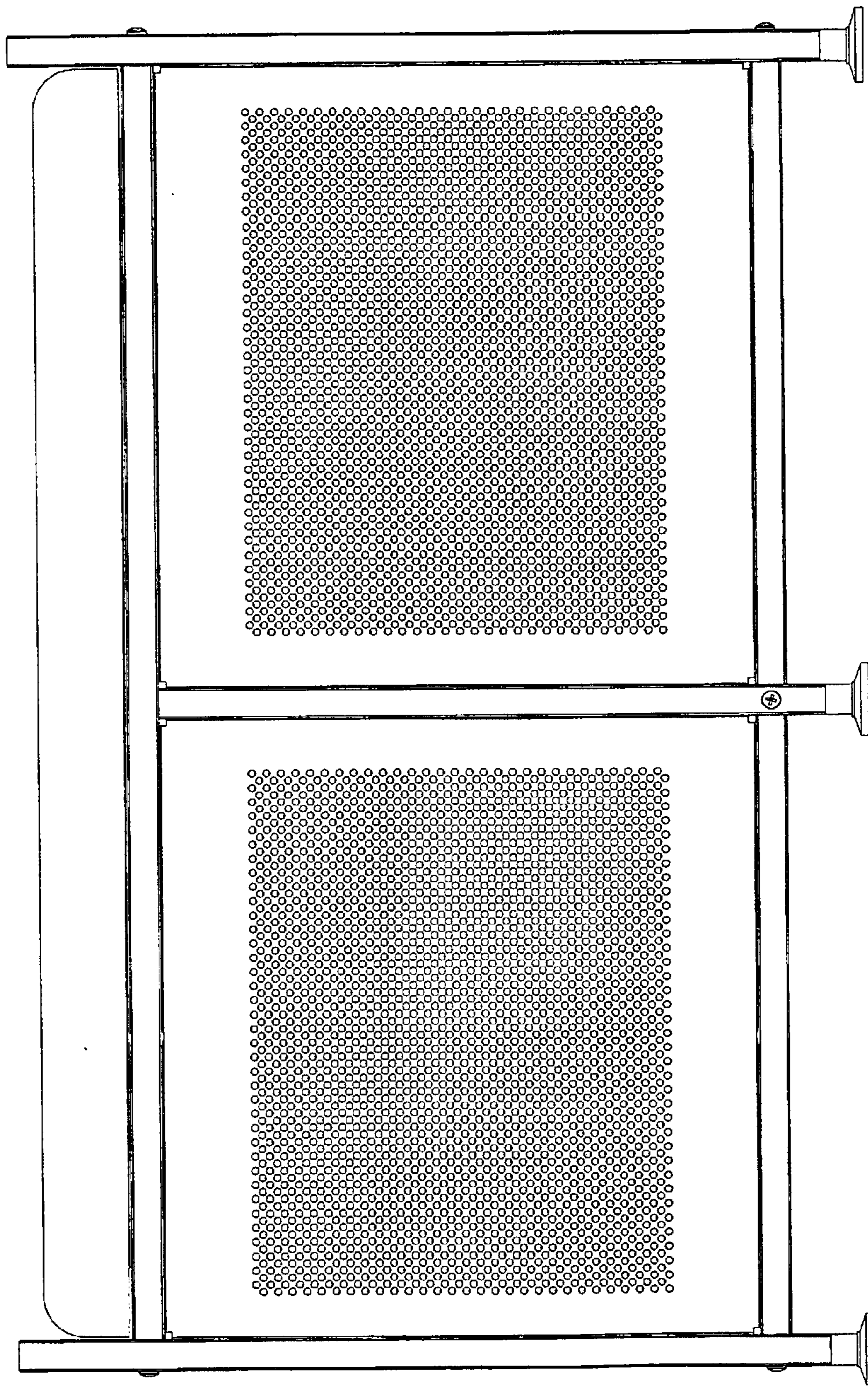

FIGURE 4

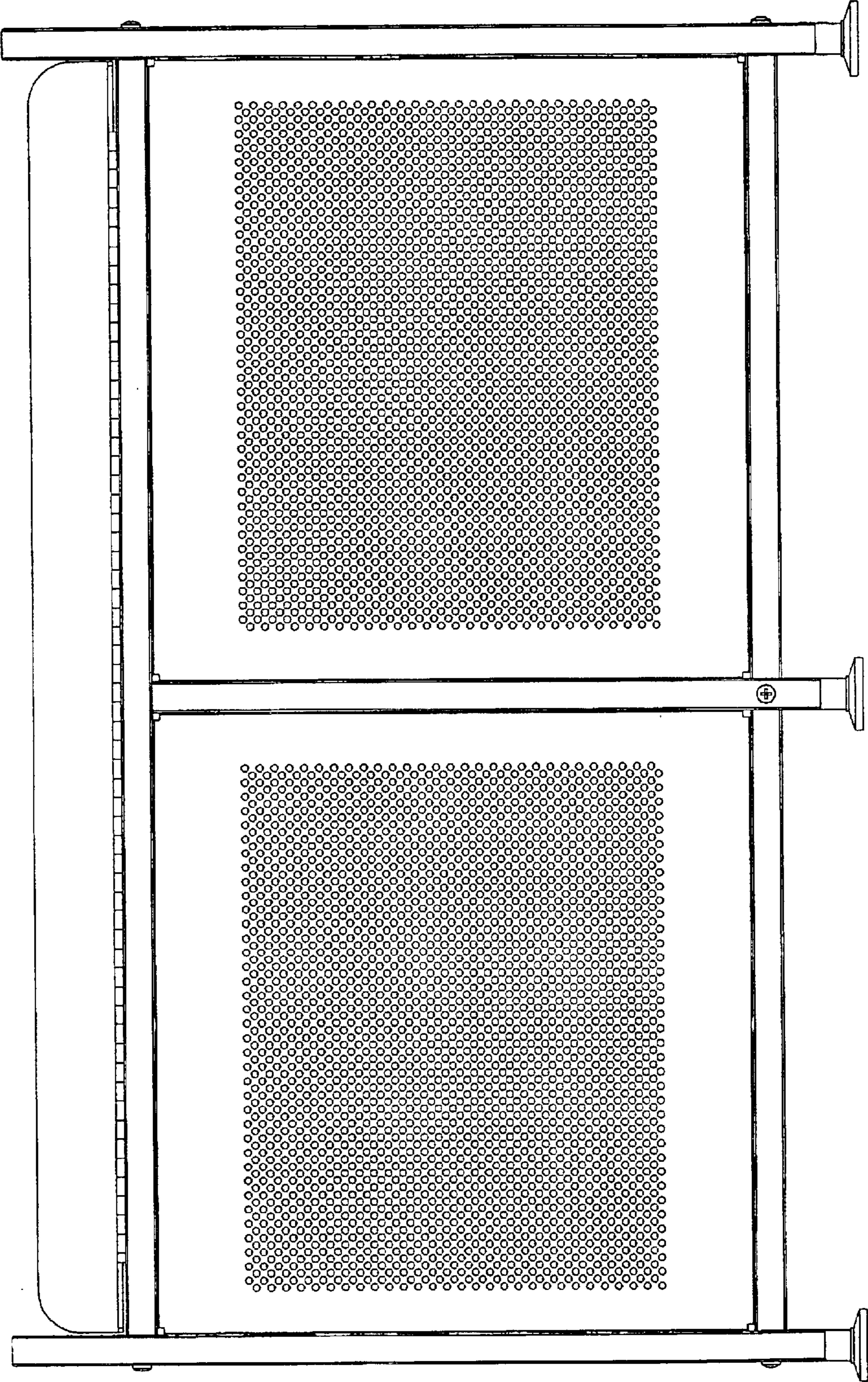

FIGURE 5

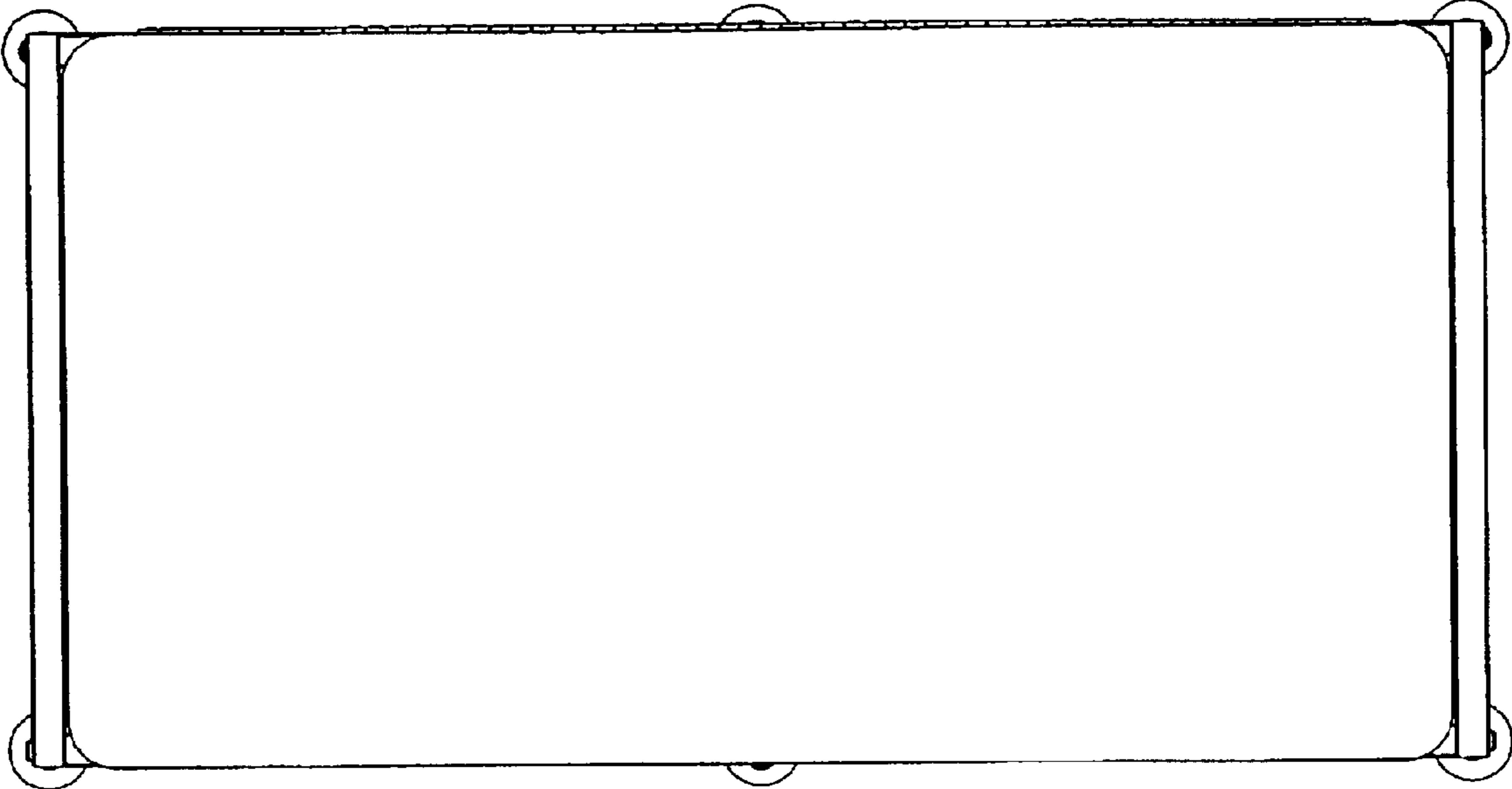

FIGURE 6

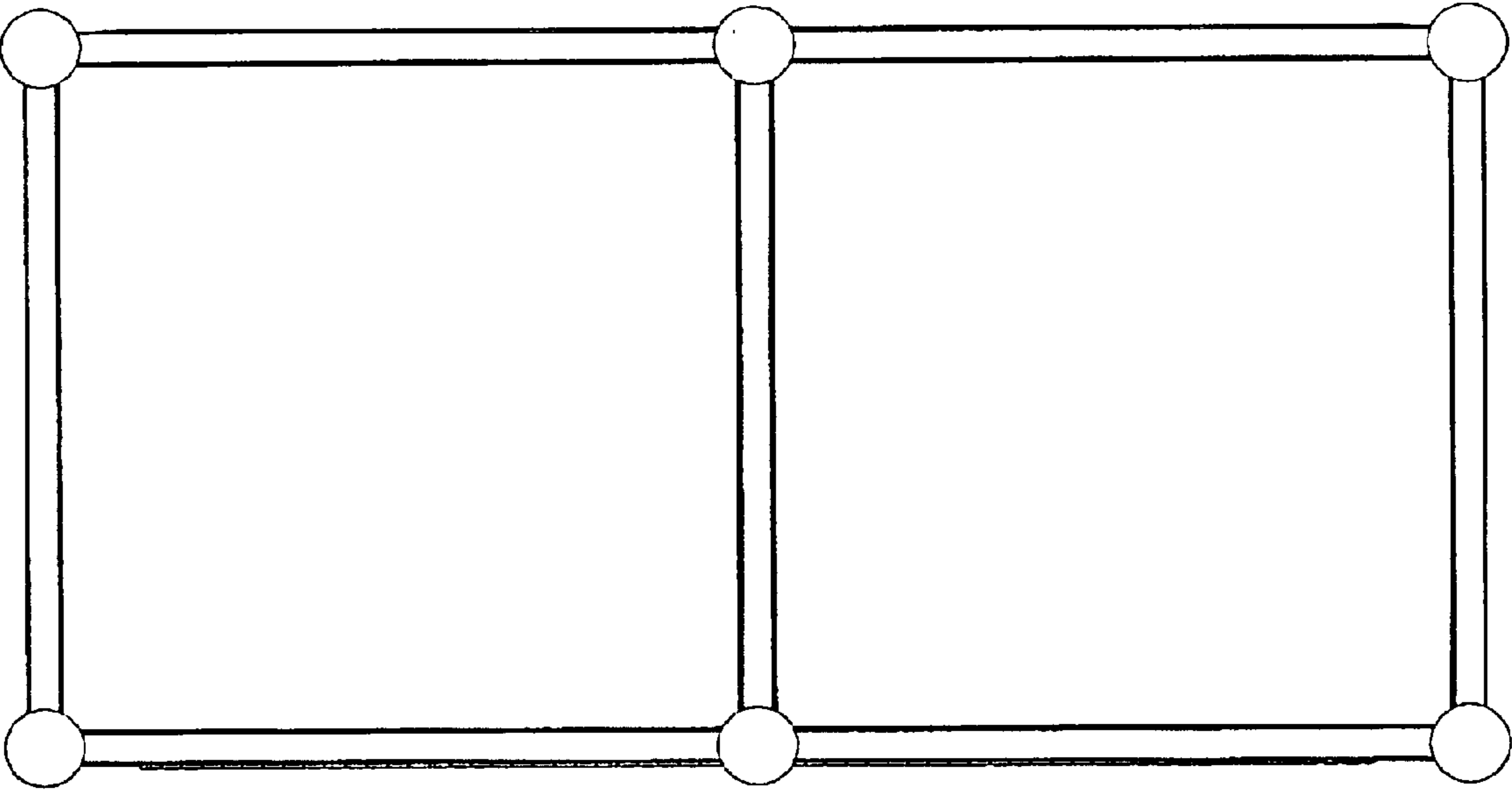

FIGURE 7