



US00D501991S

(12) **United States Design Patent** (10) **Patent No.:** **US D501,991 S**
Cook et al. (45) **Date of Patent:** **** Feb. 22, 2005**

(54) **RIGID HOLSTER**

(75) Inventors: **Clifton L. Cook**, Boise, ID (US);
Thomas M. Gregory, Belgrade, MT
(US); **Robert A. Kincaid**, Bozeman,
MT (US); **Eric M. Yeates**, Boise, ID
(US)

(73) Assignee: **Blackhawk Industries Product Group
Unlimited LLC**, Norfolk, VA (US)

(**) Term: **14 Years**

(21) Appl. No.: **29/199,058**

(22) Filed: **Feb. 9, 2004**

(51) **LOC (7) Cl.** **03-01**

(52) **U.S. Cl.** **D3/222**

(58) **Field of Search** D3/222, 223; 224/191–193,
224/198, 238, 243, 911–912, 901.4

(56) **References Cited**

U.S. PATENT DOCUMENTS

4,542,841 A * 9/1985 Bianchi et al. 224/193
D311,277 S * 10/1990 Cupp D3/222
D327,367 S * 6/1992 Carrow et al. D3/222
D373,242 S * 9/1996 Beletsky D3/222
5,632,426 A * 5/1997 Beletsky et al. 224/243

D392,458 S * 3/1998 Batts D3/222

* cited by examiner

Primary Examiner—Catherine R. Oliver

(74) *Attorney, Agent, or Firm*—Bowman Green Hampton
& Kelly, PLLC

(57) **CLAIM**

The ornamental design for a rigid holster, as shown and
described.

DESCRIPTION

FIG. 1 is a front perspective view of a rigid holster showing
our new design;

FIG. 2 is a rear perspective view of our rigid holster of FIG.
1;

FIG. 3 is a front side elevation view of our rigid holster of
FIG. 1, it being understood that the broken line disclosure of
a holster securing means is for illustrative purposes only and
forms no part of the claimed design;

FIG. 4 is a rear side elevation view of our rigid holster of
FIG. 3;

FIG. 5 is a right side elevation view of our rigid holster of
FIG. 1;

FIG. 6 is a left side elevation view of our rigid holster of
FIG. 1;

FIG. 7 is a top plan view of our rigid holster of FIG. 1; and,
FIG. 8 is a bottom plan view of our rigid holster of FIG. 1.

1 Claim, 3 Drawing Sheets

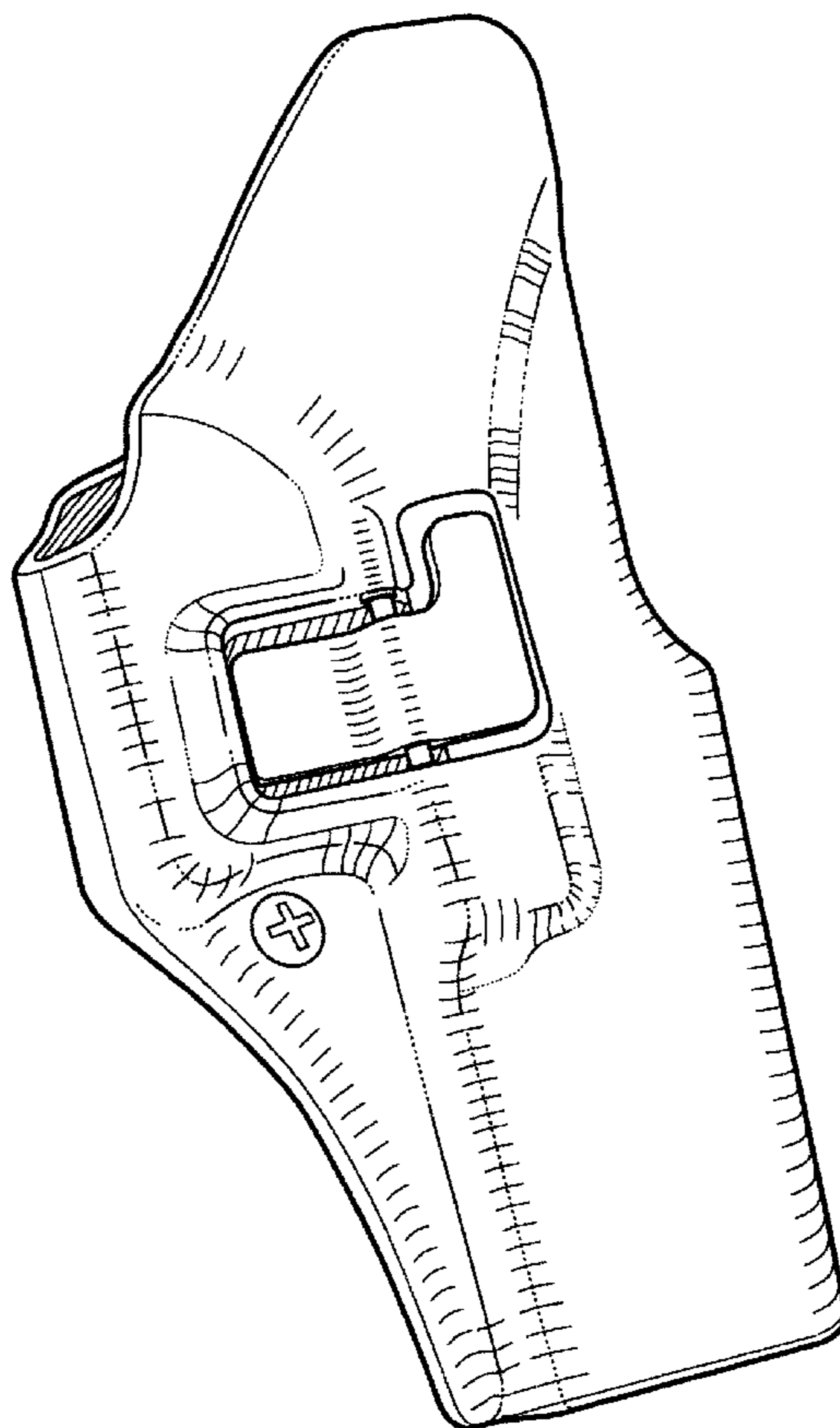

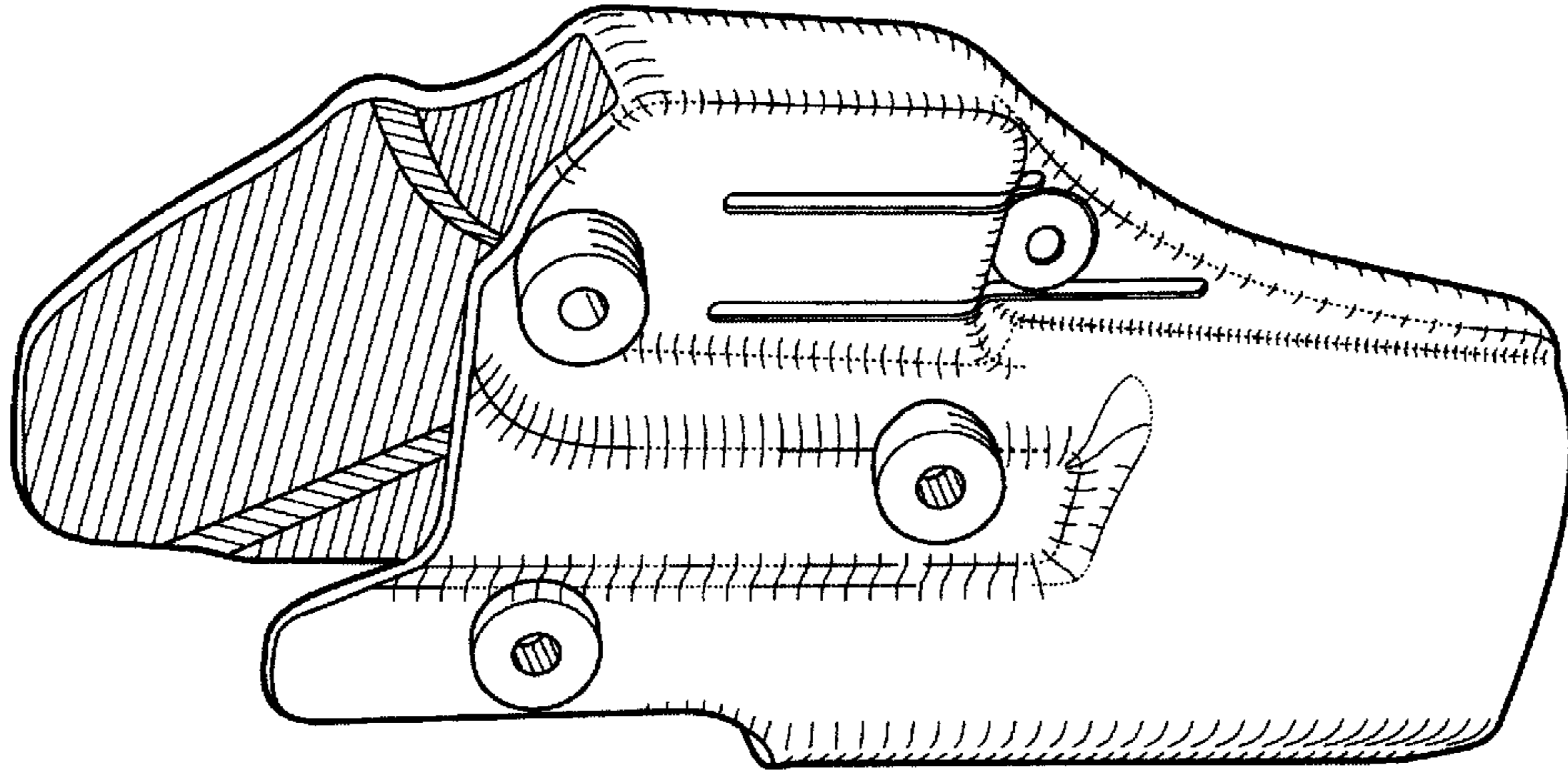

Fig. 2

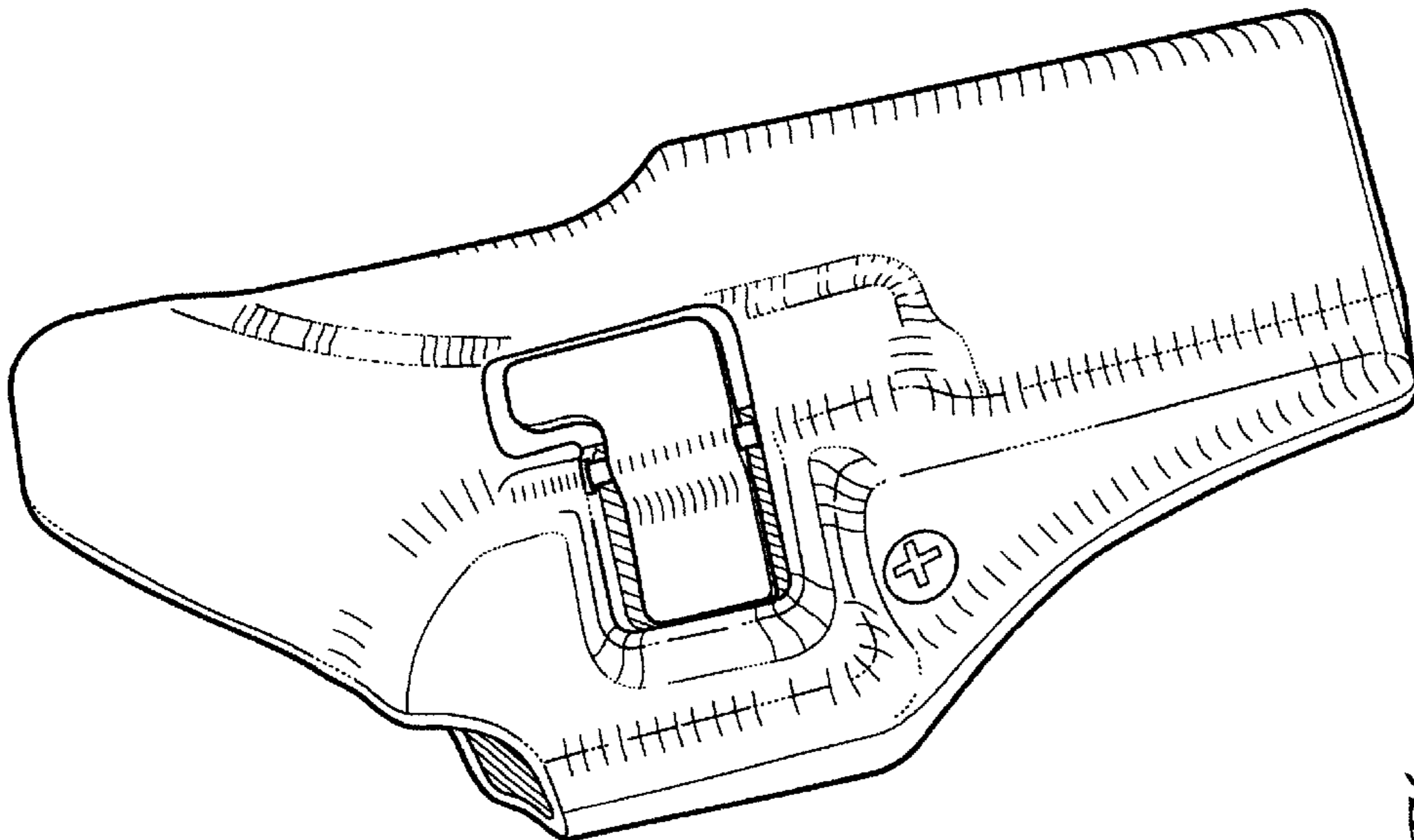

Fig. 1

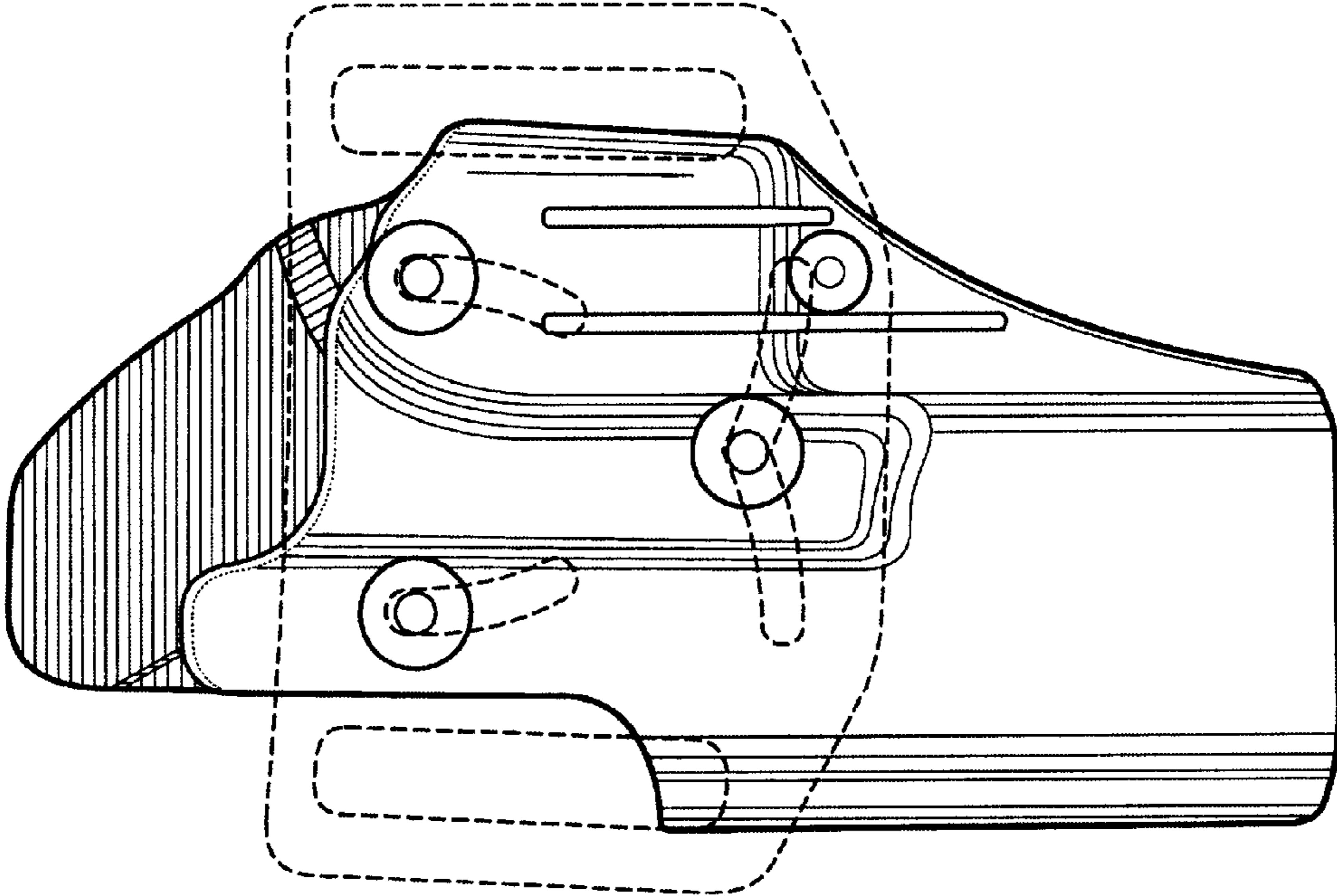

Fig. 3

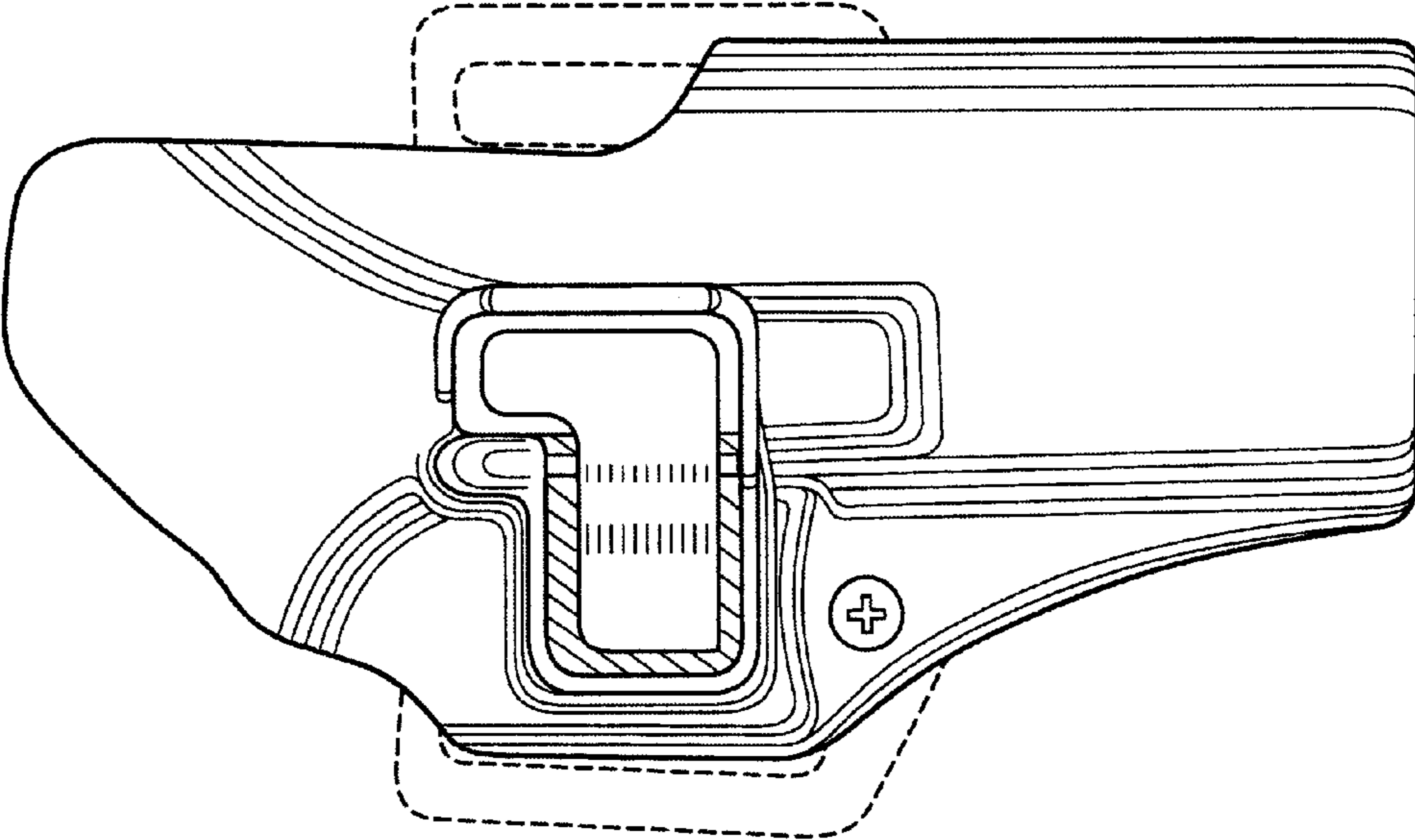

Fig. 4

Fig. 5

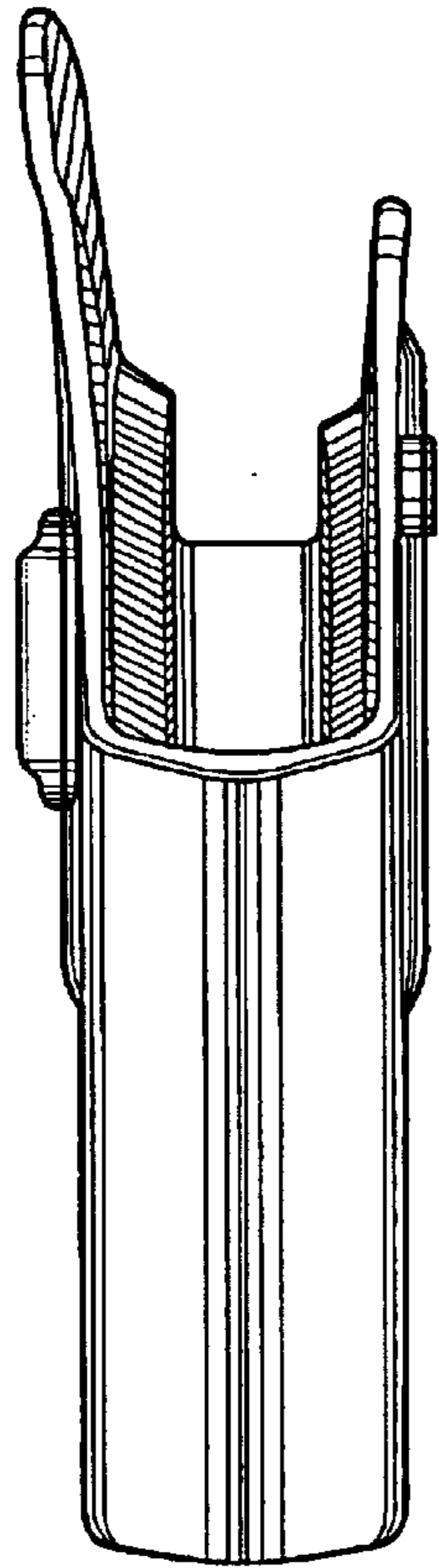

Fig. 6

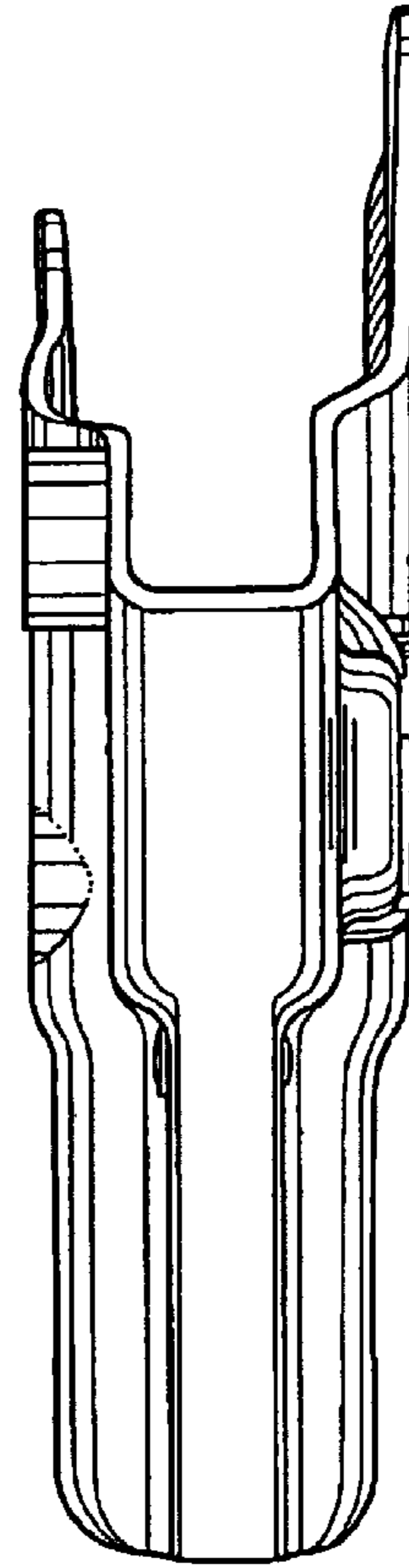

Fig. 7

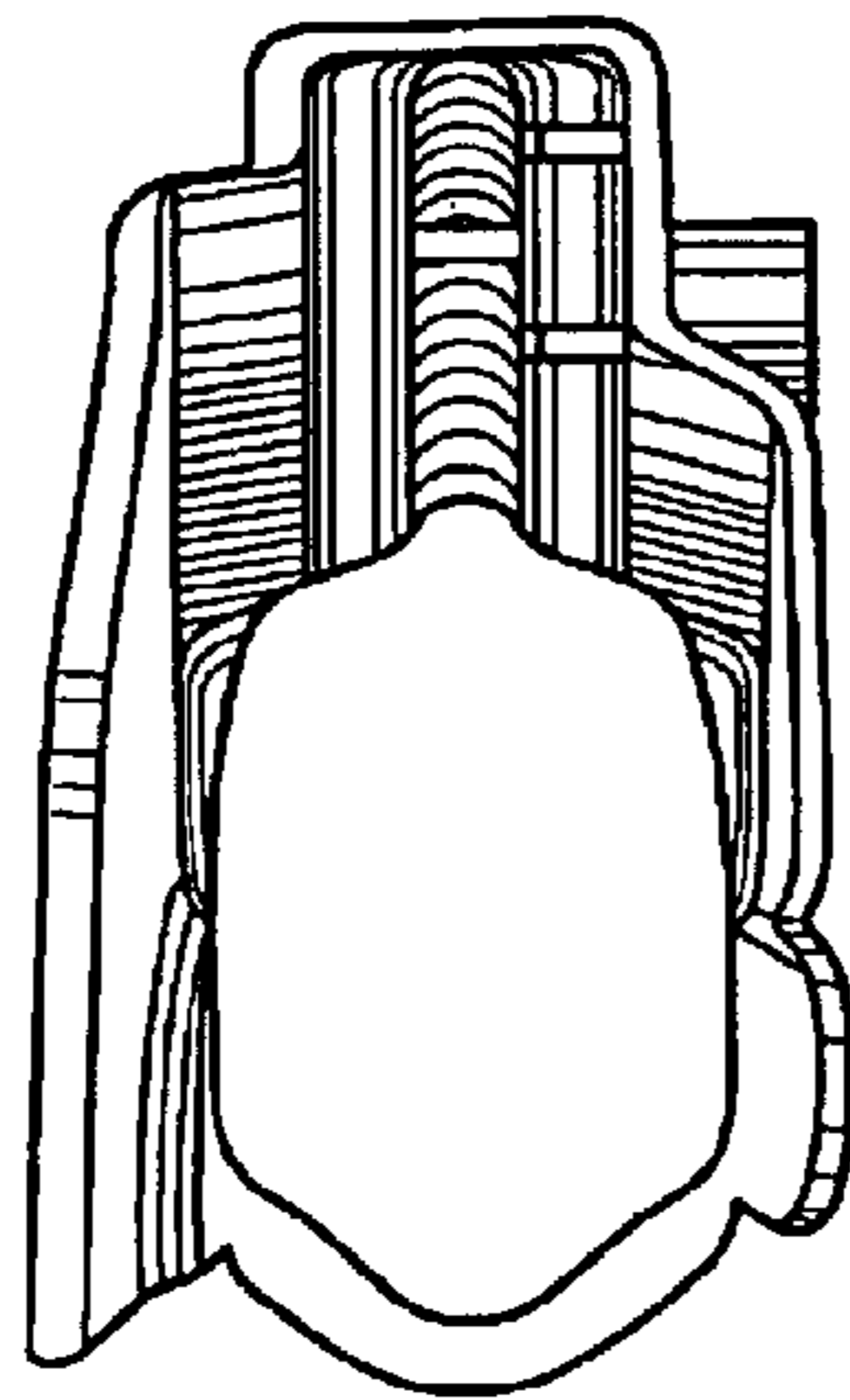

Fig. 8

