

US00D501889S

(12) **United States Design Patent**
Harris et al.

(10) **Patent No.:** **US D501,889 S**
(45) **Date of Patent:** **** Feb. 15, 2005**

(54) **SIGNAGE DISPLAY**

(75) Inventors: **James Harris**, Glencoe, IL (US);
Timothy Donmoyer, Hinsdale, IL (US);
Paul Simon, Wheaton, IL (US)

(73) Assignee: **Equity Office Media Network**,
Chicago, IL (US)

(**) Term: **14 Years**

(21) Appl. No.: **29/197,015**

(22) Filed: **Jan. 8, 2004**

(51) **LOC (7) Cl.** **20-03**

(52) **U.S. Cl.** **D20/39**

(58) **Field of Search** D20/10, 13, 19,
D20/21, 27, 39, 40-42, 99; 40/124.01,
514, 584, 590, 603, 605, 606.12, 607.01,
607.03, 610, 611.1, 612, 624; 362/811-12

(56) **References Cited**

U.S. PATENT DOCUMENTS

D14,619 S	2/1884	Patitz
D20,572 S	3/1891	Oftelie
822,734 A	6/1906	Greenberg
975,035 A	11/1910	Heard
D41,430 S	6/1911	Golden
1,429,274 A	9/1922	Bergeron
D68,032 S	8/1925	Coffey
D82,410 S	11/1930	Attinger
D90,905 S	10/1933	Allen
1,998,640 A	4/1935	Shaw
D110,866 S	8/1938	Johns
D154,299 S	6/1949	Morgan
D164,910 S	10/1951	Freeman

D357,704 S	*	4/1995	Wolff	D19/90
D372,590 S		8/1996	Mann et al.		
D383,497 S		9/1997	Robertson		
D411,050 S		6/1999	Keller et al.		
D446,821 S	*	8/2001	Decaux	D20/39
D447,183 S	*	8/2001	Wilmotte	D20/39
D453,356 S		2/2002	Middlebrook		
6,481,131 B2	*	11/2002	Gianotti et al.	40/546

* cited by examiner

Primary Examiner—Robert M. Spear

(74) *Attorney, Agent, or Firm*—Marshall, Gerstein & Borun LLP

(57) **CLAIM**

The ornamental design for a “signage display,” as shown and described.

DESCRIPTION

FIG. 1 is a left side perspective view taken from the front, left side, and above, showing our new design;
 FIG. 2 is a front elevational view thereof, the rear elevational view being a mirror image thereof;
 FIG. 3 is a left side elevational view thereof, the right side elevational view being a mirror image thereof;
 FIG. 4 is a top view thereof;
 FIG. 5 is a left perspective view taken from the front, left side, and above, of another embodiment thereof;
 FIG. 6 is a front elevational view thereof, the rear elevational view being a mirror image thereof;
 FIG. 7 is a left side elevational view thereof, the right side elevational view being a mirror image thereof; and,
 FIG. 8 is a top plan view thereof.

1 Claim, 8 Drawing Sheets

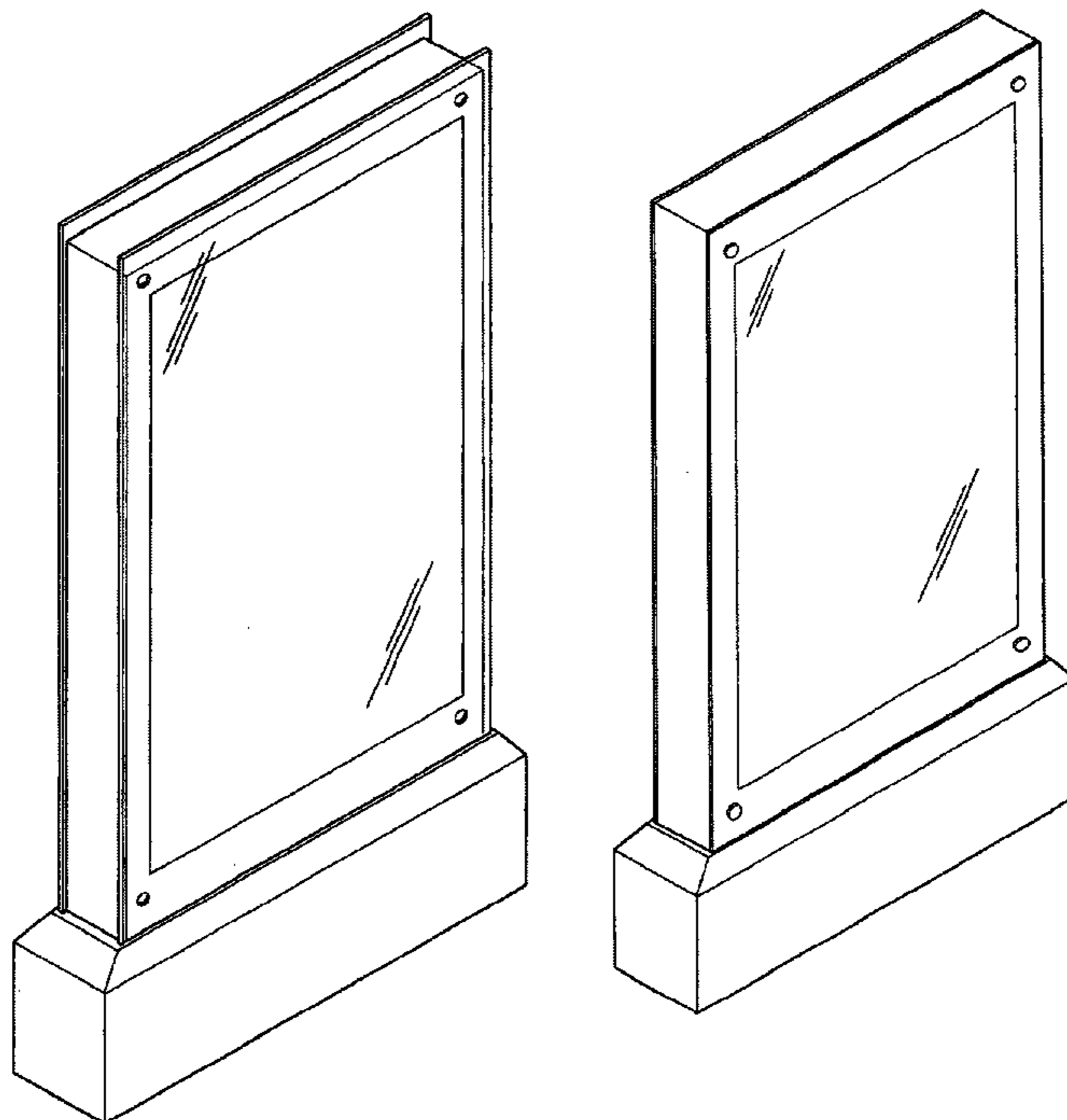

FIG. 1

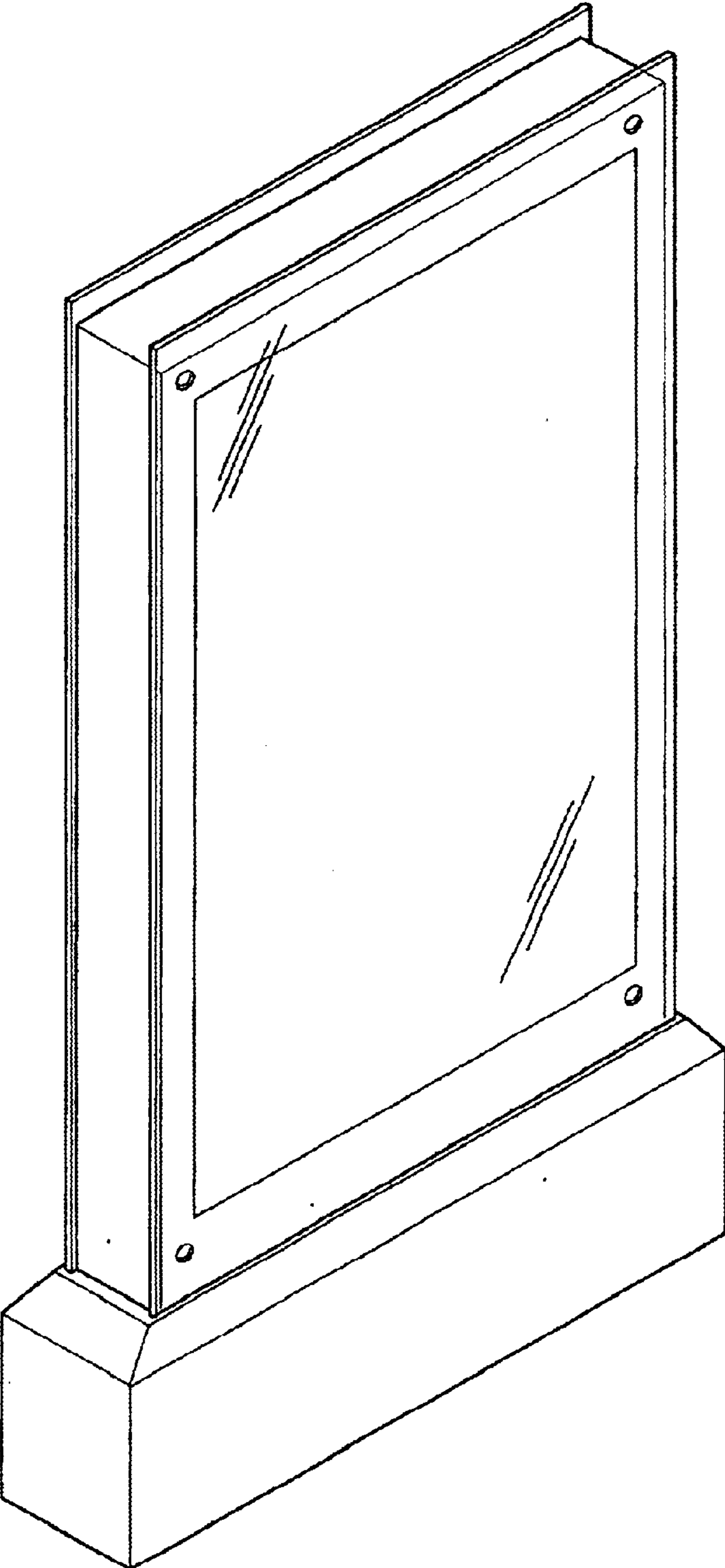

FIG. 2

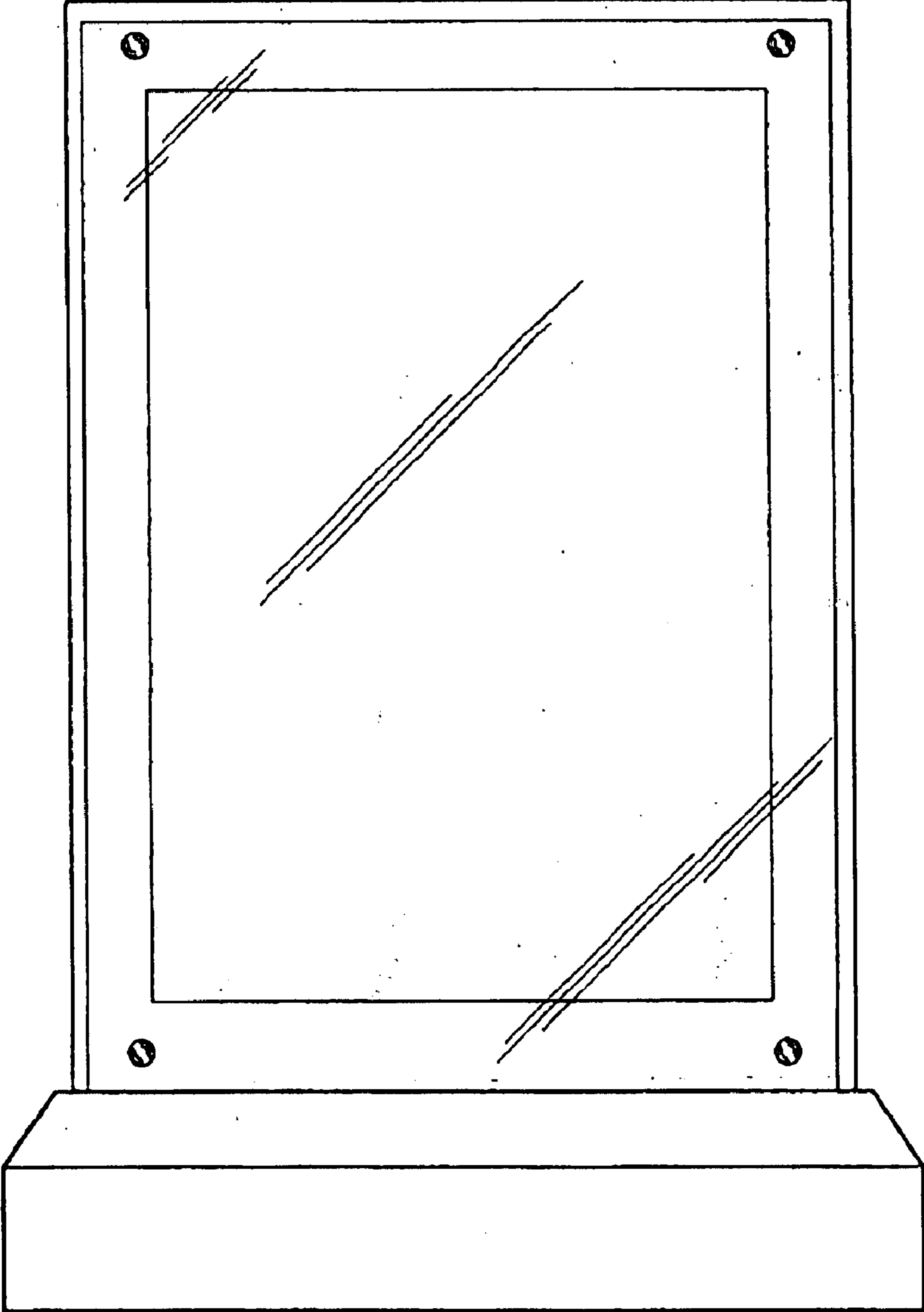

FIG. 3

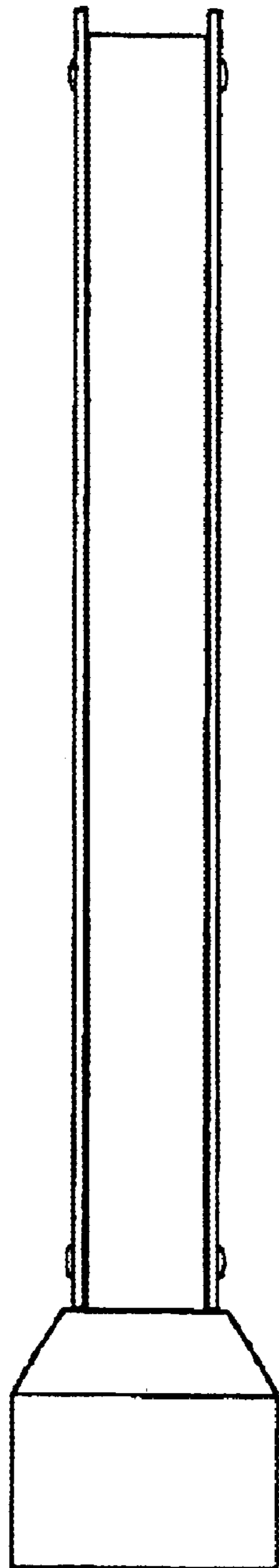

FIG. 4

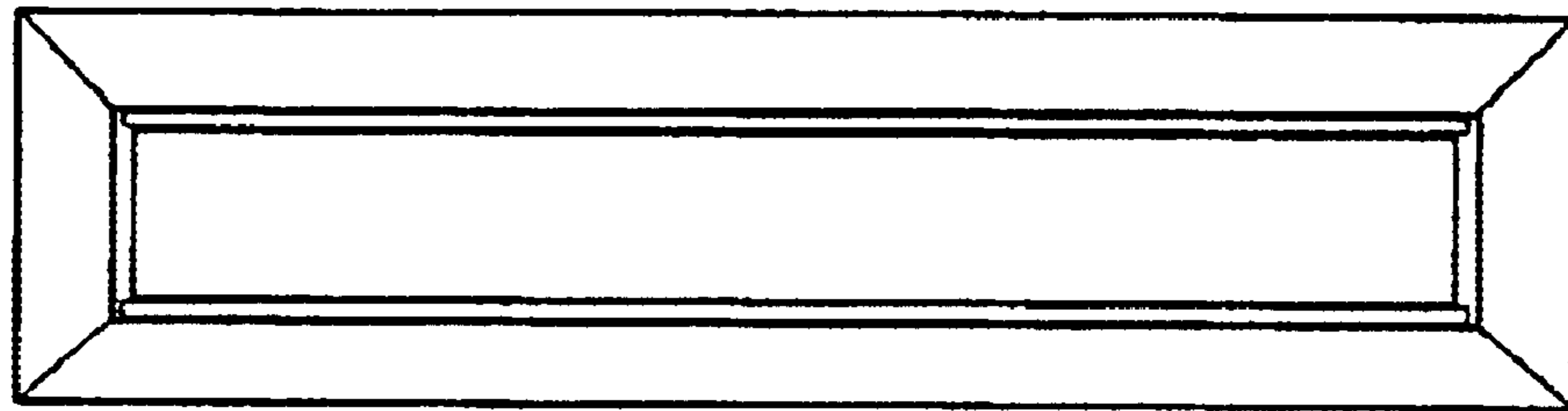

FIG. 5

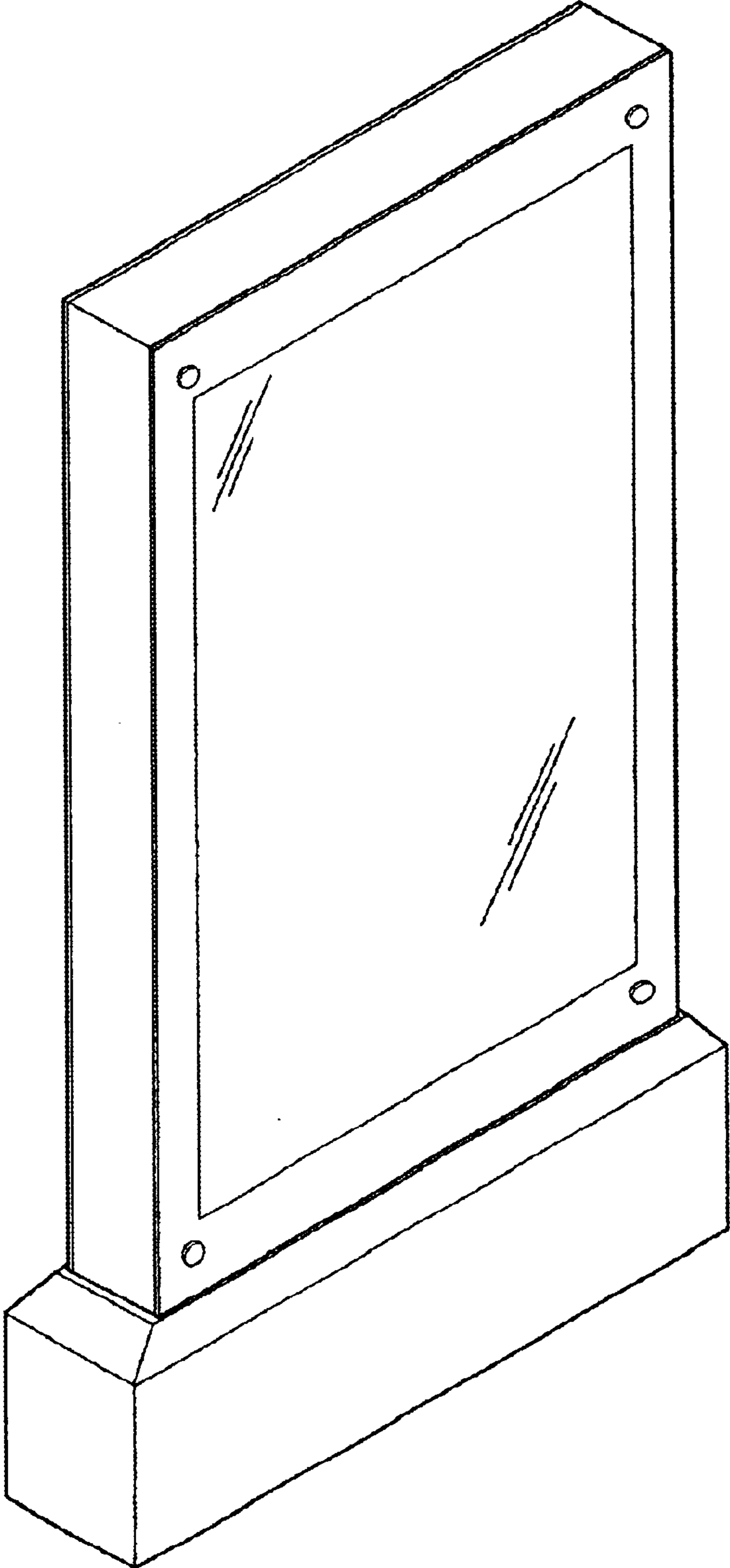

FIG. 6

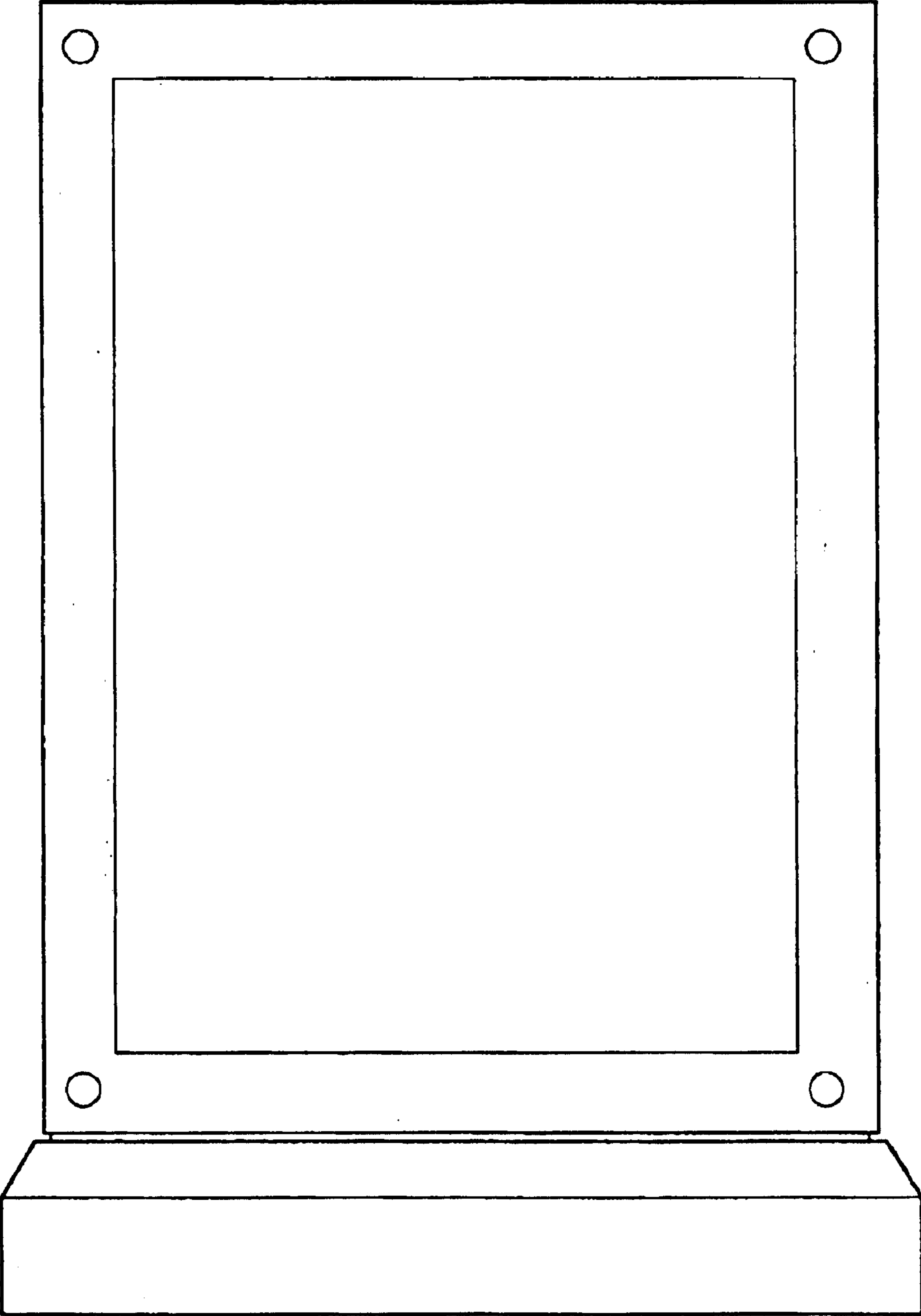

FIG. 7

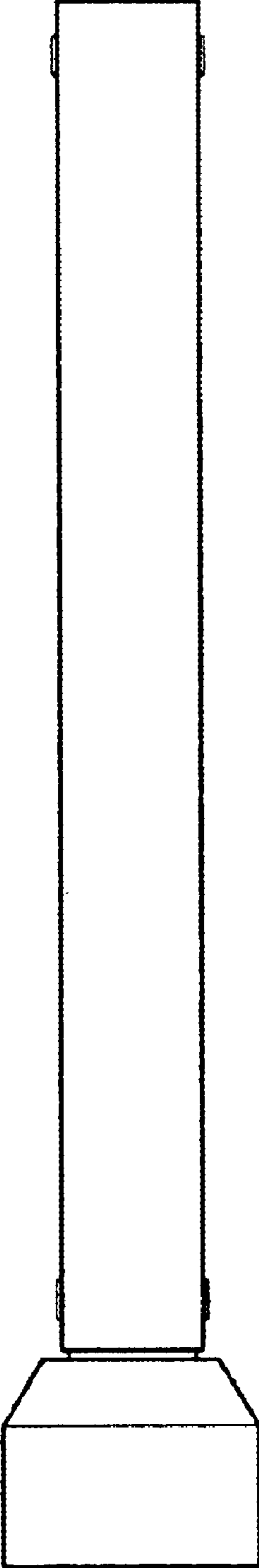

FIG. 8

