

US00D501884S

(12) **United States Design Patent**
Davies et al.

(10) **Patent No.: US D501,884 S**
(45) **Date of Patent: ** Feb. 15, 2005**

(54) **PAPER PUNCH**

(75) Inventors: **Gareth William Humphreys Davies**,
Bridgend (GB); **Simon David Bathard**,
Bridgend (GB)

(73) Assignee: **Tonic Studios Limited**, Bridgend (GB)

(**) Term: **14 Years**

(21) Appl. No.: **29/203,569**

(22) Filed: **Apr. 16, 2004**

(30) **Foreign Application Priority Data**

Oct. 18, 2003 (GB) 3014838

(51) **LOC (7) Cl.** **19-02**

(52) **U.S. Cl.** **D19/72; D8/50**

(58) **Field of Search** D19/65, 75, 72,
D19/95, 99, 100, 73; D8/49-50, 98, 105;
30/229, 285, 289, 294, DIG. 3, 358, 363,
364; 83/167, 465, 467, 550, 560, 588, 627,
633; 227/134; 206/340

(56) **References Cited**

U.S. PATENT DOCUMENTS

200,774 A * 2/1878 Somers 227/134
2,224,461 A * 12/1940 Obstfeld 206/340

D133,209 S * 7/1942 Heller D8/50
2,874,464 A * 2/1959 Petersen 30/229
D373,385 S * 9/1996 Birkholz D19/72
5,601,006 A * 2/1997 Quinn et al. 83/588
D420,049 S * 2/2000 Robillard D19/72
D463,497 S * 9/2002 Breche D19/72
D463,498 S * 9/2002 Breche D19/72

* cited by examiner

Primary Examiner—Martie K. Holtje

(74) *Attorney, Agent, or Firm*—Millen, White, Zelano &
Branigan, P.C.

(57) **CLAIM**

The ornamental design for a paper punch, as shown and
described.

DESCRIPTION

FIG. 1 is a top, right rear perspective view of a paper punch
showing our new design;
FIG. 2 is a top, left front perspective view thereof;
FIG. 3 is a rear elevational view thereof;
FIG. 4 is a front elevational view thereof;
FIG. 5 is a left side elevational view, the right side being a
mirror image thereof;
FIG. 6 is a top plan view thereof; and,
FIG. 7 is a bottom plan view thereof.

1 Claim, 5 Drawing Sheets

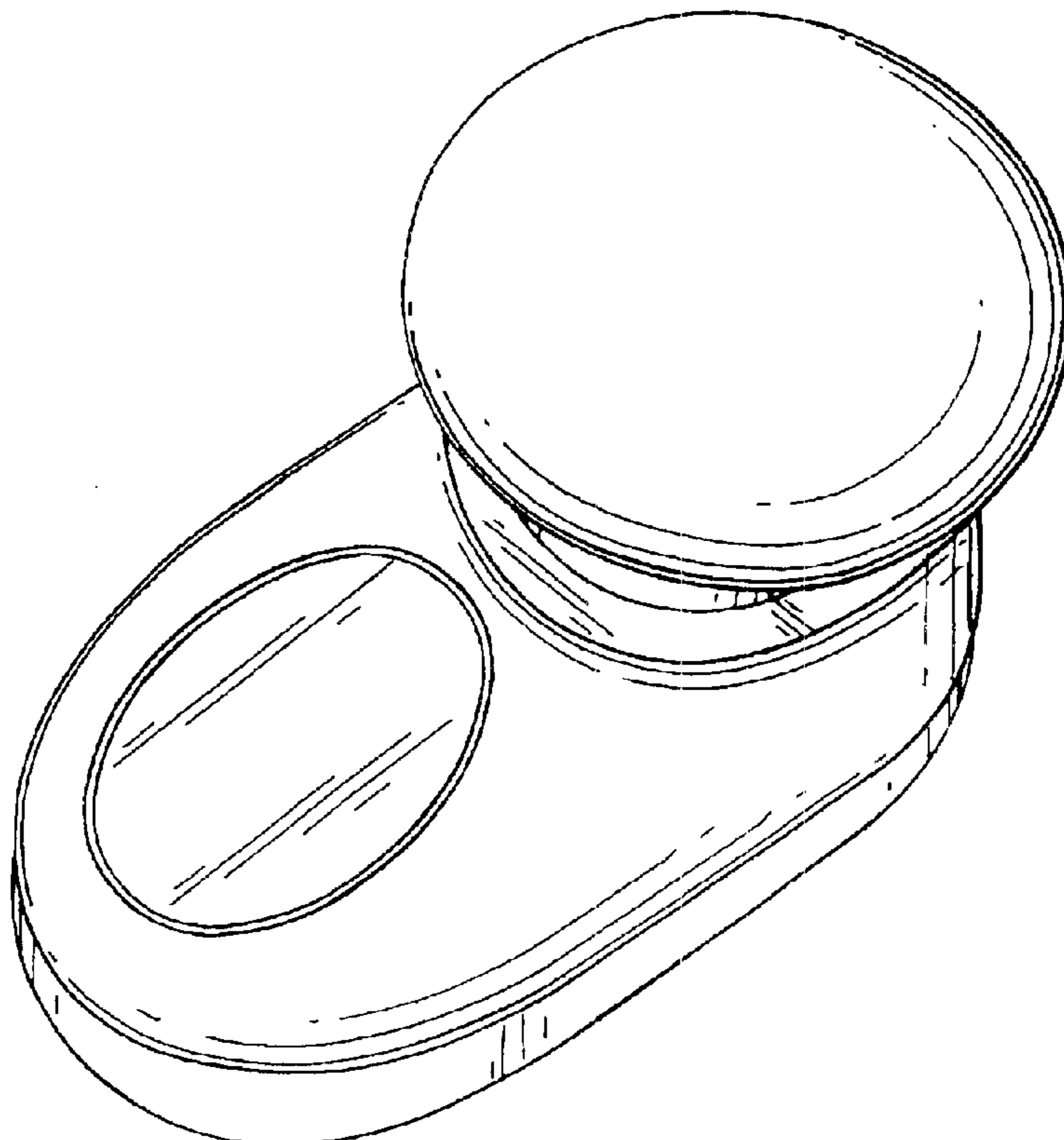

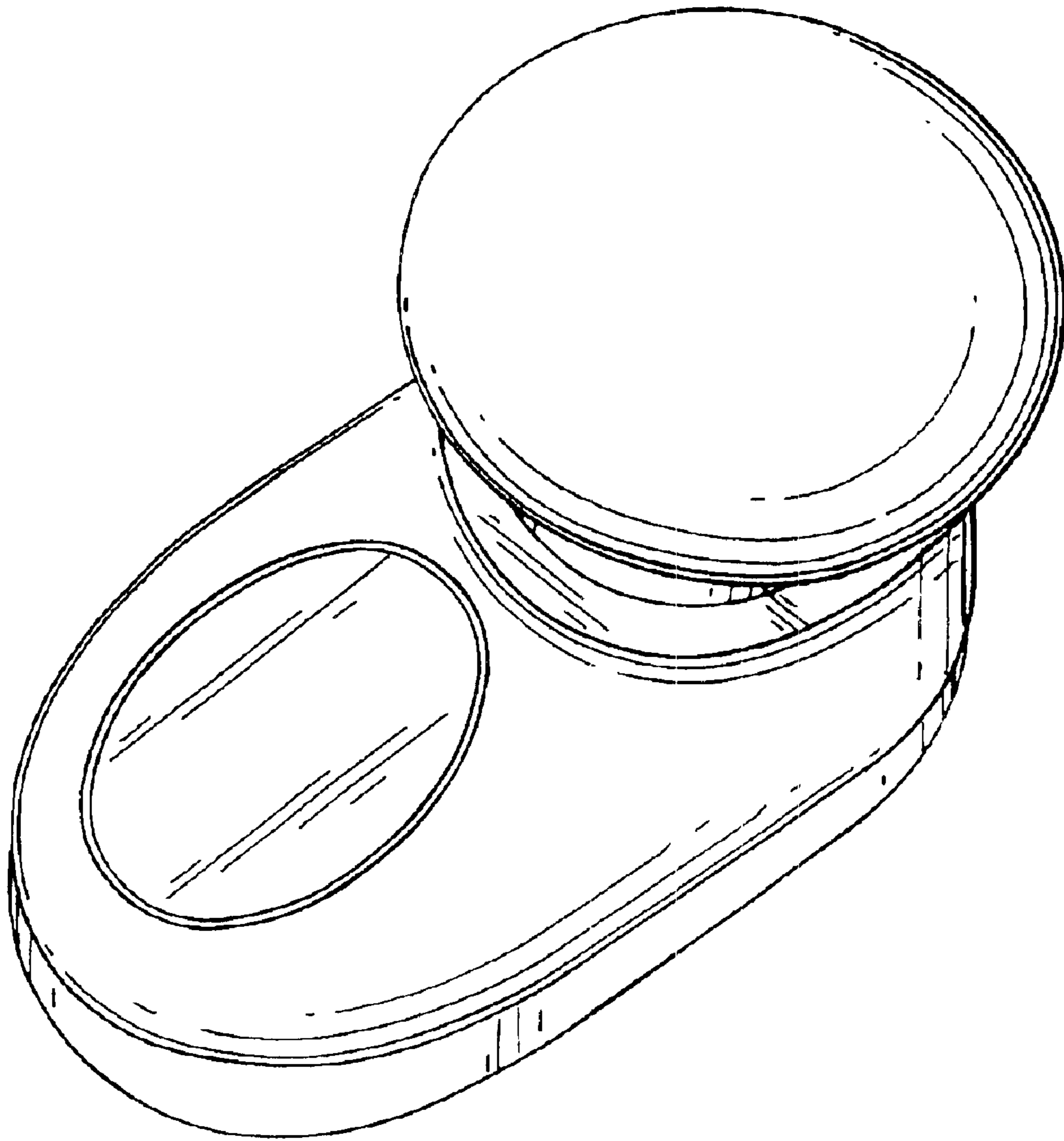

Fig. 1

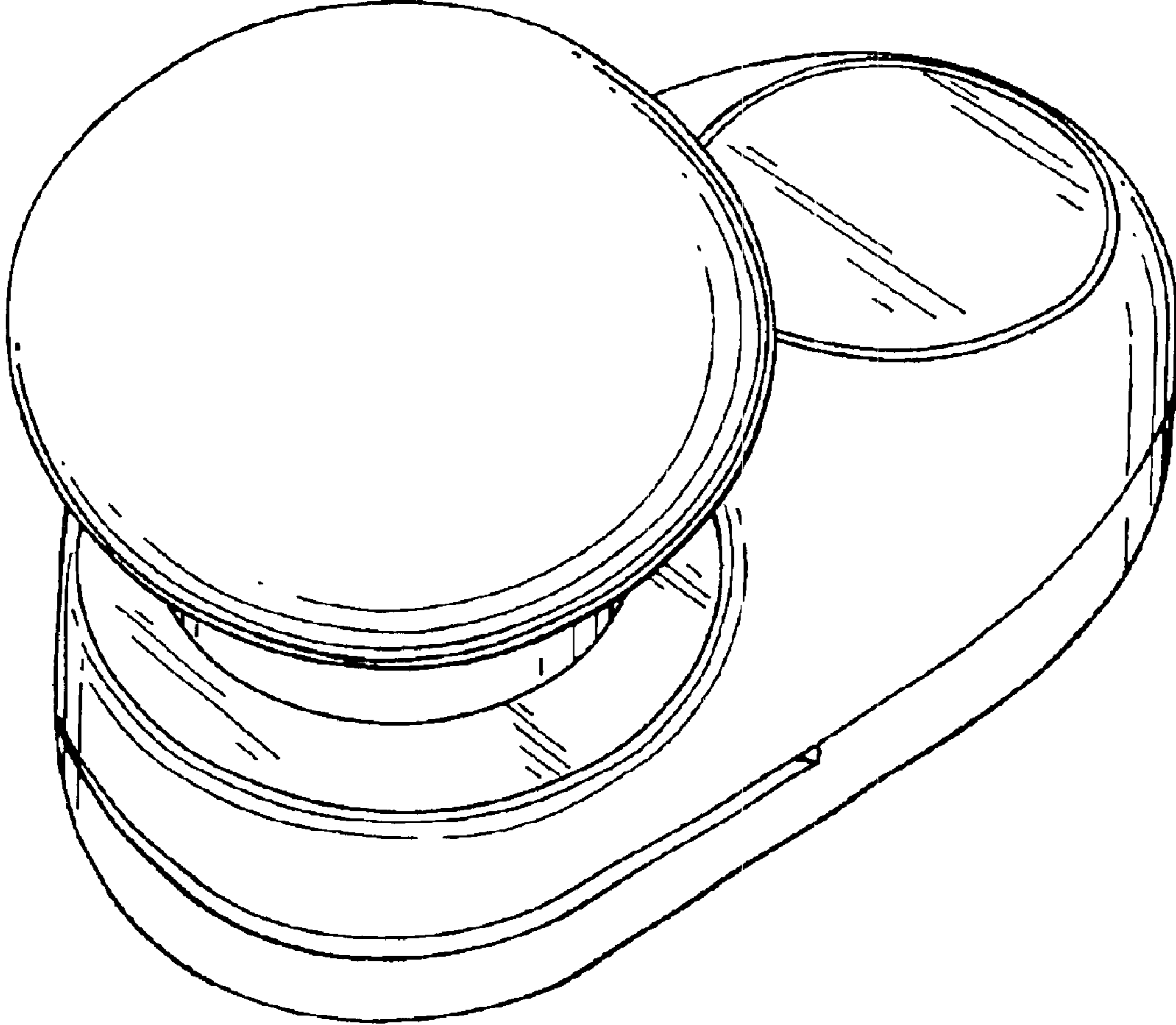

Fig. 2

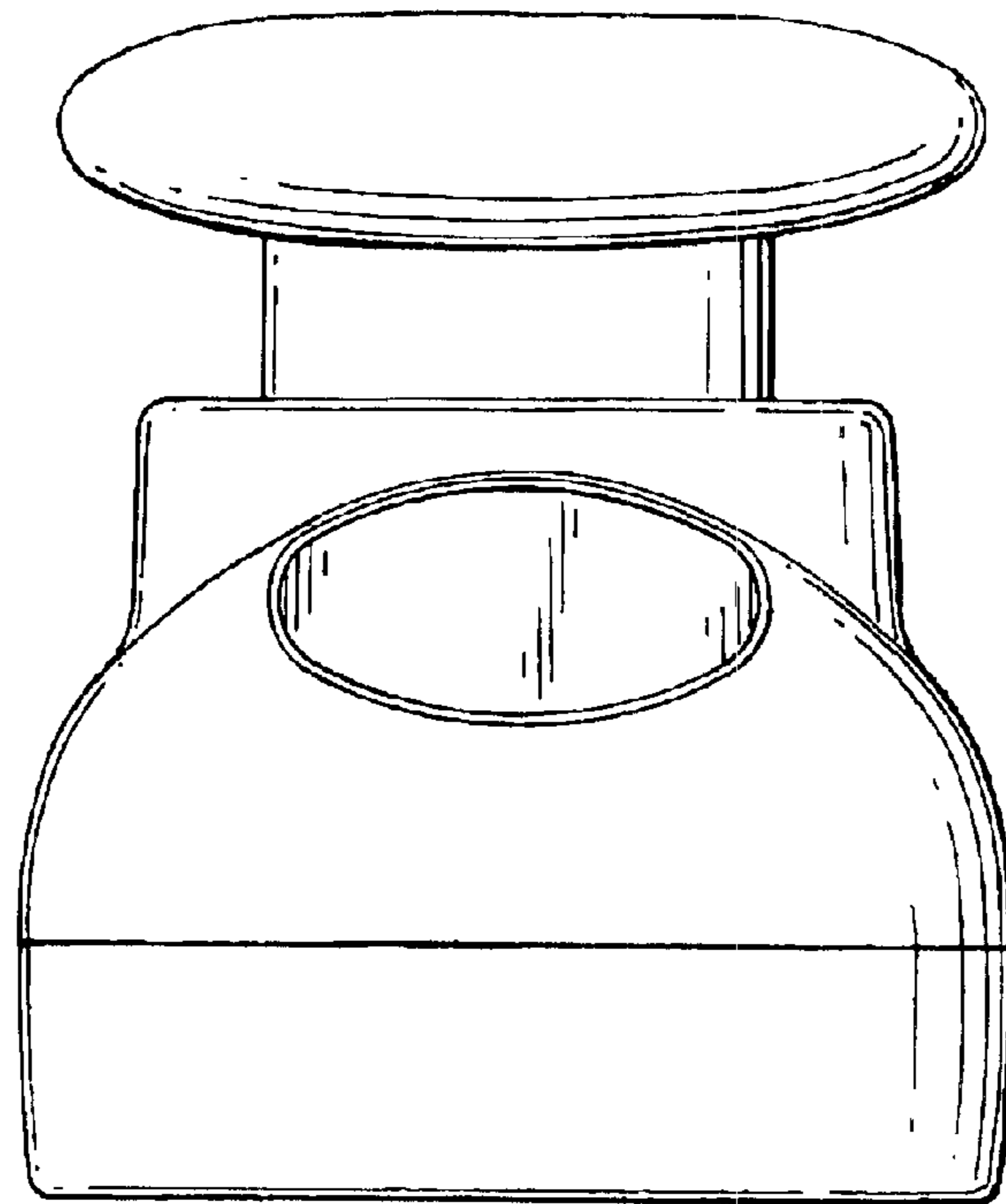

Fig. 3

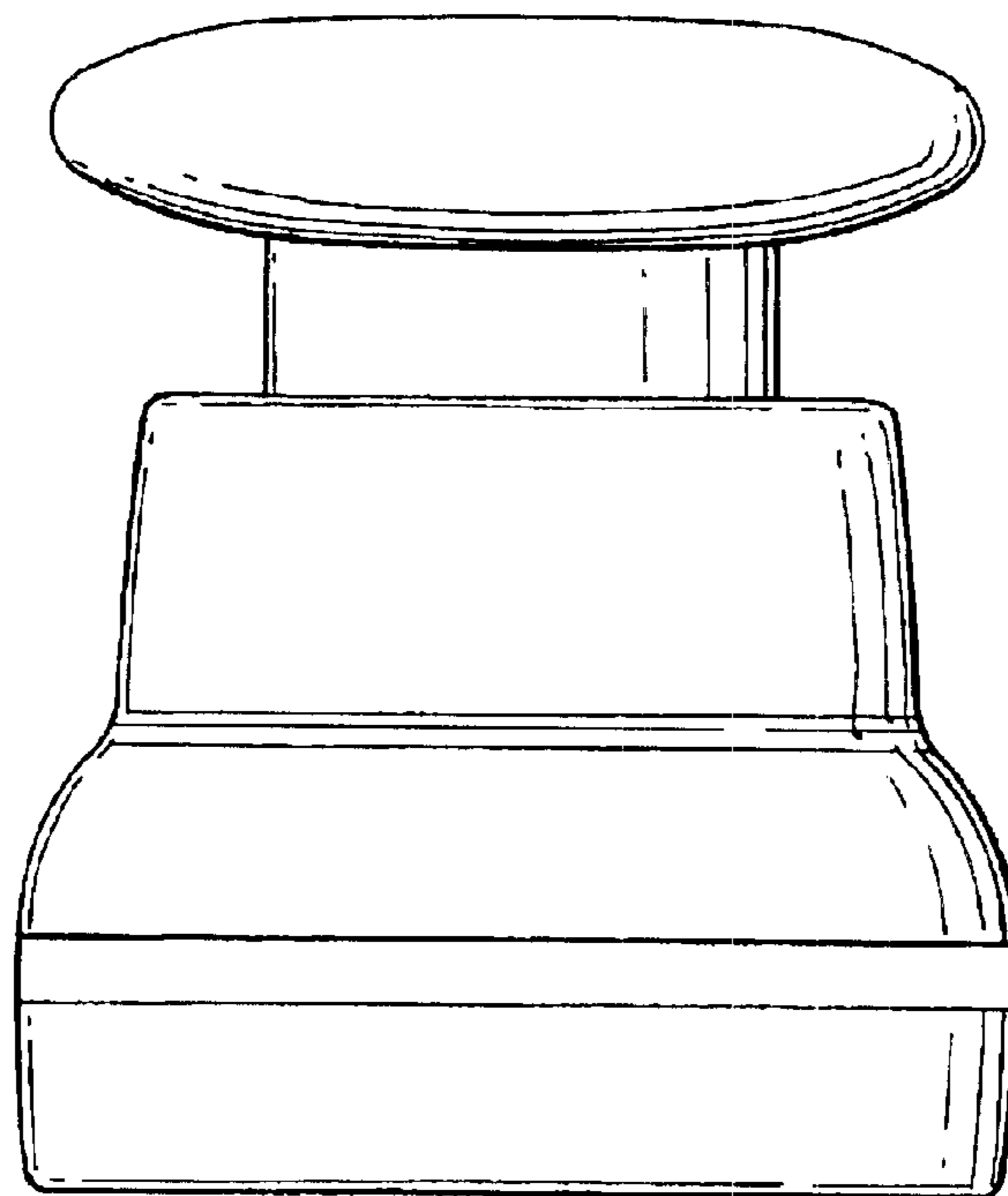

Fig. 4

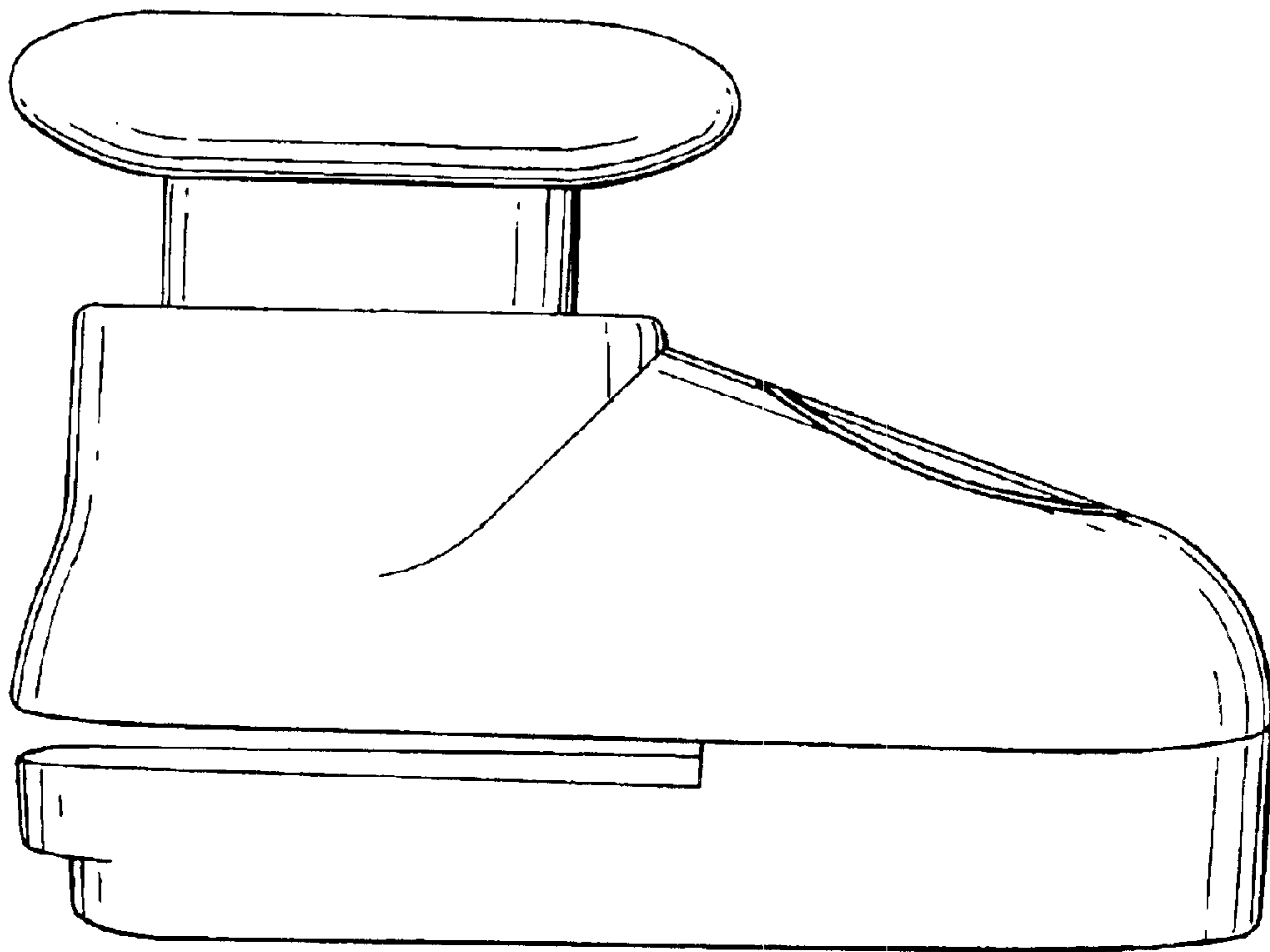

Fig. 5

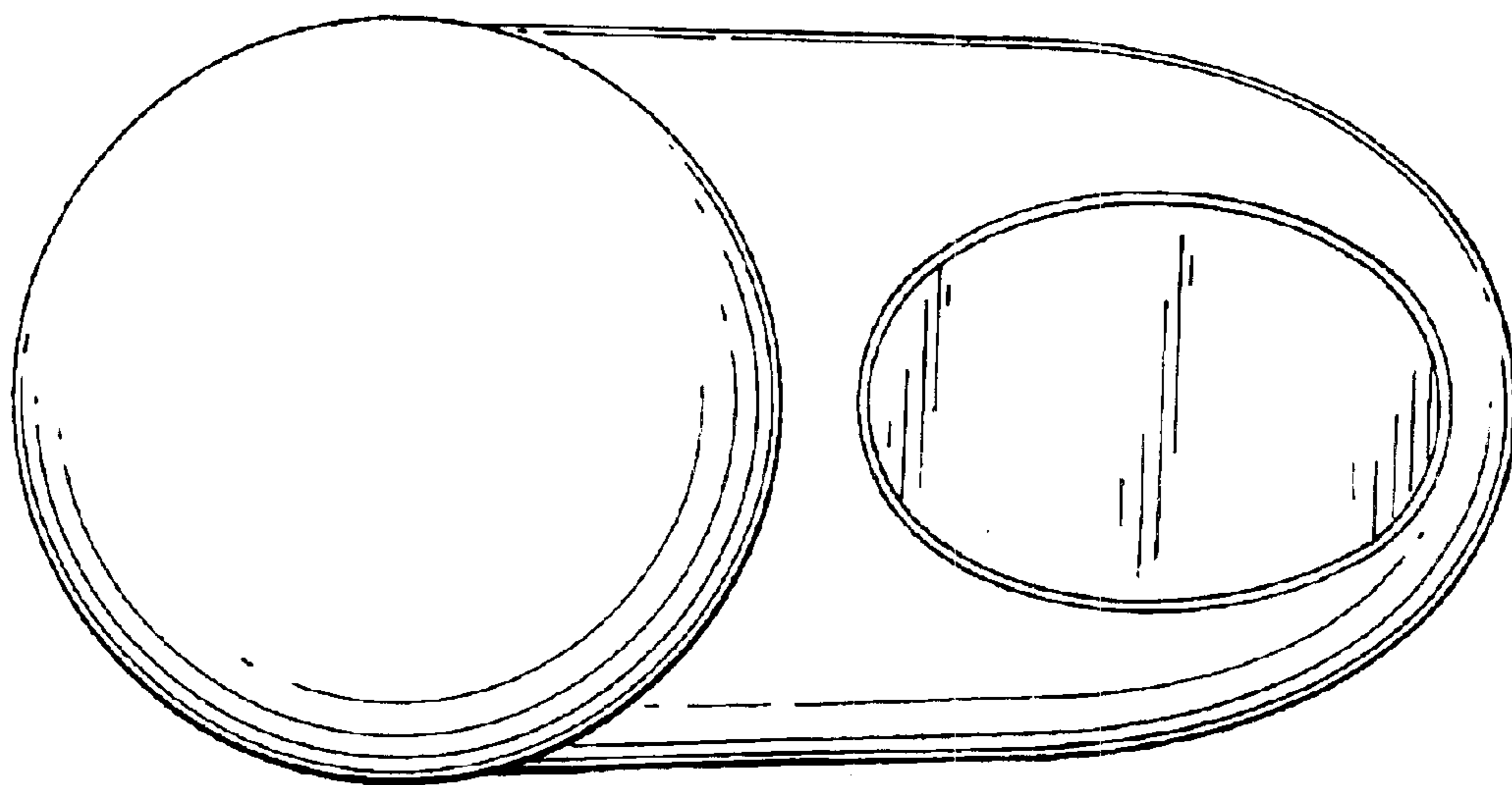

Fig. 6

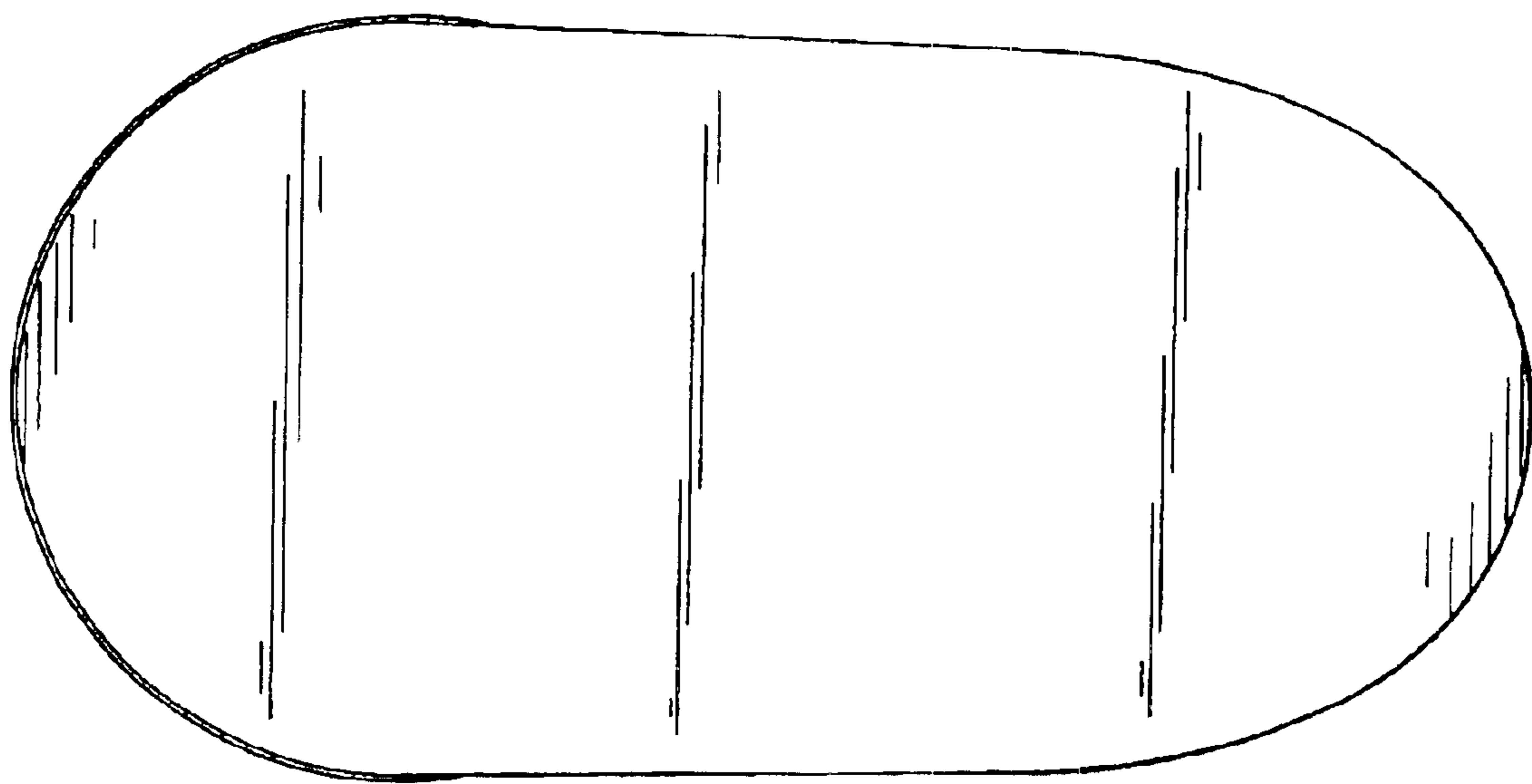

Fig. 7