

US00D501859S

(12) **United States Design Patent**  
**Presta**

(10) **Patent No.:** **US D501,859 S**

(45) **Date of Patent:** **\*\* Feb. 15, 2005**

(54) **FOOD PRESERVATION APPARATUS**

(75) Inventor: **Matthew P. Presta**, San Mateo, CA (US)

(73) Assignee: **Tilia International, Inc.**, San Francisco, CA (US)

(\*\*) Term: **14 Years**

(21) Appl. No.: **29/181,575**

(22) Filed: **May 13, 2003**

(51) **LOC (7) Cl.** ..... **15-09**

(52) **U.S. Cl.** ..... **D15/146**

(58) **Field of Search** ..... D15/123; 100/155 R,  
100/160, 176; 156/555, 560, 582, 583.1,  
351, 353, 364, 366, 522

(56) **References Cited**

**U.S. PATENT DOCUMENTS**

6,315,020 B1 \* 11/2001 Seki ..... 156/351  
D453,171 S \* 1/2002 Cheng ..... D15/146

\* cited by examiner

*Primary Examiner*—Antoine D. Davis

(74) *Attorney, Agent, or Firm*—Perkins Coie LLP

(57) **CLAIM**

The ornamental design for a food preservation apparatus, as shown and described.

**DESCRIPTION**

FIG. 1 is an illustrative top view of a food preservation apparatus, in a closed position.

FIG. 2 is a front view of the food preservation apparatus shown in FIG. 1, in the closed position.

FIG. 3 is a rear view of the food preservation apparatus shown in FIG. 1, in the closed position.

FIG. 4 is a left side elevation view of the food preservation apparatus shown in FIG. 1, in a closed position.

FIG. 5 is a right side elevation view of the food preservation apparatus shown in FIG. 1, in a closed position.

FIG. 6 is a bottom side view of the food preservation apparatus shown in FIG. 1, in the closed position; and,

FIG. 7 is a perspective view of the food preservation apparatus shown in FIG. 1, in a closed position.

**1 Claim, 6 Drawing Sheets**

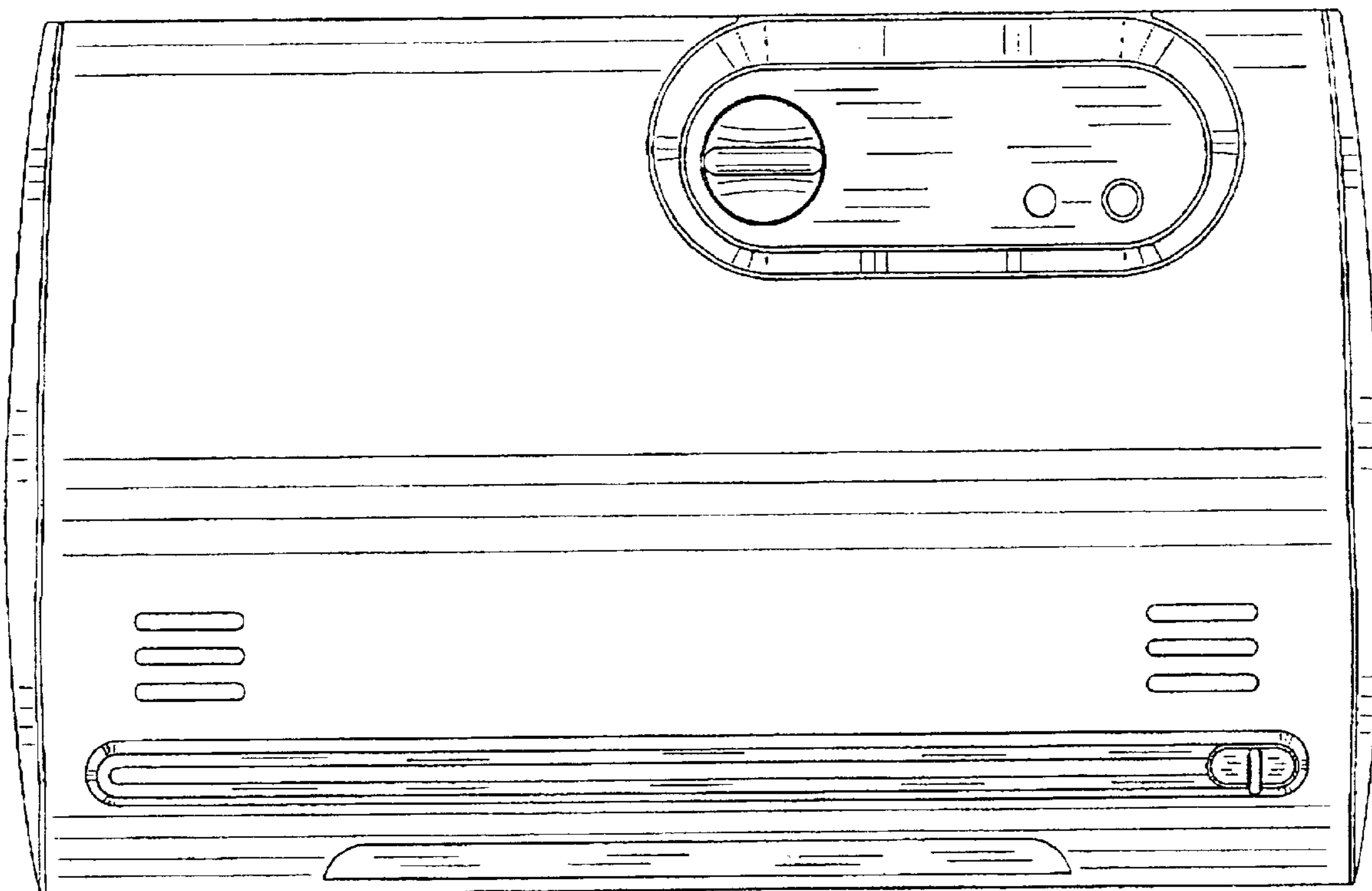

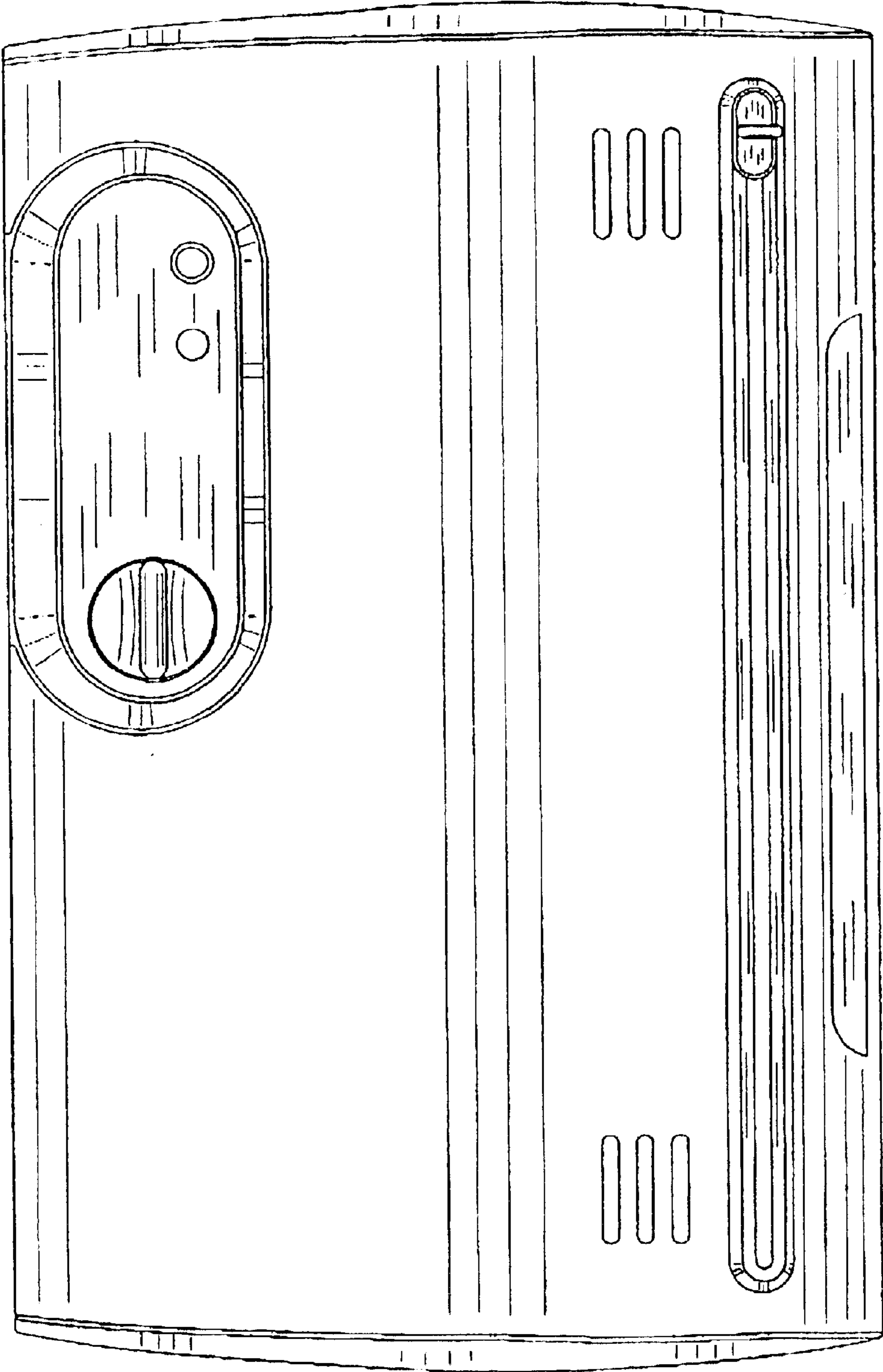

FIG. 1

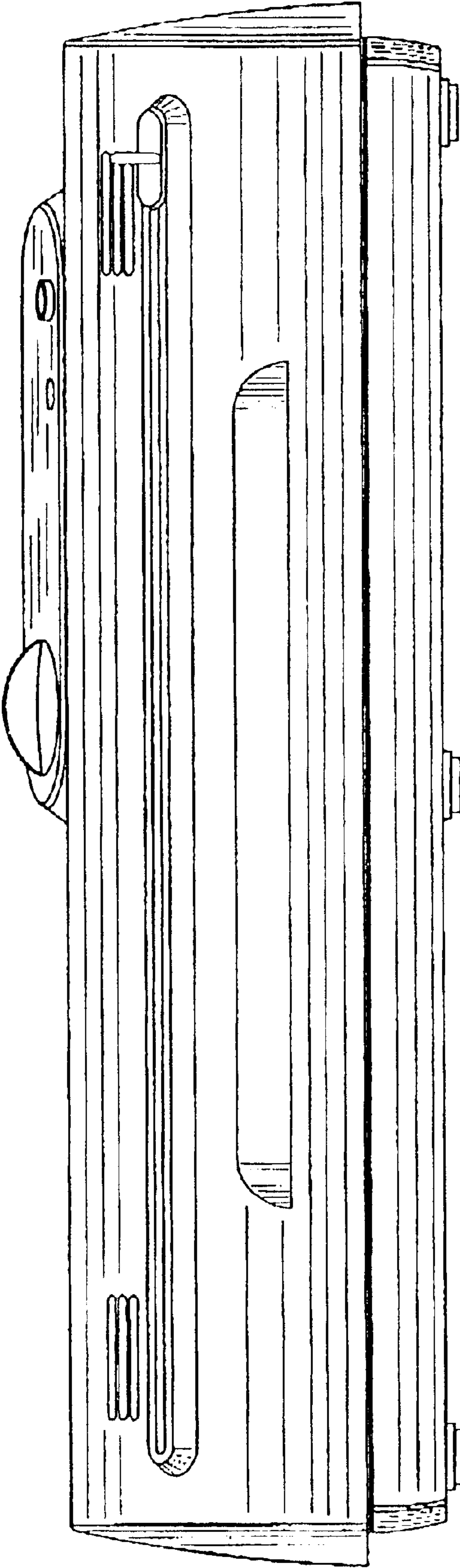

FIG. 2

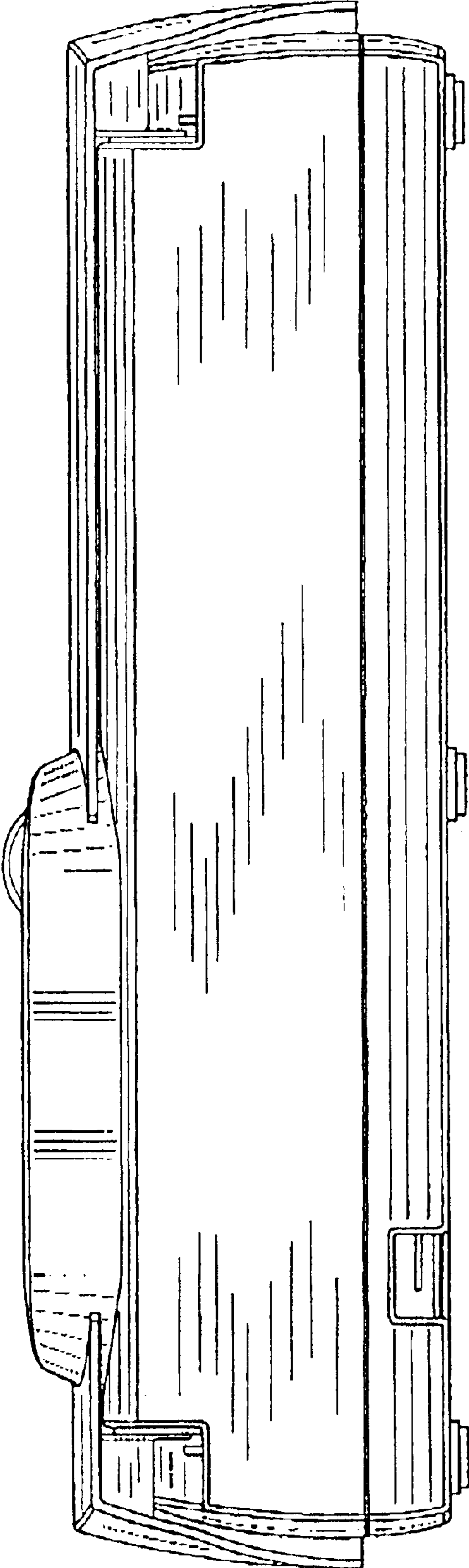

FIG. 3

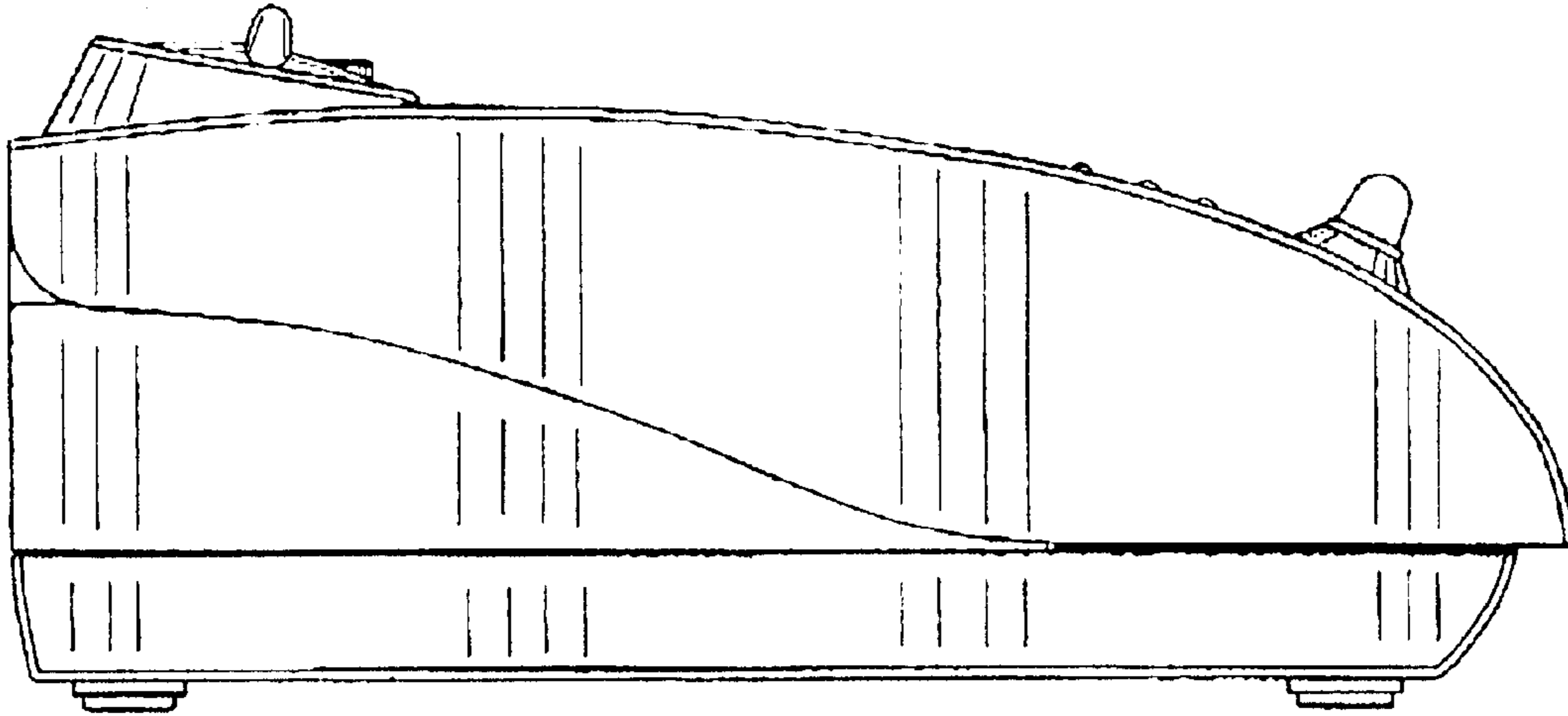

FIG. 4

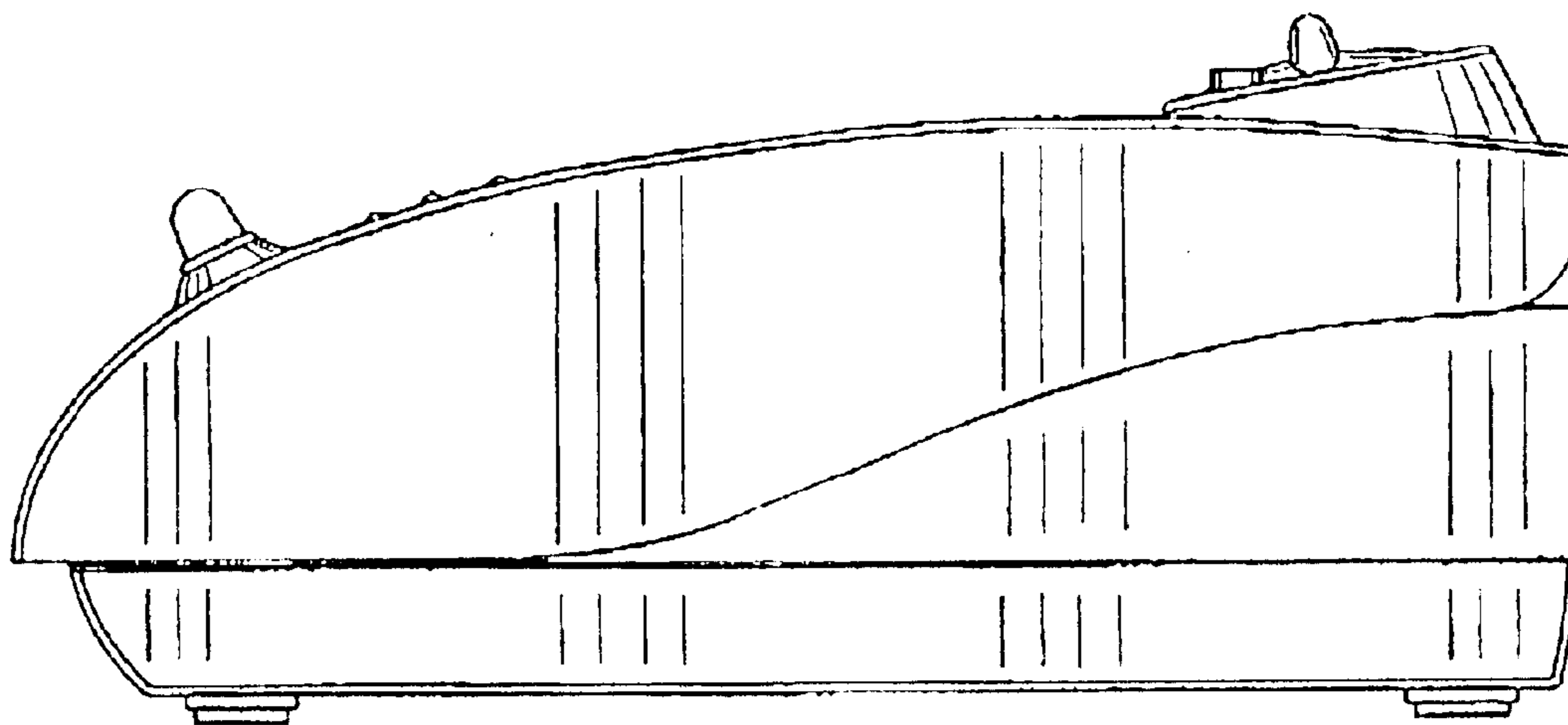

FIG. 5

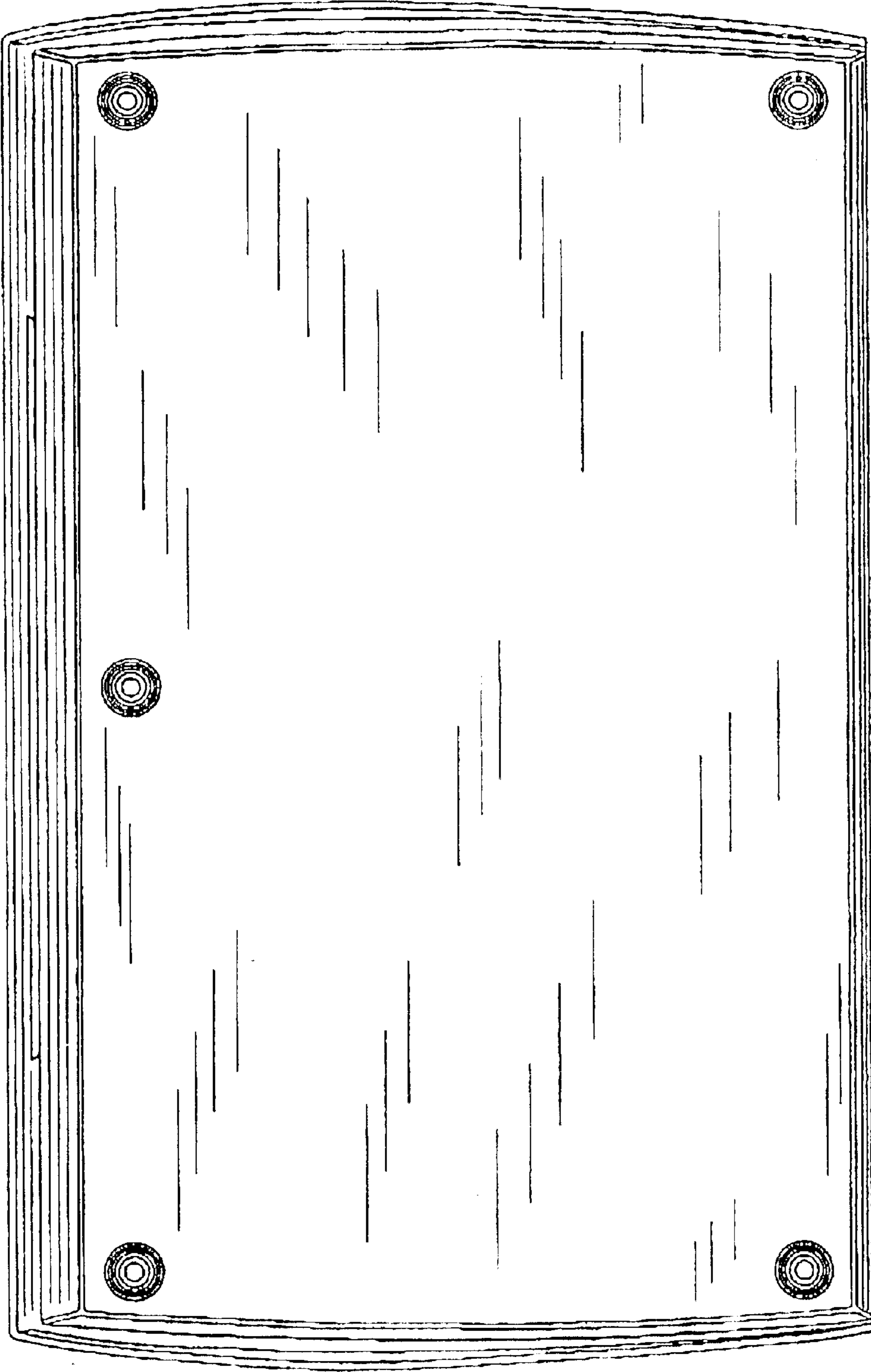

FIG. 6

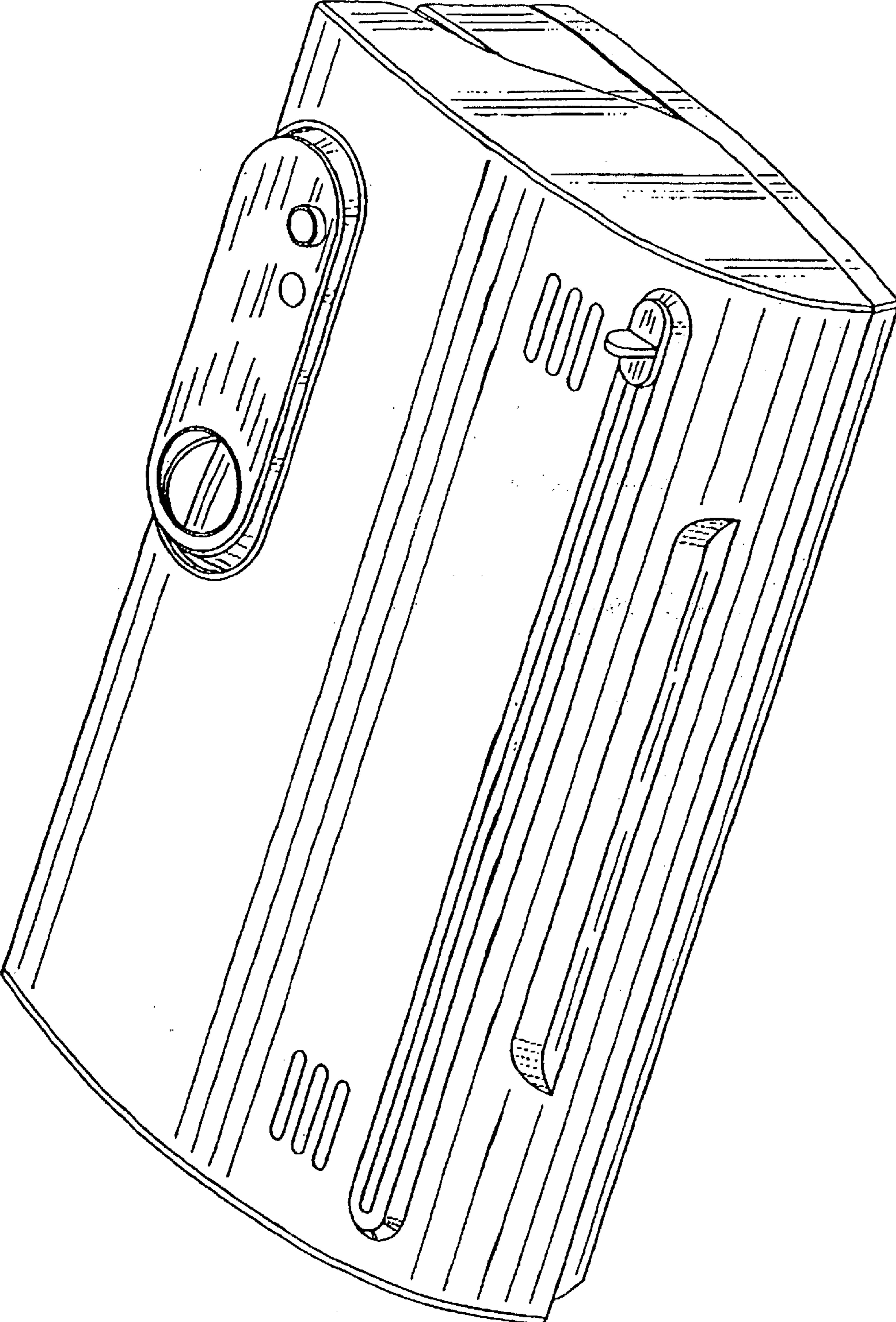

FIG. 7