

US00D501851S

(12) **United States Design Patent**  
**Watanabe et al.**

(10) **Patent No.: US D501,851 S**  
(45) **Date of Patent: \*\* Feb. 15, 2005**

(54) **PORTABLE WIRELESS TELEPHONE**

(75) Inventors: **Jun Watanabe, Tokyo (JP); Kazuo Oosawa, Tokyo (JP); Masakatsu Takizawa, Tokyo (JP)**

(73) Assignee: **NEC Corporation, Tokyo (JP)**

(\*\*) Term: **14 Years**

(21) Appl. No.: **29/202,975**

(22) Filed: **Apr. 8, 2004**

(30) **Foreign Application Priority Data**

Oct. 10, 2003 (JP) ..... 2003-029935

(51) **LOC (7) Cl. .... 14-03**

(52) **U.S. Cl. .... D14/248**

(58) **Field of Search** ..... D14/137, 138,  
D14/218, 147-148, 247-248, 144, 341-347;  
379/433.01-433.13, 419, 434, 428.01-428.04,  
420.01-420.04, 440; 455/550.1-90.3; D21/517;  
D13/168; 345/168, 169

(56) **References Cited**

**U.S. PATENT DOCUMENTS**

- D410,929 S \* 6/1999 Nagele et al. .... D14/248
- D418,146 S \* 12/1999 Frye et al. .... D14/248
- D423,516 S \* 4/2000 Frye et al. .... D14/248
- D447,133 S \* 8/2001 Arbisi et al. .... D14/248
- D456,393 S \* 4/2002 Kim et al. .... D14/248
- D458,594 S \* 6/2002 Jang ..... D14/138
- D460,961 S \* 7/2002 Ikenaga et al. .... D14/248
- D475,689 S \* 6/2003 Shimazu et al. .... D14/138
- D477,296 S \* 7/2003 Minamide ..... D14/138
- D485,248 S \* 1/2004 Ogawa ..... D14/138
- D485,249 S \* 1/2004 Liao et al. .... D14/138
- D485,818 S \* 1/2004 Yabe et al. .... D14/138
- D487,443 S \* 3/2004 Yoon ..... D14/138
- D489,344 S \* 5/2004 Lee et al. .... D14/138

- D489,345 S \* 5/2004 Shimamura et al. .... D14/138
- D490,065 S \* 5/2004 Shimazu et al. .... D14/138
- D491,906 S \* 6/2004 Okamatsu ..... D14/138
- D491,907 S \* 6/2004 Ogawa ..... D14/138
- D492,275 S \* 6/2004 Lin et al. .... D14/138
- D492,300 S \* 6/2004 Lee et al. .... D14/248
- D495,689 S \* 9/2004 Lee et al. .... D14/248
- D496,014 S \* 9/2004 Lodato et al. .... D14/138
- D496,016 S \* 9/2004 Hoo ..... D14/138
- D496,019 S \* 9/2004 Okada et al. .... D14/138
- 2004/0014488 A1 \* 1/2004 Sawayama et al. .... 455/550.1
- 2004/0058715 A1 \* 3/2004 Taniguchi et al. .... 455/566
- 2004/0077384 A1 \* 4/2004 Makino et al. .... 455/575.1
- 2004/0077385 A1 \* 4/2004 Makino et al. .... 455/575.1
- 2004/0132513 A1 \* 7/2004 Taneda et al. .... 455/575.3
- 2004/0142734 A1 \* 7/2004 Kim ..... 455/575.1

**FOREIGN PATENT DOCUMENTS**

- JP 1167658 \* 3/2003
- WO DM/064560 \* 10/2003

\* cited by examiner

*Primary Examiner*—Jeffrey Asch

(74) *Attorney, Agent, or Firm*—Sughrue Mion, PLLC

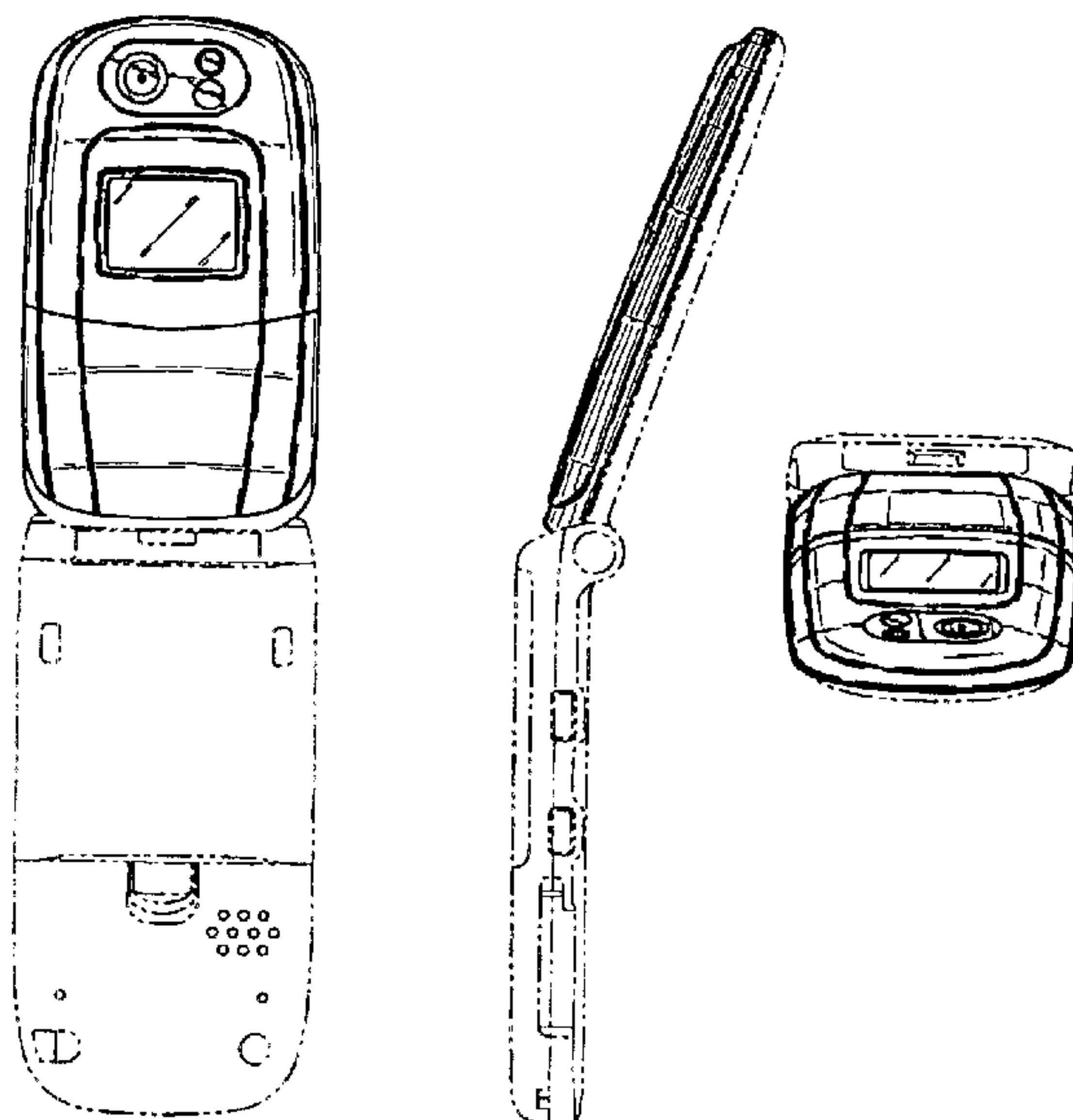
(57) **CLAIM**

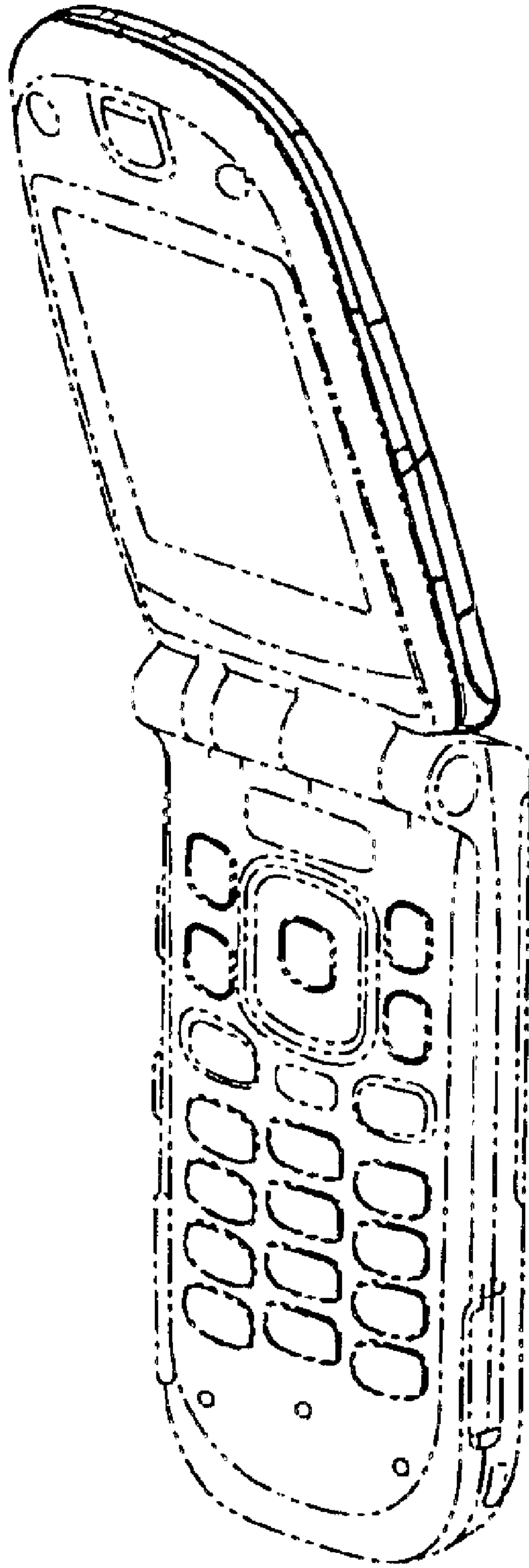
The ornamental design for a portable wireless telephone, as shown.

**DESCRIPTION**

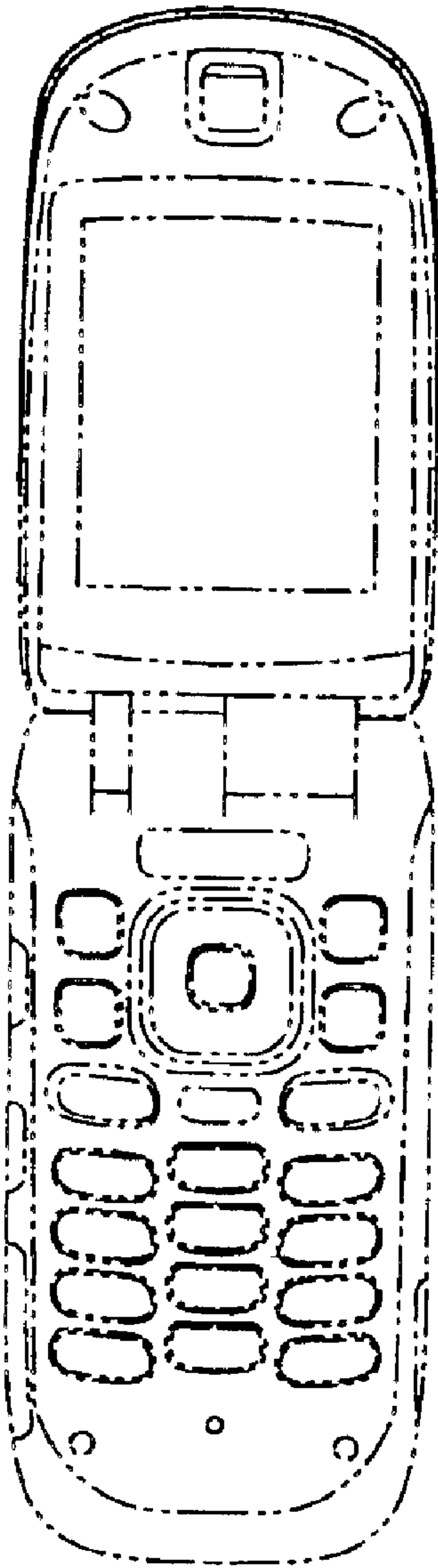
FIG. 1 is a perspective view of the top, front and right side of portable wireless telephone showing our new design; FIG. 2 is a front elevational view thereof; FIG. 3 is a rear elevational view thereof; FIG. 4 is a left side elevational view thereof; FIG. 5 is a right side elevational view thereof; FIG. 6 is a top plan view thereof; and, FIG. 7 is a bottom plan view thereof.

**1 Claim, 3 Drawing Sheets**

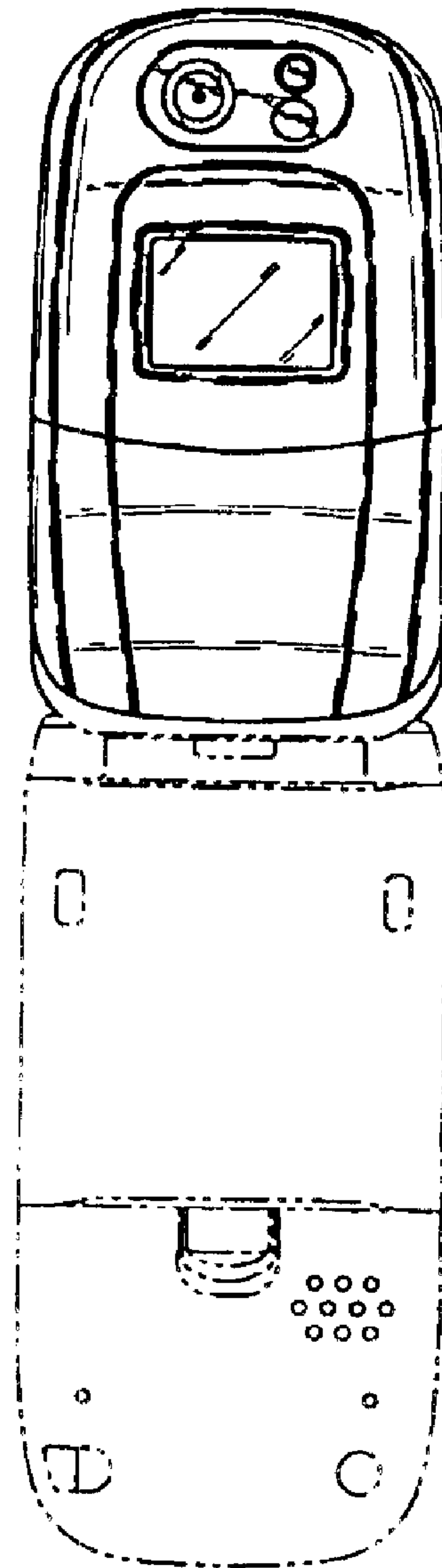




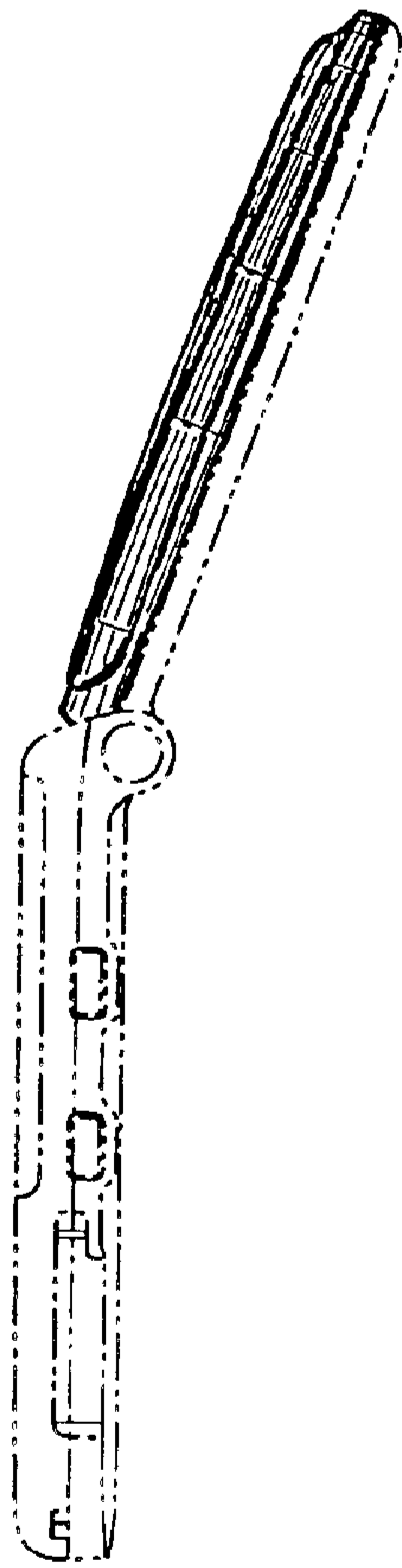
*Fig. 1*



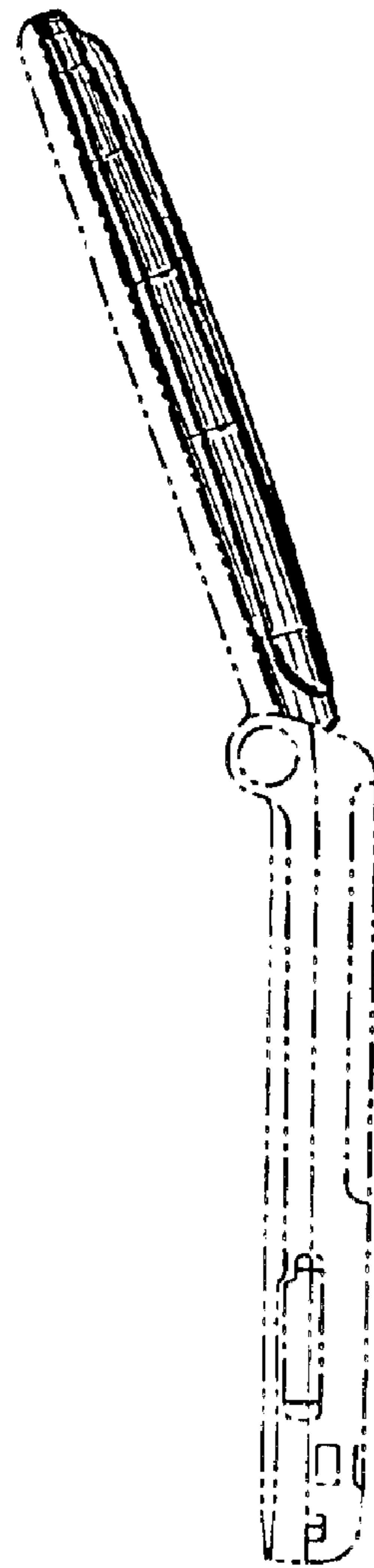
*Fig. 2*



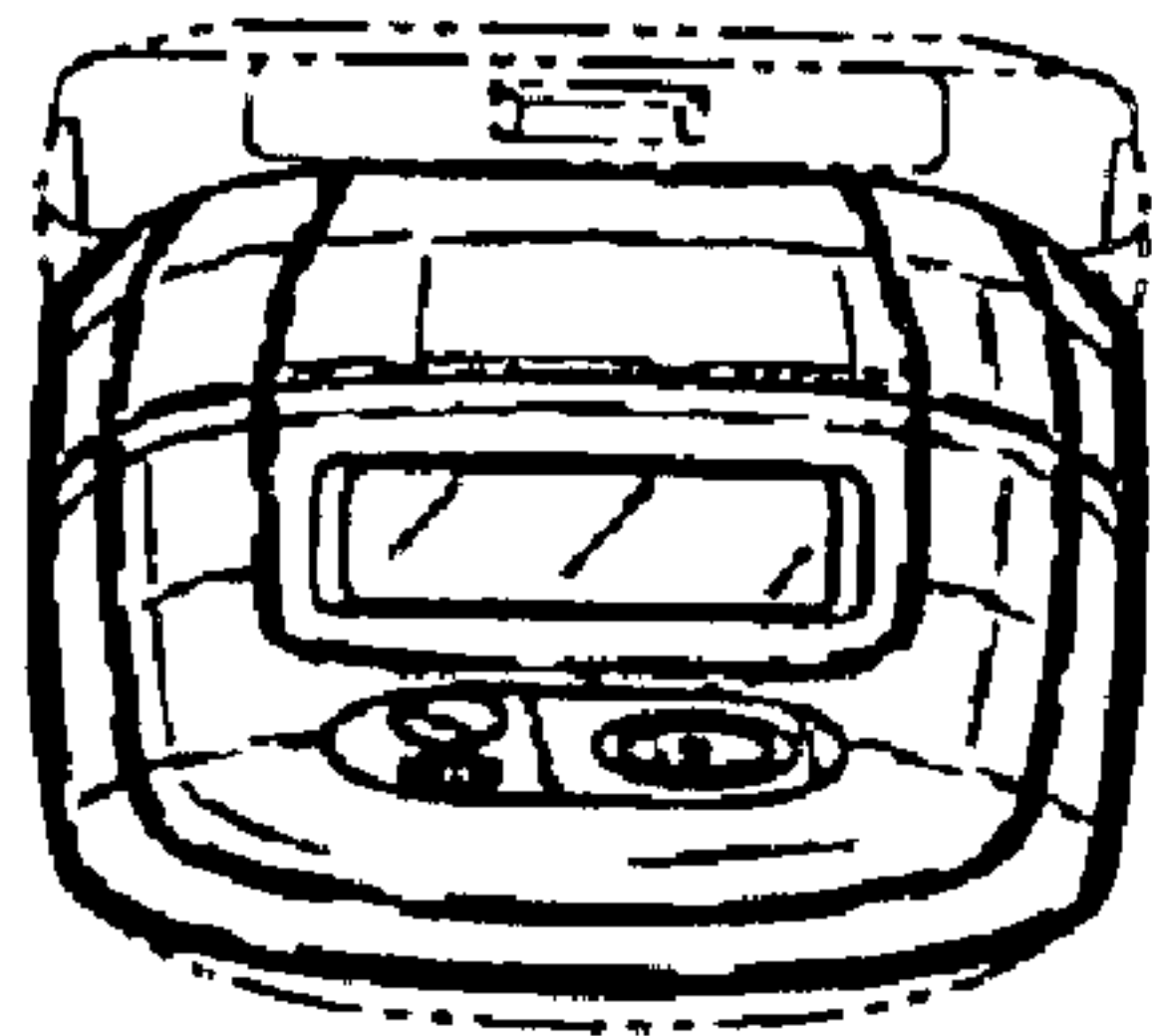
*Fig. 3*



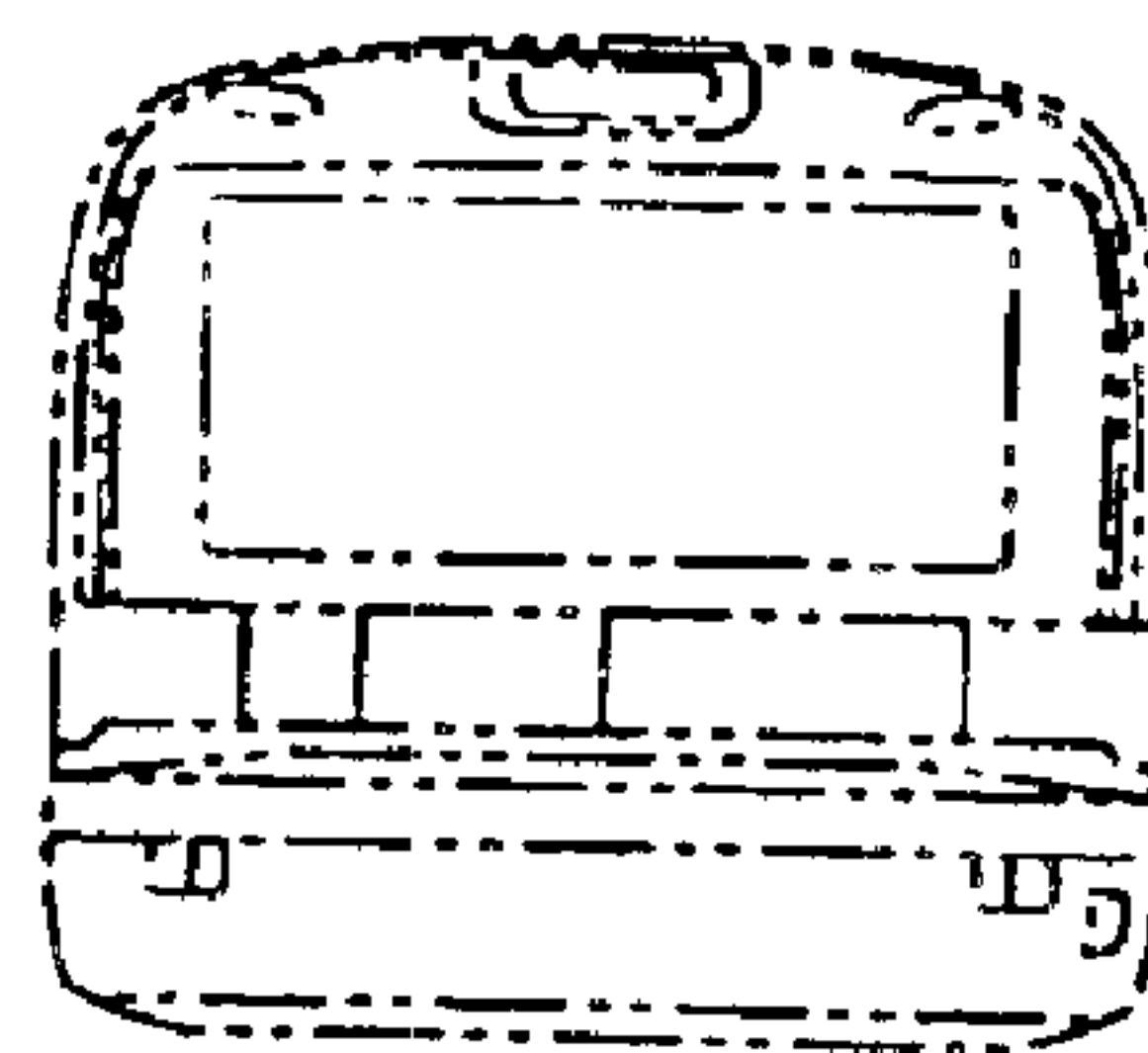
*Fig. 4*



*Fig. 5*



*Fig. 6*



*Fig. 7*