



US00D501774S

(12) **United States Design Patent**
Bates et al.

(10) **Patent No.: US D501,774 S**
(45) **Date of Patent: ** Feb. 15, 2005**

(54) **FOIL CUTTER**

(75) Inventors: **Mathew M Bates**, County Cork (IE);
Diarmuid O McMahon, Dublin (IE)

(73) Assignee: **Le Crueset S.A.**, Fresnoy-le-Grand
(FR)

(**) Term: **14 Years**

(21) Appl. No.: **29/187,094**

(22) Filed: **Jul. 28, 2003**

(30) **Foreign Application Priority Data**

Jan. 31, 2003 (GB) 3010562

(51) **LOC (7) Cl.** **07-99**

(52) **U.S. Cl.** **D8/41**

(58) **Field of Search** D8/16-20, 33-35,
D8/38-43, 88, 89, 105; 7/138, 151-166;
30/1.5, 169, 400-450; 81/3.05-3.49; 294/15

(56) **References Cited**

U.S. PATENT DOCUMENTS

D297,201 S * 8/1988 Allen D8/41

D422,861 S * 4/2000 Hollinger D8/41
D459,174 S 6/2002 De Bergen
D459,963 S * 7/2002 Usbeck D8/41

* cited by examiner

Primary Examiner—Caron D. Veynar

(74) *Attorney, Agent, or Firm*—Gary L. Bush; Andrews
Kurth LLP

(57) **CLAIM**

The ornamental design for a foil cutter, as shown.

DESCRIPTION

FIG. 1 is a perspective view from the top of the foil cutter
of this new design;

FIG. 2 is a perspective view from underneath the foil cutter
of FIG. 1;

FIG. 3 is a front view of the foil cutter of FIG. 1;

FIG. 4 is a top view of the foil cutter of FIG. 1;

FIG. 5 is a side view from the left side of FIG. 1;

FIG. 6 is a side view from the right side of FIG. 1; and,

FIG. 7 is a bottom view of the foil cutter of FIG. 1.

1 Claim, 3 Drawing Sheets

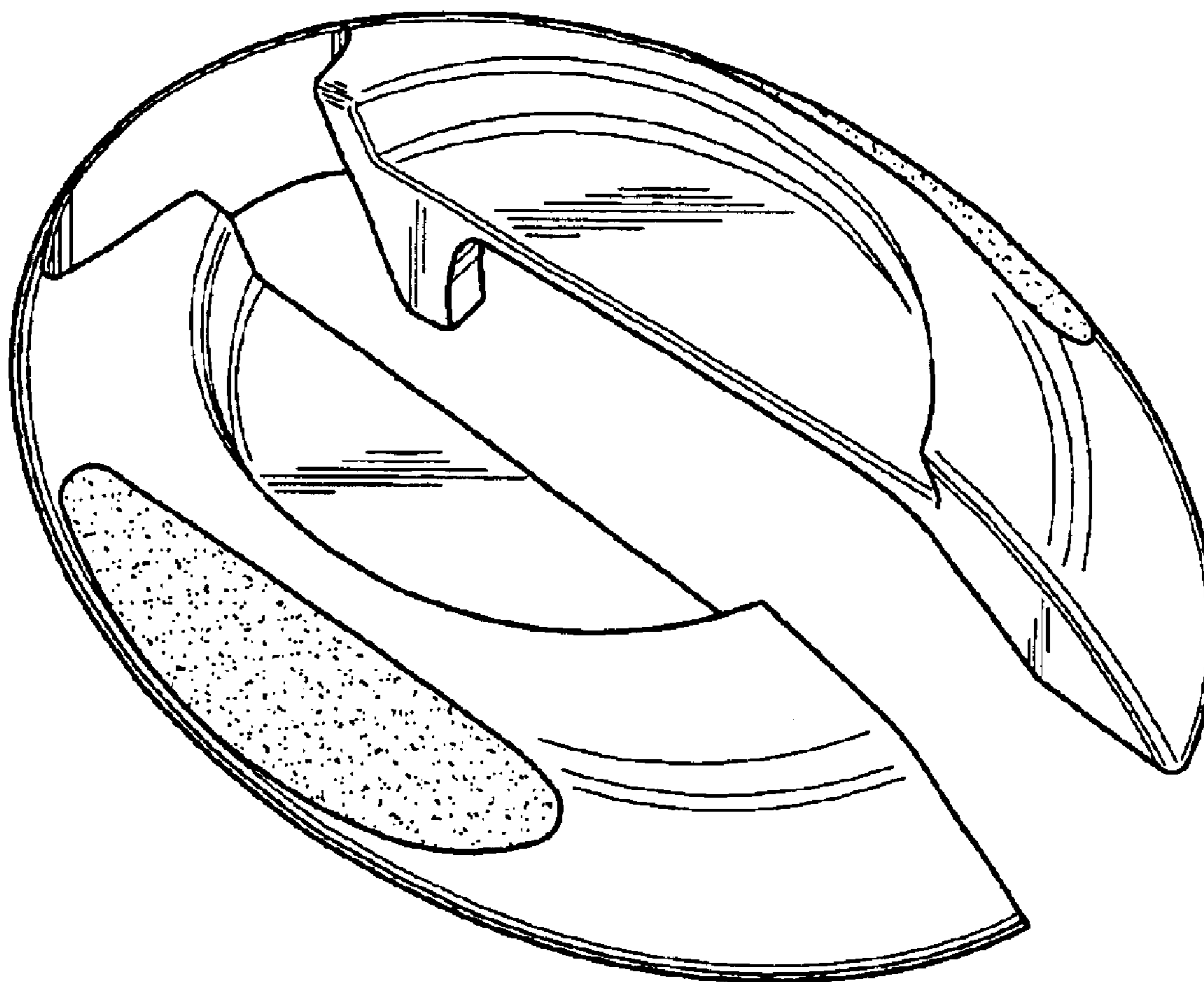

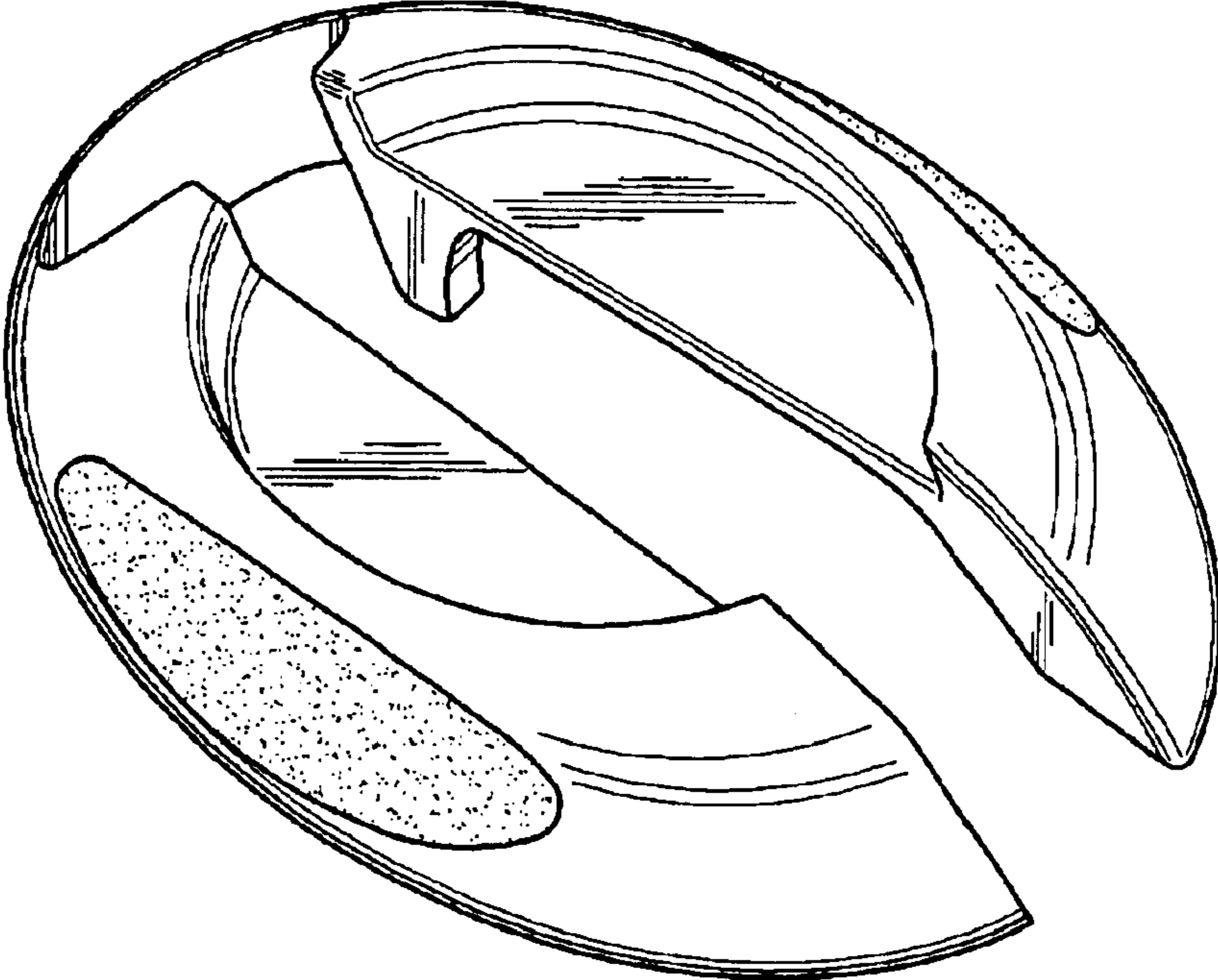

FIG. 1

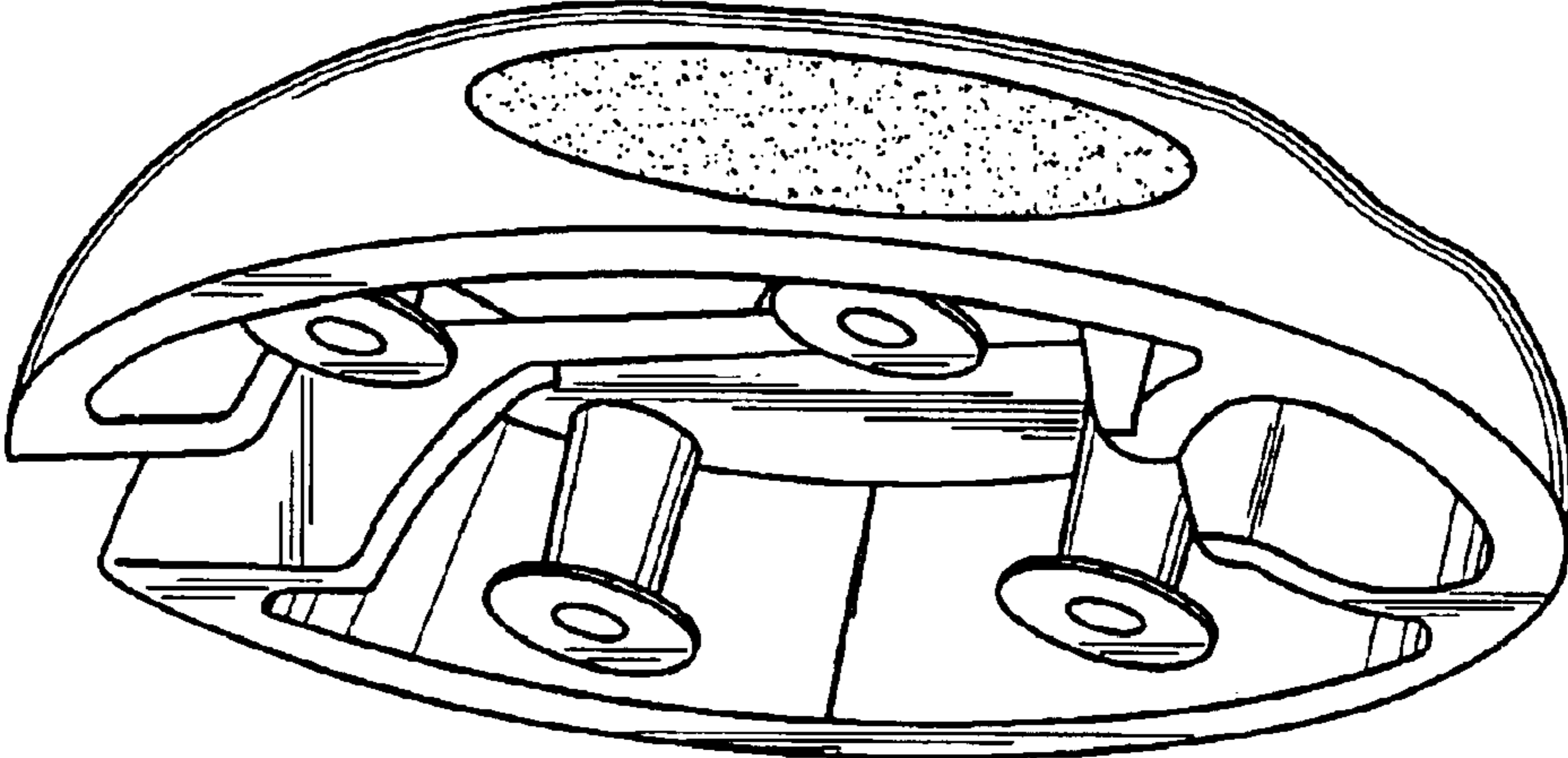

FIG. 2

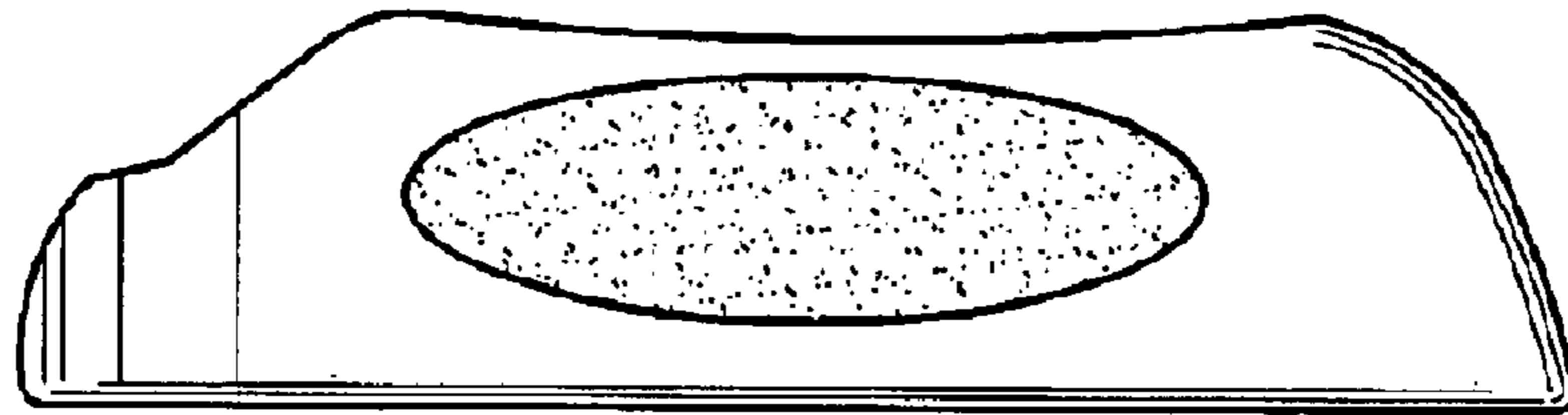

FIG. 3

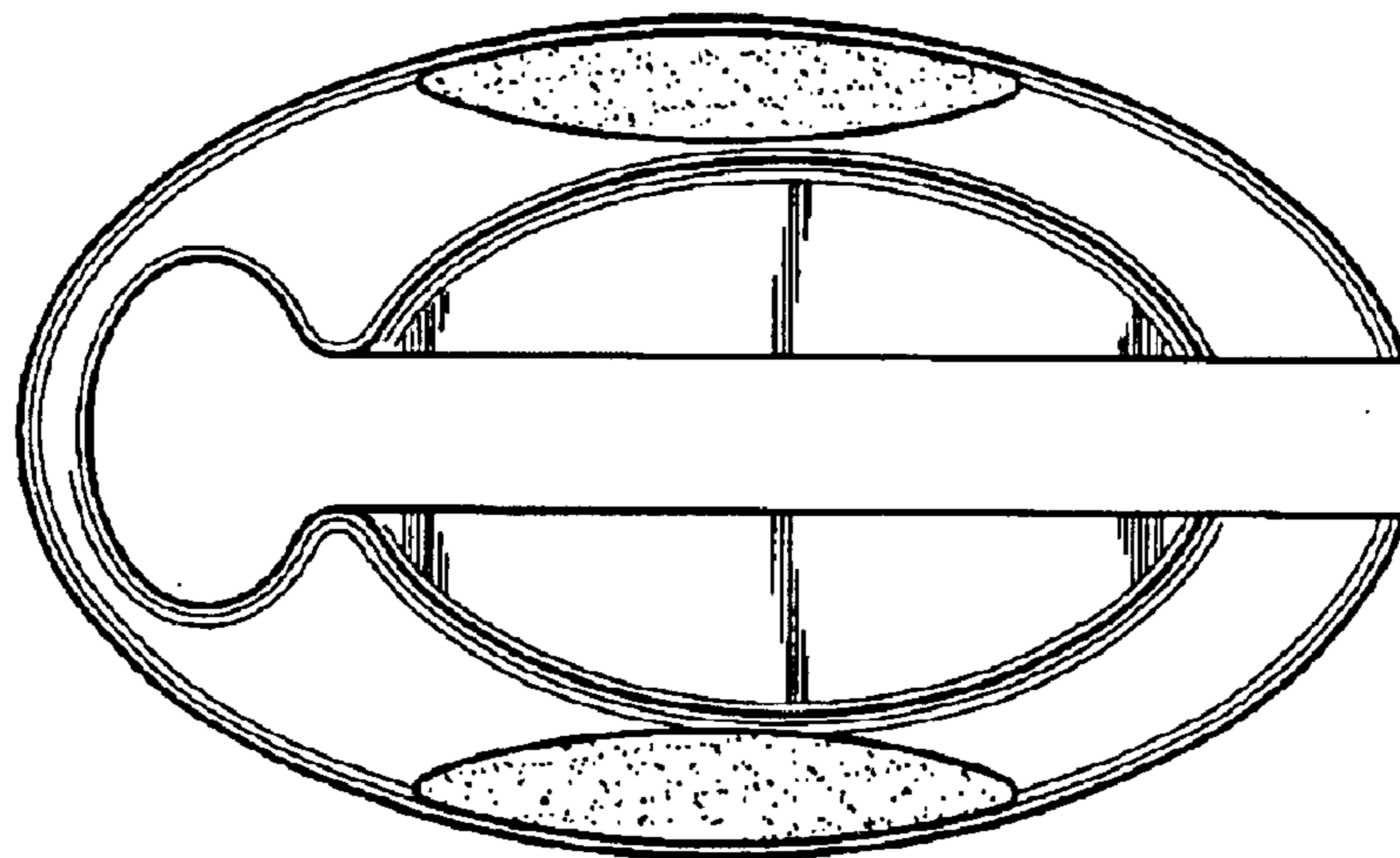

FIG. 4

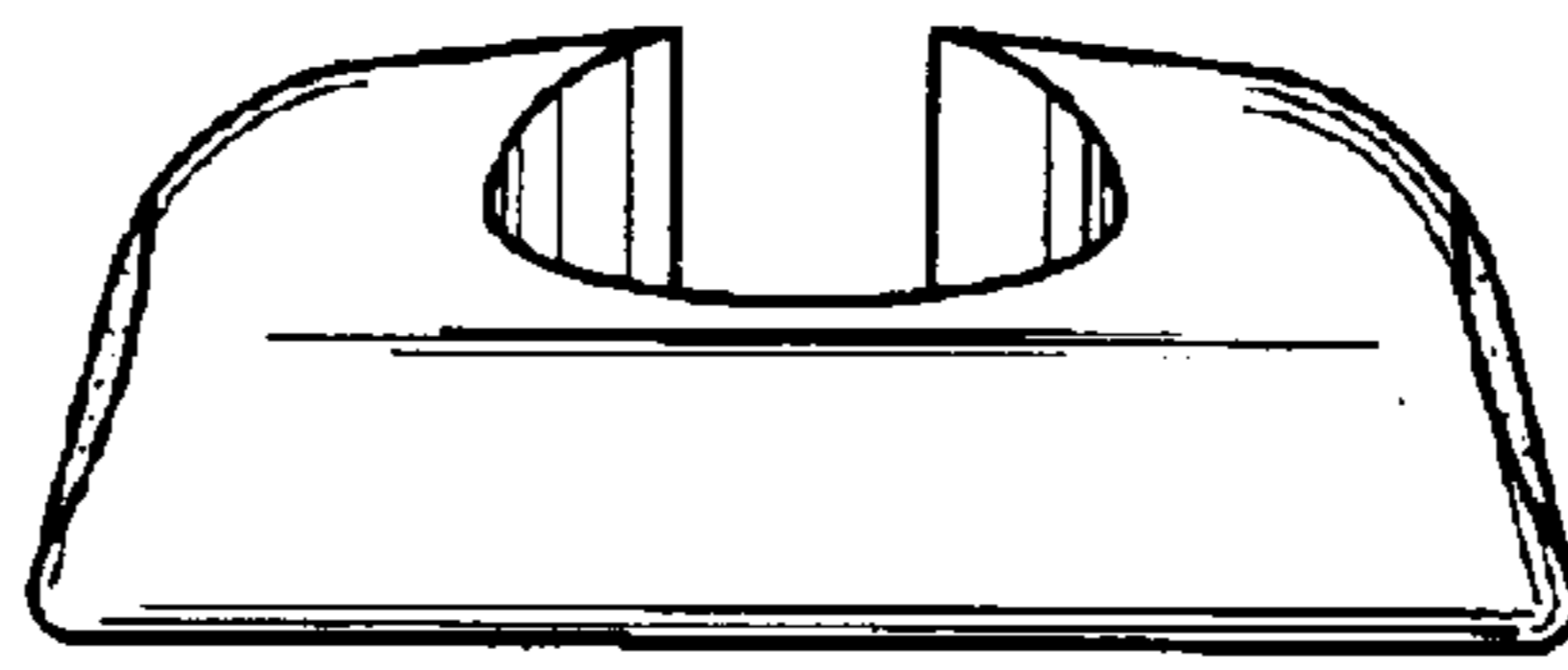

FIG. 5

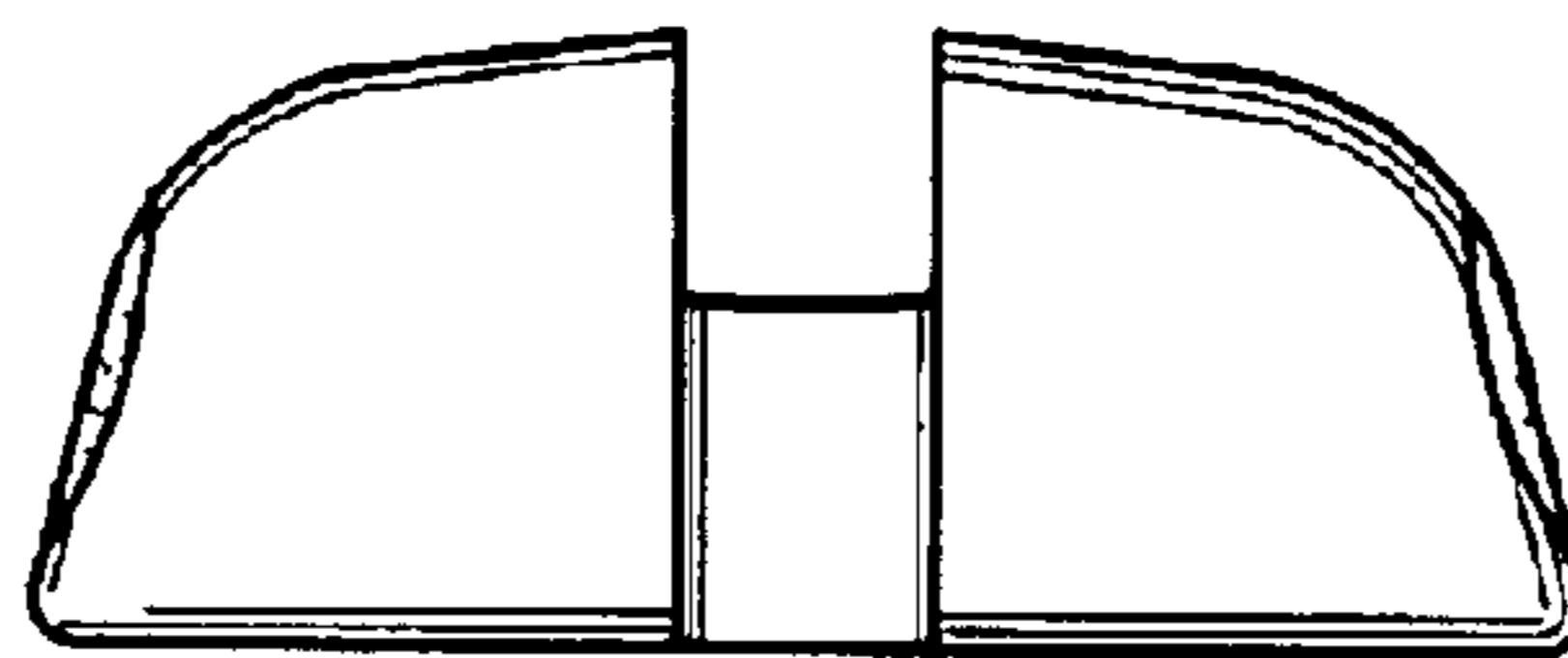

FIG. 6

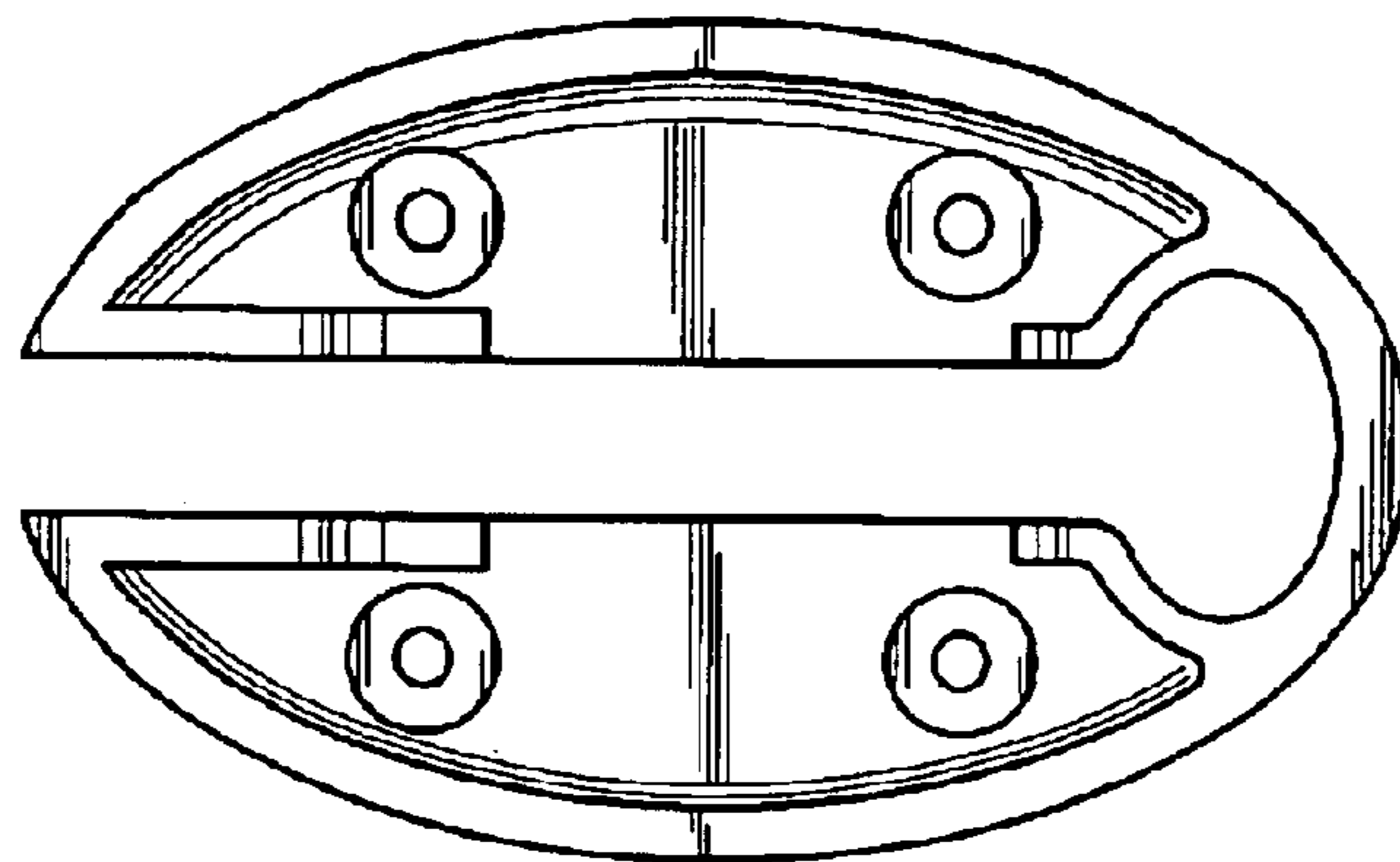

FIG. 7