



US00D501773S

(12) **United States Design Patent**  
**Kohn**

(10) **Patent No.:** **US D501,773 S**

(45) **Date of Patent:** **\*\* Feb. 15, 2005**

(54) **PAINT CAN LID OPENER**

(76) **Inventor:** **Peter Kohn**, 162-21 Powell Cove  
Blvd., Whitestone, NY (US) 11357

(\*\*) **Term:** **14 Years**

(21) **Appl. No.:** **29/185,725**

(22) **Filed:** **Jul. 2, 2003**

(51) **LOC (7) Cl.** ..... **07-99**

(52) **U.S. Cl.** ..... **D8/40; D8/18**

(58) **Field of Search** ..... D8/16-20, 33-35,  
D8/38-43, 88, 89, 105; 7/138, 151-166;  
30/1.5, 169, 400-450; 81/3.05-3.49; 294/15

(56) **References Cited**

**U.S. PATENT DOCUMENTS**

D245,393 S	*	8/1977	Madsen et al.	.....	D8/18
D254,834 S	*	4/1980	Madsen et al.	.....	D8/18
4,658,455 A	*	4/1987	Skillern	.....	7/151
D296,411 S	*	6/1988	Madsen et al.	.....	D8/18
D304,992 S		12/1989	Matthies	.....	D8/40

D308,322 S	*	6/1990	Borden	.....	D8/40
4,967,436 A	*	11/1990	Russell	.....	7/156
5,069,090 A	*	12/1991	Clark	.....	81/3.09
D382,453 S	*	8/1997	Drinkwater	.....	D8/40

\* cited by examiner

*Primary Examiner*—Caron D. Veynar

(74) *Attorney, Agent, or Firm*—Goldstein Law Offices, P.C.

(57) **CLAIM**

The ornamental design for a paint can lid opener, as shown and described.

**DESCRIPTION**

FIG. 1 is a perspective view of a paint can lid opener.  
FIG. 2 is a front elevational view thereof, the rear elevational view being a mirror image of the front view.  
FIG. 3 is a top plan view thereof.  
FIG. 4 is a bottom plan view thereof.  
FIG. 5 is a right side elevational view thereof; and,  
FIG. 6 is a left side elevational view thereof.

**1 Claim, 3 Drawing Sheets**

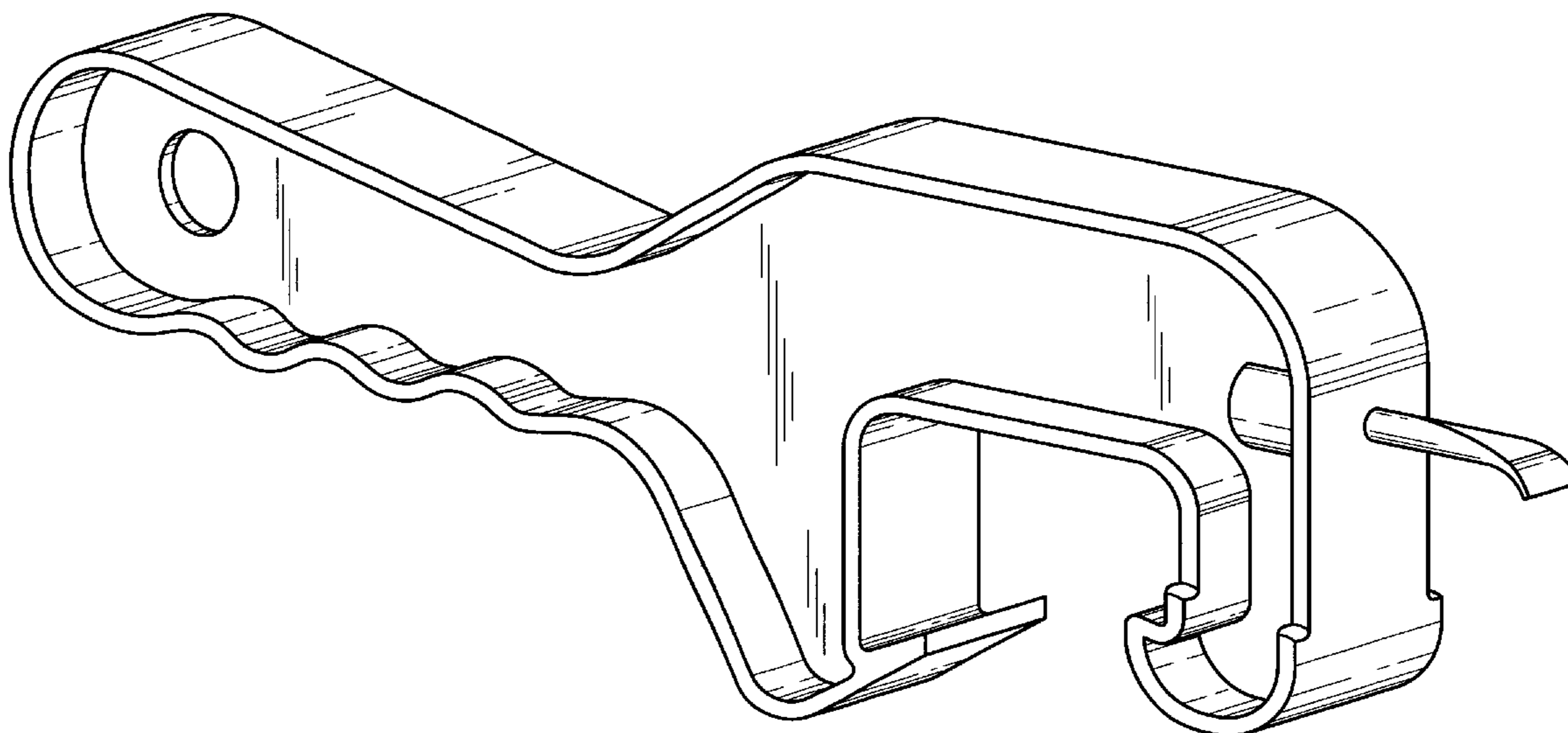

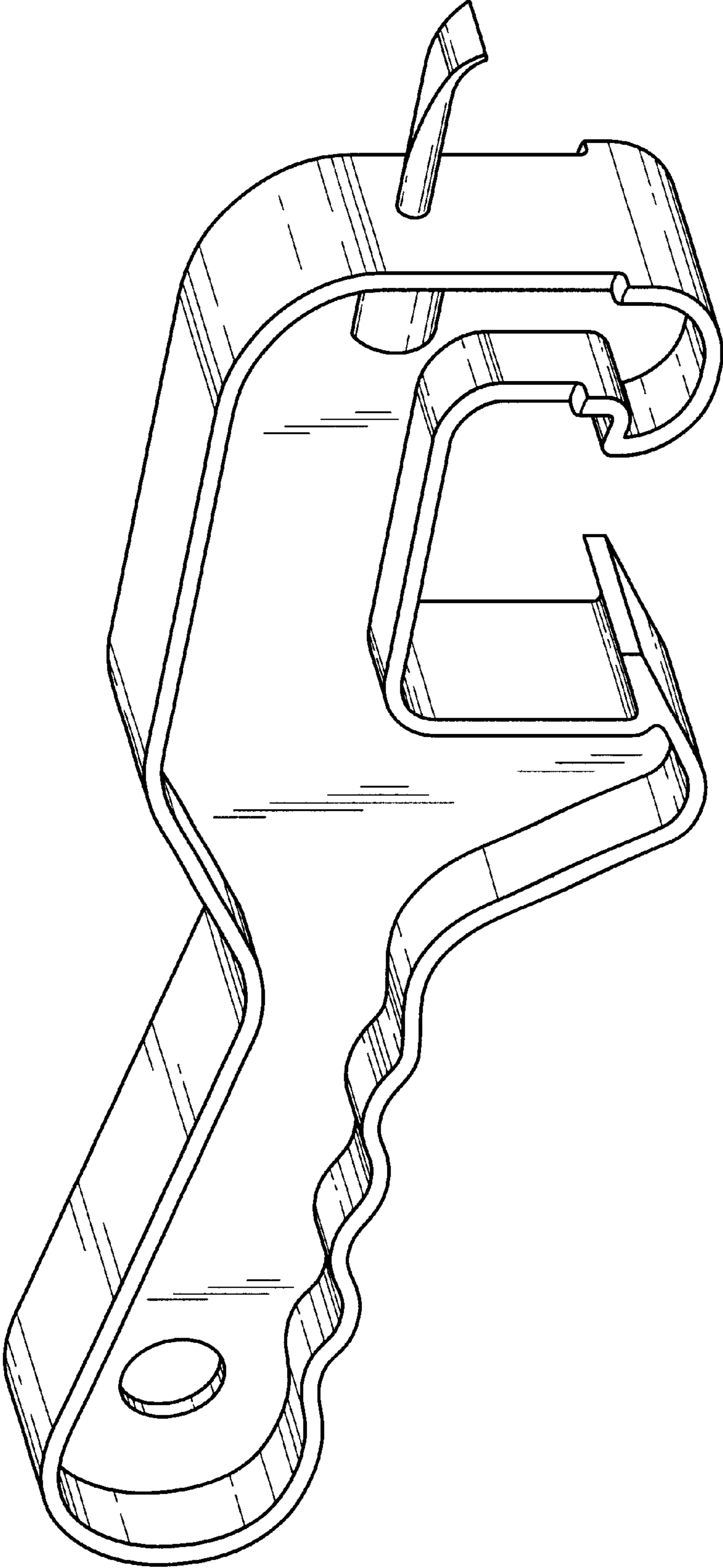

FIG. 1

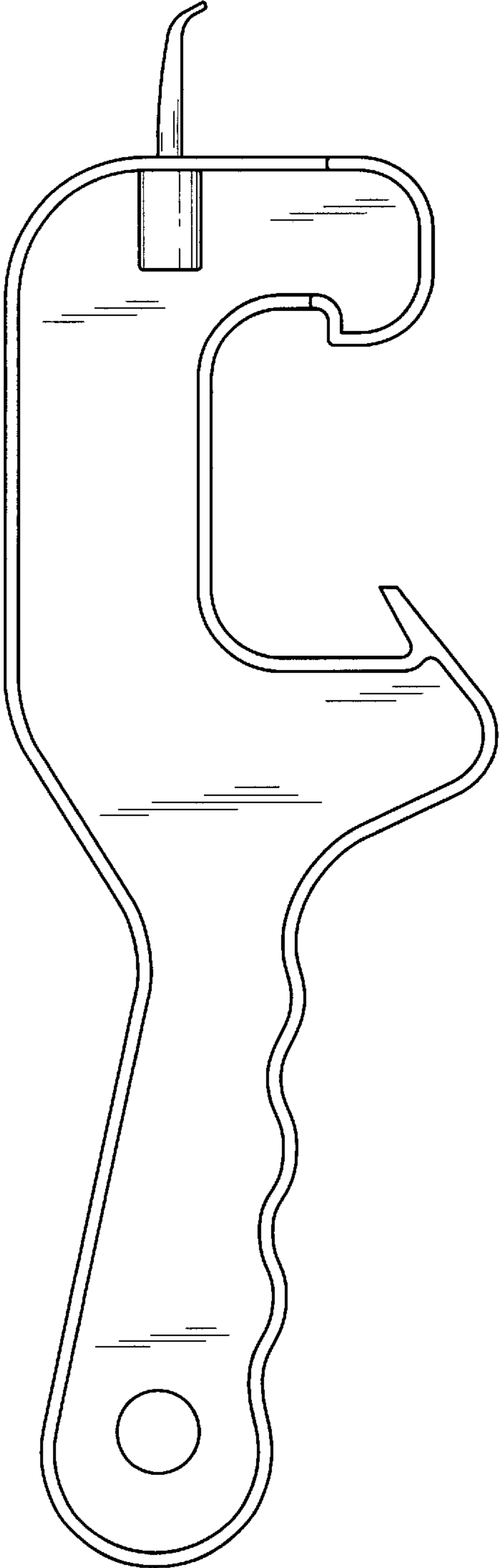

FIG. 2

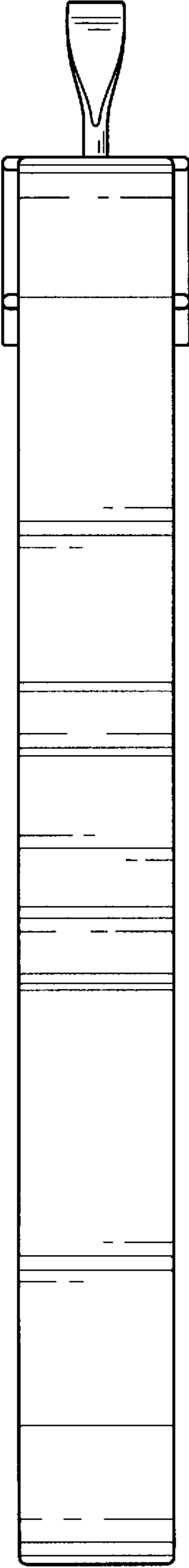

FIG. 3

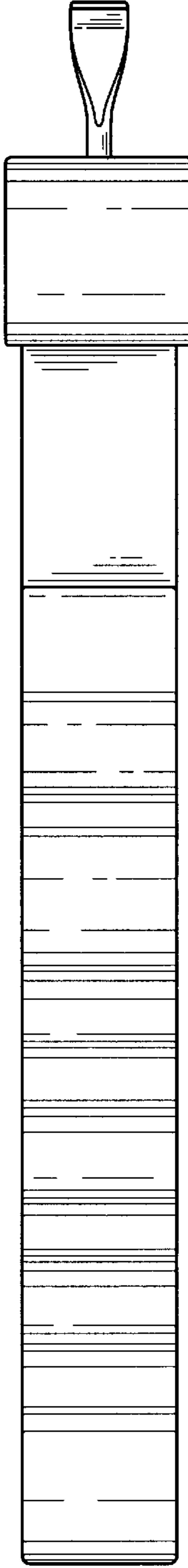

FIG. 4

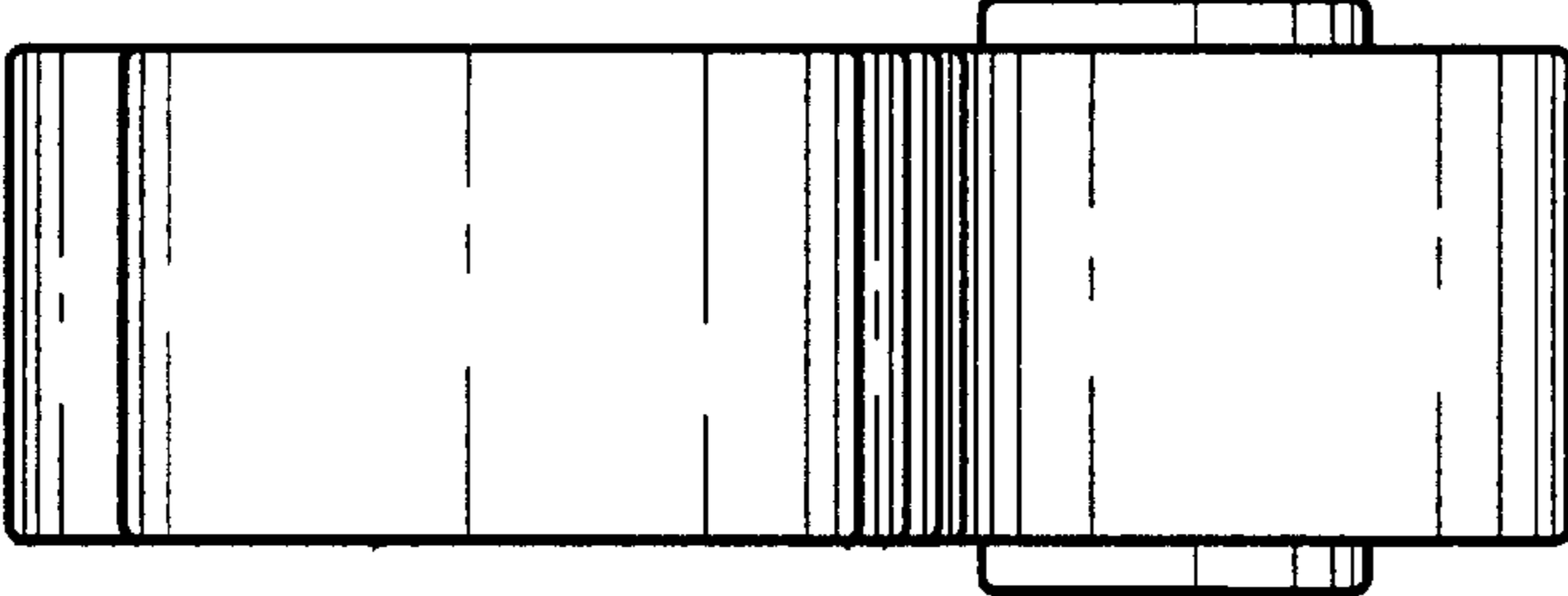

FIG. 6

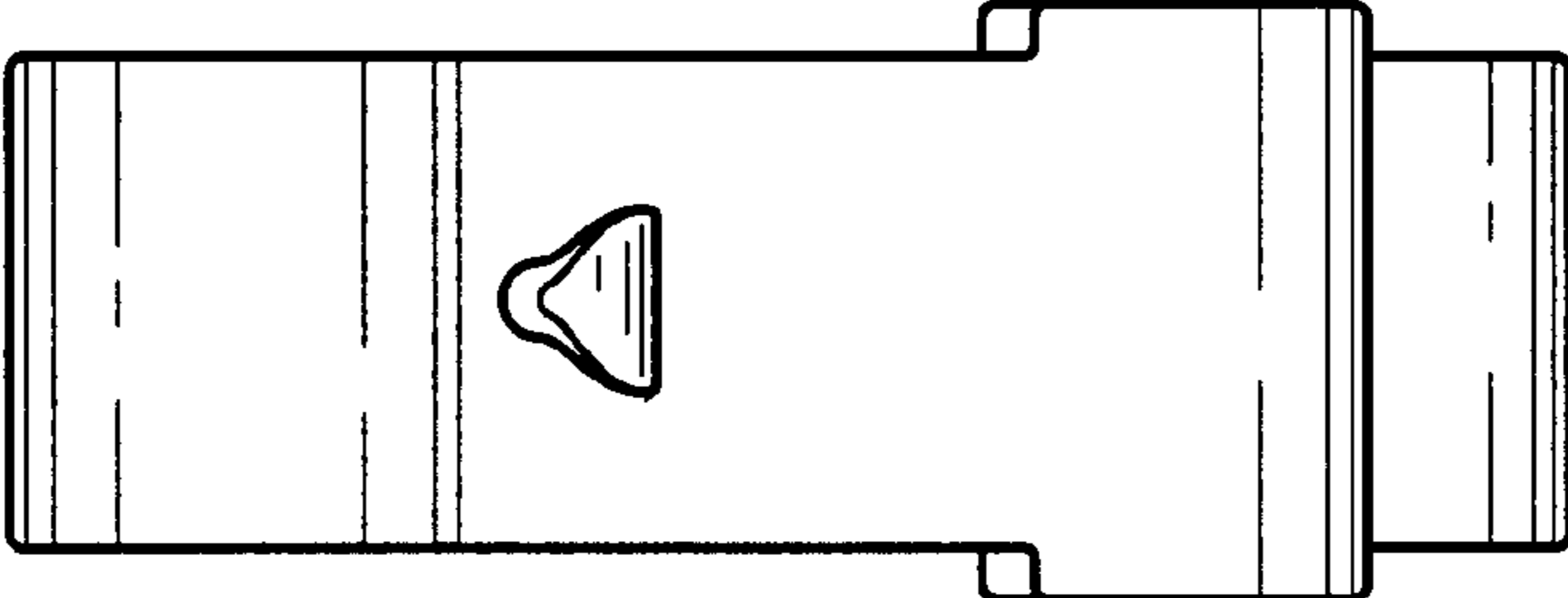

FIG. 5